

Toestelcontactstop

Bestelnr. 749



- schroefklemmen
- hittebestendig binnenwerk
- vernikkelde contacten

Technische informatie

Ampère	16 A
Polen	7 p
Voltage	230 V
Uurstand	9 h
Hertz	50-60 Hz
Aansluittechniek	schroefklemmen
Contacten	vernikkelde contacten, hittebestendig binnenwerk
Beschermingsgraad	IP 44
Gewicht	204 g
Certificeringen	EAC, CQC

Tekeningen

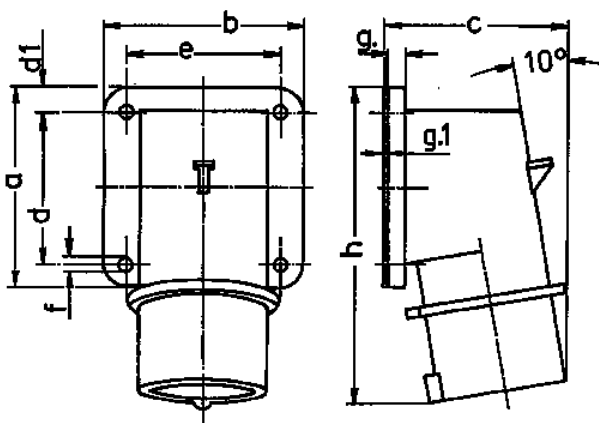

Tekening	Amp.	16	32
2 MB 71	Polen	7	7
Maten in mm	a	85	75
	b	85	90
	c	79	90
	d	64	45
	d1	10	13
	e	64	78
	f	5,5	5,5
	g.	6	6
	g.1	2	2
	h	129	138
Kabelaansluiting			
van/tot mm²		1	2,5
		-2,5	-6