

Inbouwcontactdoos

Bestelnr. 1147A



- schroefklemmen
- X-CONTACT®
- 20° hoek
- producten met lange bussen en pilootcontactbus op aanvraag

Technische informatie

Ampère	63 A
Polen	3 p
Voltage	230 V
Uurstand	6 h
Hertz	50-60 Hz
Aansluittechniek	schroefklemmen
Contacten	hittebestendig binnenwerk, X-CONTACT®
Beschermingsgraad	IP 44
Flens	110x106 mm
Bevestigingsgaten	85x77 mm
Hoek	20°
Gewicht	526 g
Certificeringen	VDE, EAC, CQC

Tekeningen

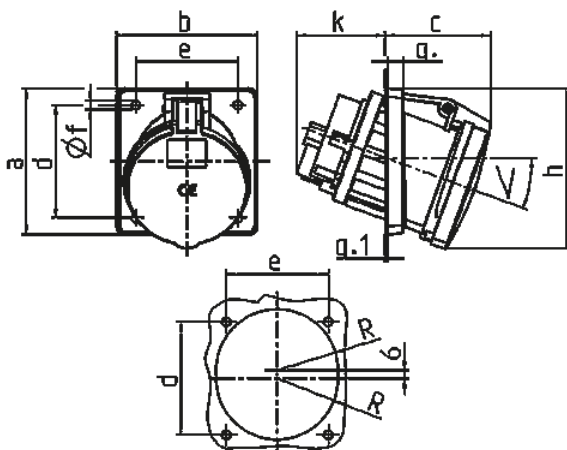

Tekening	Amp.	63		
		Polen		
1 MB 297				
Maten in mm				
a		110	110	110
b		106	106	106
c		82	82	82
d		85	85	85
e		77	77	77
f		6,5	6,5	6,5
g		12	12	12
g.1		2	2	2
h		122	122	122
k		69	69	69
R		46	46	46
<		20°	20°	20°
Kabelaansluiting van/tot mm²				
		6	6	6
		—25	—25	—25