



STAGO – Gaines & chemins de câbles design

Des solutions élégantes pour la gestion des câbles dans l'intérieur





Les gaines à câbles STAGO

Une touche d'originalité dans tout intérieur moderne et industriel !

Les gaines à câbles constituent une partie importante de l'installation électrique. Après tout, les câbles doivent être guidés à travers le bâtiment de manière simple. La flexibilité et la facilité de montage sont des caractéristiques essentielles pour un tel système de porteurs de câbles.

Mais saviez-vous que les gaines à câbles ont également une valeur esthétique ? Alors qu'on les installait auparavant exclusivement au-dessus du faux plafond, elles sont à présent montées de façon apparente selon la tendance du look industriel.

La gamme des gaines à câbles STAGO en versions métalliques et laquées s'intègre parfaitement dans le nouvel intérieur industriel élégant qui regorge de matériaux robustes aux accents métalliques ou laqués. Conformément à cette nouvelle tendance, les bureaux, les magasins, le secteur de la restauration, ainsi que les habitations privées sont équipés de ces gaines à câbles STAGO originales, ce qui permet de parfaitement combiner l'aspect fonctionnel avec le nouveau look industriel.

Les gaines à câbles design STAGO sont disponibles en standard en Sendzimir ("look métallique"), noir industriel RAL9005 et blanc moderne RAL9010. D'autres couleurs RAL sont disponibles sur demande.

Optez pour une installation discrète et élégante avec une couleur qui se fond complètement dans son environnement "ton sur ton", ou choisissez un détail intérieur contrasté qui crée de la vie et une certaine dynamique dans la pièce.



Design et fonctionnalité vont de pair

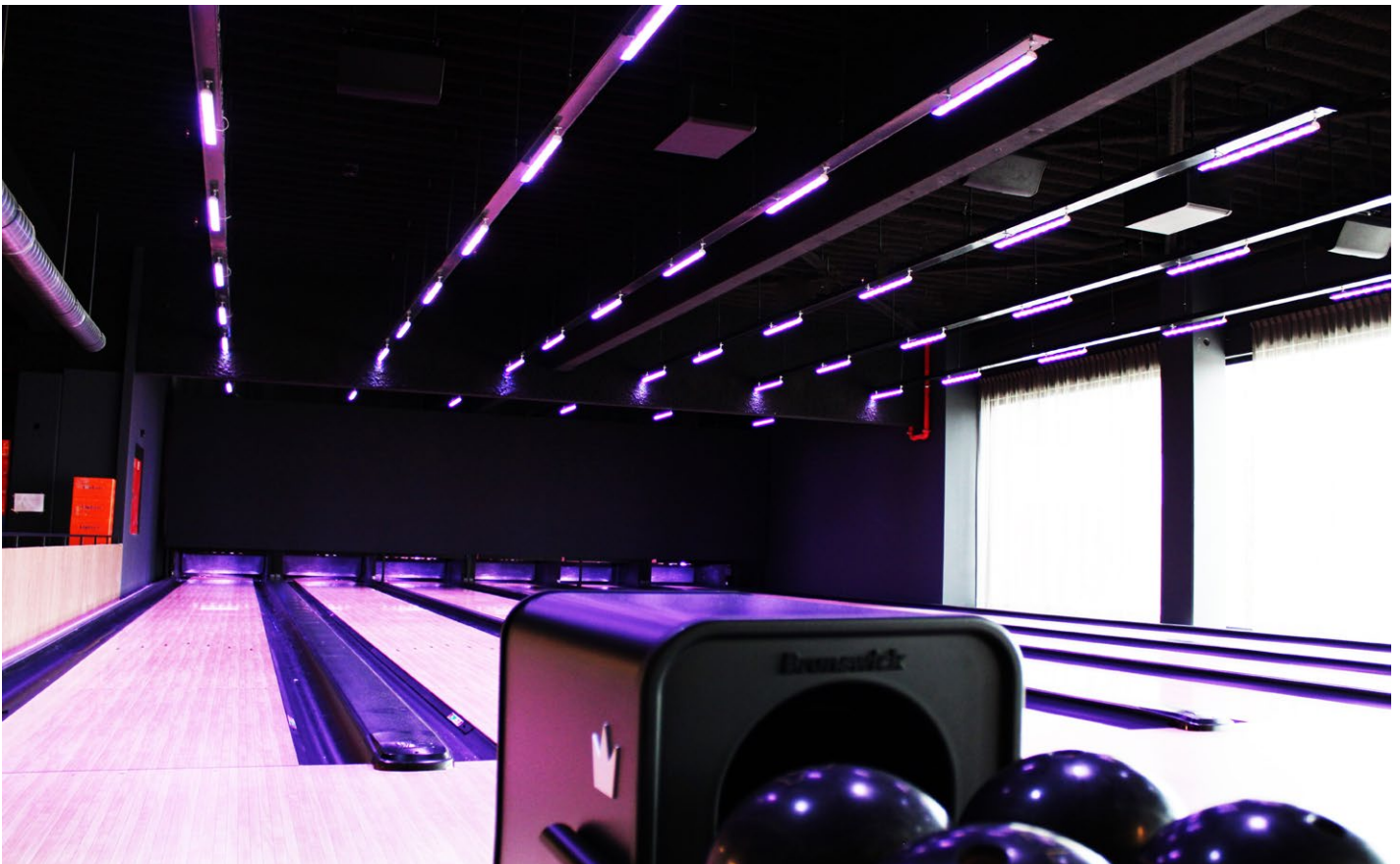

Pourquoi choisir les gaines à câbles STAGO ?

- Fonctionnel
- Élégant - adapté à tout intérieur industriel moderne
- Esthétique et épuré
- Qualitatif
- Disponible en stock en trois finitions : métallique, laqué noir et laqué blanc
- Un système complet de gaines à câbles, de raccords, de suspensions et autres accessoires pour une gestion rapide et facile des câbles
- Optimisé pour les bâtiments commerciaux tels que les bureaux, les centres commerciaux, etc. (classes de corrosion C1 & C2)

Aperçu général

- 1A – Gaine à câbles KG 281 non perforée
- 1B – Gaine à câbles KG 281 avec perforations latérales
- 1C – Gaine à câbles KG 281 avec perforations latérales et opercules défonçables
- 1D – Chemin de câbles KB 184

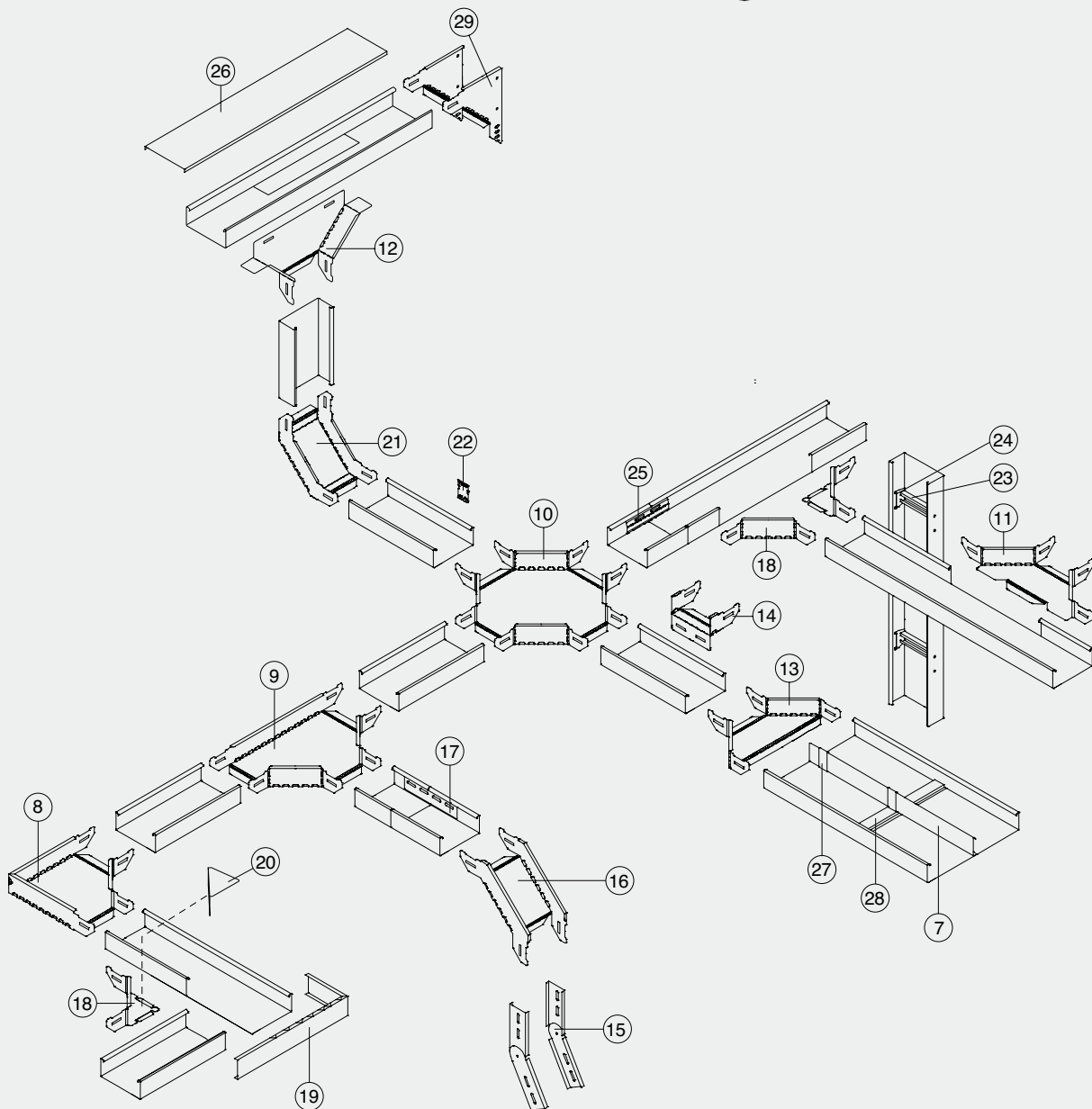
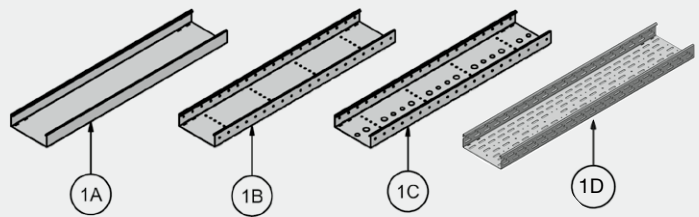

- | | | |
|-------------------------------------------|--------------------------------------------|-------------------------------------|
| 7 - Cloison de séparation | 16 - Raccord de descente | 23 - Echelon |
| 8 - Pièce d'angle | 17 - Accouplement | 24 - Fixation pour échelon |
| 9 - Pièce en T | 18 - Dérivation universelle | 25 - Accouplement sans vis |
| 10 - Croisillon | 19 - Accouplement / pièce de réduction | 26 - Couvercle |
| 11 - Dérivation | 20 - Couvercle pour dérivation universelle | 27 - Verrou pour cloison |
| 12 - Pièce murale verticale | 21 - Raccord de montée | 28 - Etrier de fond |
| 13 - Réduction | 22 - Fixation pour accessoire | 29 - Pièce en T verticale terminale |
| 14 - Dérivation surélevée | | |
| 15 - Raccord de descente: montée réglable | | |

Aperçu général

- 1 - Gaine à câbles à parois latérales perforées
- 2 - Gaine à câbles avec opercules défonçables
- 3 - Gaine à câbles non perforées
- 4 - Plaque de montage universelle
- 5 - Echelon
- 6 - Fixation pour échelon
- 7 - Plaque de montage emboutie
- 8 - Accouplement sans vis
- 9 - Fixation pour accessoire
- 11 - Dispositif de verrouillage
- 12 - Cloison de séparation
- 13 - Accouplement
- 14 - Etrier de fond
- 15 - Attache couvercle
- 16 - Couvercle
- 17 - Attache universelle pour couvercle
- 18 - Attache extérieure pour couvercle

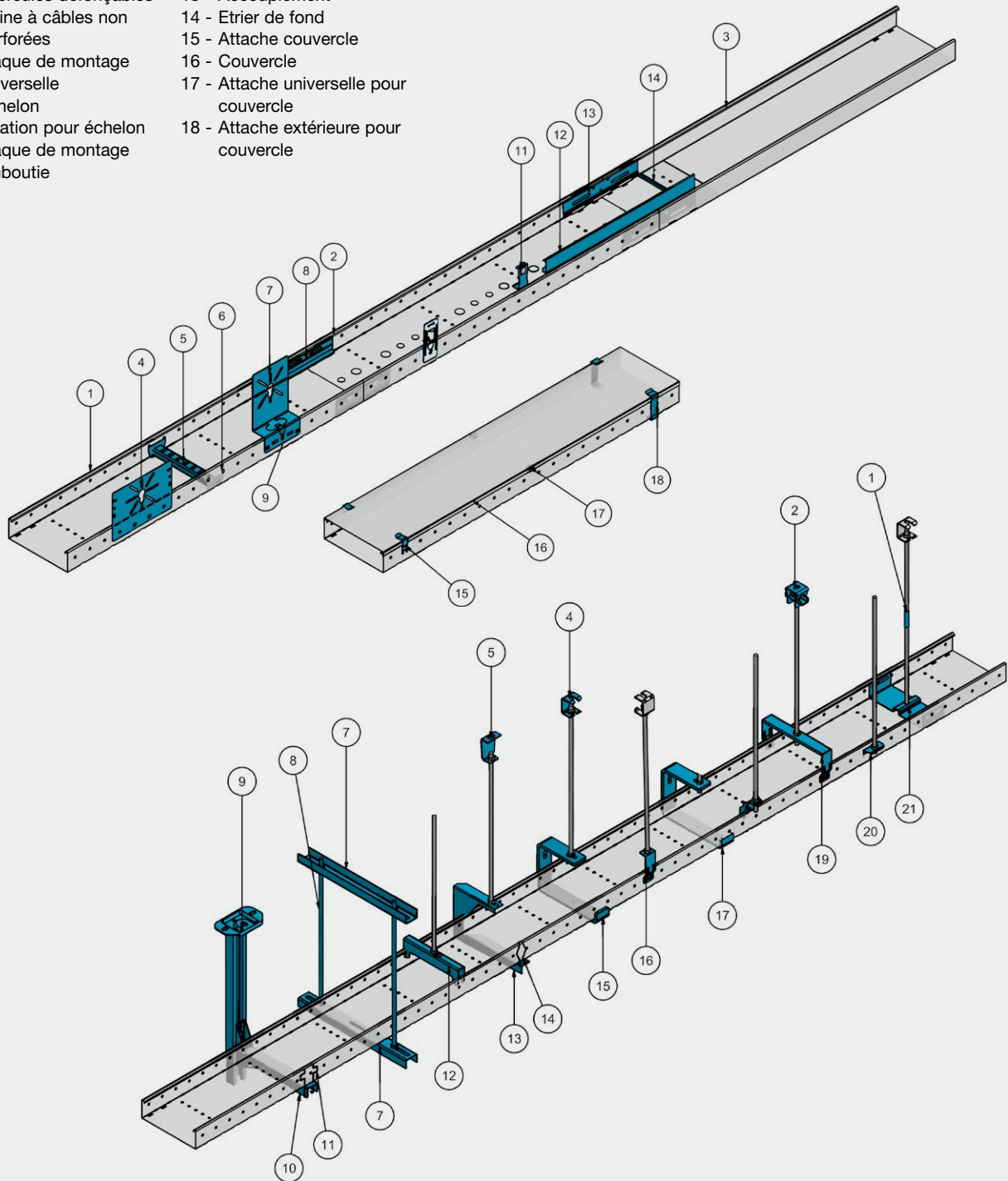

- 1 - Ecrou de rallonge
- 10 - Console 50i
- 19 - Etrier supérieur pour porteur de câbles avec couvercle
- 2 - Etrier de plafond
- 11 - Ressort
- 20 - Etrier pour perforation latérale
- 4 - Etrier de plafond ouvert
- 12 - Etrier supérieur
- 21 - Etrier intérieur
- 5 - Etrier de plafond
- 13 - Etrier en C extérieur
- 7 - Profilé de support
- 14 - Ressort
- 8 - Tige filetée M10
- 15 - Etrier en C
- 9 - Pendard 2F
- 16 - Etrier de suspension
- 17 - Etrier en C

STAGO KG 281 – KB 184

Gaine à câbles à parois latérales perforées

Ep = 1 mm
L = 3 m

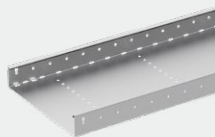

G.S.

RAL 9010

RAL 9005

	G.S.	RAL 9010	RAL 9005
60x70	8601204	8601204UP9010N	8601204UP9005N
60x120	8602204	8602204UP9010N	8602204UP9005N
60x200	8603204	8603204UP9010N	8603204UP9005N
60x250	8604204	8604204UP9010N	8604204UP9005N
60x330	8605204	8605204UP9010N	8605204UP9005N
60x400	8606204	8606204UP9010N	8606204UP9005N

Gaine à câbles non perforée

Ep = 1 mm
L = 3 m

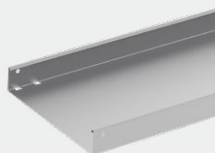

G.S.

RAL 9010

RAL 9005

	G.S.	RAL 9010	RAL 9005
60x70	8601404	8601404UP9010N	8601404UP9005N
60x120	8602404	8602404UP9010N	8602404UP9005N
60x200	8603404	8603404UP9010N	8603404UP9005N
60x250	8604404	8604404UP9010N	8604404UP9005N
60x330	8605404	8605404UP9010N	8605404UP9005N

Chemin de câbles

Ep = 1 mm
L = 3 m

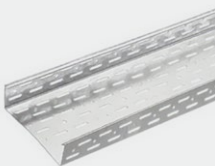

G.S.

RAL 9010

RAL 9005

	G.S.	RAL 9010	RAL 9005
60x400	76014004	76014004UP9010N	76014004UP9005N
60x500	76015004	76015004UP9010N	76015004UP9005N
60x600	76016004	76016004UP9010N	76016004UP9005N

Accouplement Unilock

Pour les porteurs Ep = 0,8 mm
et Ep = 1 mm, L = 174 mm



G.S.

[8010109](#)

Cloison de séparation

Pour montage avec verrou
L = 2995 mm

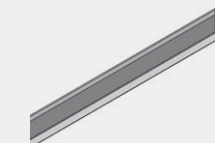

G.S.

[88701](#)

Verrou pour cloison de séparation

Pour la fixation par clic de
cloison de séparation



G.S.

[88705](#)



Légende

E.Z.	Zingage électrolytique NBN EN ISO 2081
G.S.	Galvanisation Sendzimir NBN EN 10346
H.D.	Galvanisation à chaud NBN EN ISO 1461

Couvercle

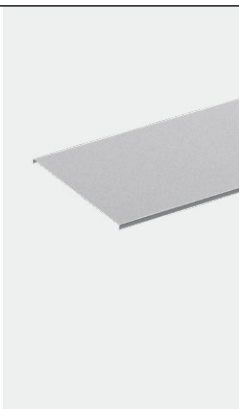
L = 2 m





	 G.S.	 RAL 9010	 RAL 9005
70	8161003	8161003UP9010N	8161003UP9005N
120	8162003	8162003UP9010N	8162003UP9005N
200	8163003	8163003UP9010N	8163003UP9005N
250	8164003	8164003UP9010N	8164003UP9005N
330	8165004	8165004UP9010N	8165004UP9005N
400	8166004	8166004UP9010N	8166004UP9005N
500	8167004	8167004UP9010N	8167004UP9005N
600	8168004	8168004UP9010N	8168004UP9005N

Pièce d'angle

90°





	 G.S.*	 RAL 9010	 RAL 9005
60x70	36060702	36060702UP9010N	36060702UP9005N
60x120	36061202	36061202UP9010N	36061202UP9005N
60x200	36062002	36062002UP9010N	36062002UP9005N
60x250	36062502	36062502UP9010N	36062502UP9005N
60x330	36063302	36063302UP9010N	36063302UP9005N
60x400	36064002	36064002UP9010N	36064002UP9005N
60x500	36065002	36065002UP9010N	36065002UP9005N
60x600	36066002	36066002UP9010N	36066002UP9005N

Couvercle pour pièce d'angle



90°



	 G.S.	 RAL 9010	 RAL 9005
70	30060702	30060702UP9010N	30060702UP9005N
120	30061202	30061202UP9010N	30061202UP9005N
200	30062002	30062002UP9010N	30062002UP9005N
250	30062502	30062502UP9010N	30062502UP9005N
330	30063302	30063302UP9010N	30063302UP9005N
400	30064002	30064002UP9010N	30064002UP9005N
500	30065002	30065002UP9010N	30065002UP9005N
600	30066002	30066002UP9010N	30066002UP9005N

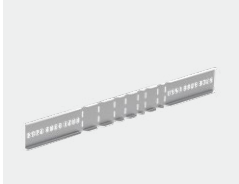

Accouplement

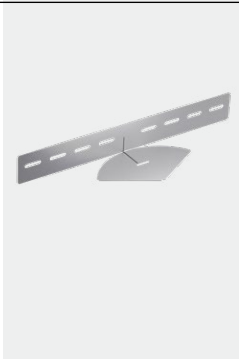

	 G.S.	 RAL 9010	 RAL 9005
60x605	8940000	8940000UP9010N	8940000UP9005N
60x957	8960000	8960000UP9010N	8960000UP9005N

Pièce d'angle réglable



	 G.S.	 RAL 9010	 RAL 9005
60x70	36520702	36520702IUP9010N	36520702IUP9005N
60x120	36521202	36521202IUP9010N	36521202IUP9005N
60x200	36522002	36522002IUP9010N	36522002IUP9005N
60x250	36522502	36522502IUP9010N	36522502IUP9005N

* Livré à plat

Pièce en T



● G.S.*

● RAL 9010

● RAL 9005

	G.S.*	RAL 9010	RAL 9005
60x70	36150702	36150702UP9010N	36150702UP9005N
60x120	36151202	36151202UP9010N	36151202UP9005N
60x200	36152002	36152002UP9010N	36152002UP9005N
60x250	36152502	36152502UP9010N	36152502UP9005N
60x330	36153302	36153302UP9010N	36153302UP9005N
60x400	36154002	36154002UP9010N	36154002UP9005N
60x500	36155002	36155002UP9010N	36155002UP9005N
60x600	36156002	36156002UP9010N	36156002UP9005N

Couvercle pour pièce en T

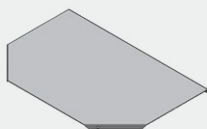

● G.S.

● RAL 9010

● RAL 9005

	G.S.	RAL 9010	RAL 9005
70	30150702	30150702UP9010N	30150702UP9005N
120	30151202	30151202UP9010N	30151202UP9005N
200	30152002	30152002UP9010N	30152002UP9005N
250	30152502	30152502UP9010N	30152502UP9005N
330	30153302	30153302UP9010N	30153302UP9005N
400	30154002	30154002UP9010N	30154002UP9005N
500	30155002	30155002UP9010N	30155002UP9005N
600	30156002	30156002UP9010N	30156002UP9005N

Croisillon



● G.S.*

● RAL 9010

● RAL 9005

	G.S.*	RAL 9010	RAL 9005
60x70	36160702	36160702UP9010N	36160702UP9005N
60x120	36161202	36161202UP9010N	36161202UP9005N
60x200	36162002	36162002UP9010N	36162002UP9005N
60x250	36162502	36162502UP9010N	36162502UP9005N
60x330	36163302	36163302UP9010N	36163302UP9005N
60x400	36164002	36164002UP9010N	36164002UP9005N
60x500	36165002	36165002UP9010N	36165002UP9005N
60x600	36166002	36166002UP9010N	36166002UP9005N

Couvercle pour croisillon

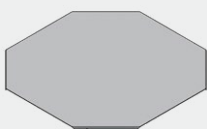

● G.S.

● RAL 9010

● RAL 9005

	G.S.	RAL 9010	RAL 9005
70	30160702	30160702UP9010N	30160702UP9005N
120	30161202	30161202UP9010N	30161202UP9005N
200	30162002	30162002UP9010N	30162002UP9005N
250	30162502	30162502UP9010N	30162502UP9005N
330	30163302	30163302UP9010N	30163302UP9005N

Dérivation surélevée



● G.S.*

● RAL 9010

● RAL 9005

	G.S.*	RAL 9010	RAL 9005
60x70	36510702	36510702UP9010N	36510702UP9005N
60x120	36511202	36511202UP9010N	36511202UP9005N
60x200	36512002	36512002UP9010N	36512002UP9005N
60x250	36512502	36512502UP9010N	36512502UP9005N

* Livré à plat

Dérivation



● G.S.*

● RAL 9010

● RAL 9005

	G.S.*	RAL 9010	RAL 9005
60x70	36070702	36070702UP9010N	36070702UP9005N
60x120	36071202	36071202UP9010N	36071202UP9005N
60x200	36072002	36072002UP9010N	36072002UP9005N
60x250	36072502	36072502UP9010N	36072502UP9005N
60x330	36073302	36073302UP9010N	36073302UP9005N
60x400	36074002	36074002UP9010N	36074002UP9005N
60x500	36075002	36075002UP9010N	36075002UP9005N
60x600	36076002	36076002UP9010N	36076002UP9005N

Couvercle pour dérivation

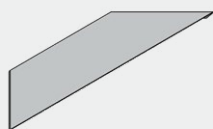

● G.S.

● RAL 9010

● RAL 9005

	G.S.	RAL 9010	RAL 9005
70	30070702	30070702UP9010N	30070702UP9005N
120	30071202	30071202UP9010N	30071202UP9005N
200	30072002	30072002UP9010N	30072002UP9005N
250	30072502	30072502UP9010N	30072502UP9005N
330	30073302	30073302UP9010N	30073302UP9005N
400	30074002	30074002UP9010N	30074002UP9005N
500	30075002	30075002UP9010N	30075002UP9005N
600	30076002	30076002UP9010N	30076002UP9005N

Réduction



● G.S.*

● RAL 9010

● RAL 9005

	G.S.*	RAL 9010	RAL 9005
70-120	36252202	36252202UP9010N	36252202UP9005N
70-200	36252402	36252402UP9010N	36252402UP9005N
70-250	36252602	36252602UP9010N	36252602UP9005N
120-200	36254702	36254702UP9010N	36254702UP9005N
120-250	36254802	36254802UP9010N	36254802UP9005N
200-250	36256402	36256402UP9010N	36256402UP9005N

Couvercle pour réduction



● G.S.

● RAL 9010

● RAL 9005

	G.S.	RAL 9010	RAL 9005
70-120	30252202	30252202UP9010N	30252202UP9005N
70-200	30252402	30252402UP9010N	30252402UP9005N
70-250	30252602	30252602UP9010N	30252602UP9005N
120-200	30254702	30254702UP9010N	30254702UP9005N
120-250	30254802	30254802UP9010N	30254802UP9005N
200-250	30256402	30256402UP9010N	30256402UP9005N

* Livré à plat

Raccord de montée



● G.S.*

● RAL 9010

● RAL 9005

	G.S.*	RAL 9010	RAL 9005
60x70	36230702	36230702UP9010N	36230702UP9005N
60x120	36231202	36231202UP9010N	36231202UP9005N
60x200	36232002	36232002UP9010N	36232002UP9005N
60x250	36232502	36232502UP9010N	36232502UP9005N
60x330	36233302	36233302UP9010N	36233302UP9005N
60x400	36234002	36234002UP9010N	36234002UP9005N
60x500	36235002	36235002UP9010N	36235002UP9005N
60x600	36236002	36236002UP9010N	36236002UP9005N

Couvercle pour raccord de montée

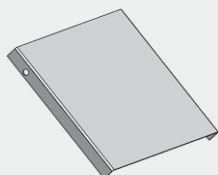

● G.S

● RAL 9010

● RAL 9005

	G.S	RAL 9010	RAL 9005
70	30230702	30230702UP9010N	30230702UP9005N
120	30231202	30231202UP9010N	30231202UP9005N
200	30232002	30232002UP9010N	30232002UP9005N
250	30232502	30232502UP9010N	30232502UP9005N
330	30233302	30233302UP9010N	30233302UP9005N
400	30234002	30234002UP9010N	30234002UP9005N
500	30235002	30235002UP9010N	30235002UP9005N
600	30236002	30236002UP9010N	30236002UP9005N

Raccord de descente



● G.S.*

● RAL 9010

● RAL 9005

	G.S.*	RAL 9010	RAL 9005
60x70	36220702	36220702UP9010N	36220702UP9005N
60x120	36221202	36221202UP9010N	36221202UP9005N
60x200	36222002	36222002UP9010N	36222002UP9005N
60x250	36222502	36222502UP9010N	36222502UP9005N
60x330	36223302	36223302UP9010N	36223302UP9005N
60x400	36224002	36224002UP9010N	36224002UP9005N
60x500	36225002	36225002UP9010N	36225002UP9005N
60x600	36226002	36226002UP9010N	36226002UP9005N

Couvercle pour raccord de descente

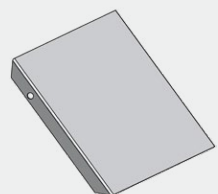

● G.S

● RAL 9010

● RAL 9005

	G.S	RAL 9010	RAL 9005
70	30220702	30220702UP9010N	30220702UP9005N
120	30221202	30221202UP9010N	30221202UP9005N
200	30222002	30222002UP9010N	30222002UP9005N
250	30222502	30222502UP9010N	30222502UP9005N
330	30223302	30223302UP9010N	30223302UP9005N
400	30224002	30224002UP9010N	30224002UP9005N
500	30225002	30225002UP9010N	30225002UP9005N
600	30226002	30226002UP9010N	30226002UP9005N

* Livré à plat

Raccord de descente et de montée

Livré par set (gauche/droite)



G.S

RAL 9010

RAL 9005

[8750000](#)

[8750000IUP9010N](#)

[8750000IUP9005N](#)

Pièce terminale



G.S

RAL 9010

RAL 9005

60x70

[36180704](#)

[36180704UP9010N](#)

[36180704UP9005N](#)

60x120

[36181204](#)

[36181204UP9010N](#)

[36181204UP9005N](#)

60x200

[36182004](#)

[36182004UP9010N](#)

[36182004UP9005N](#)

60x250

[36182504](#)

[36182504UP9010N](#)

[36182504UP9005N](#)

60x330

[36183304](#)

[36183304UP9010N](#)

[36183304UP9005N](#)

60x400

[36184004](#)

[36184004UP9010N](#)

[36184004UP9005N](#)

60x500

[36185004](#)

[36185004UP9010N](#)

[36185004UP9005N](#)

60x600

[36186004](#)

[36186004UP9010N](#)

[36186004UP9005N](#)

Plaque de montage universelle



G.S

RAL 9010

RAL 9005

[8090109](#)

[8090109IUP9010N](#)

[8090109IUP9005N](#)

Plaque de montage



G.S

RAL 9010

RAL 9005

Plate

[8250109](#)

[8250109IUP9010N](#)

[8250109IUP9005N](#)

Pliée

[8250209](#)

[8250209IUP9010N](#)

[8250209IUP9005N](#)

Fixation murale



G.S

RAL 9010

RAL 9005

60x100

[CSU14450100](#)

[CSU14450170](#)

[CSU1445010905](#)

Etrier supérieur



G.S

RAL 9010

RAL 9005

70

[86510](#)

[86510IUP9010N](#)

[86510IUP9005N](#)

120

[86520](#)

[86520IUP9010N](#)

[86520IUP9005N](#)

200

[86530](#)

[86530IUP9010N](#)

[86530IUP9005N](#)

250

[86540](#)

[86540IUP9010N](#)

[86540IUP9005N](#)

Etrier intérieur



● G.S

70	8140709
120	8141209
200	8142009
250	8142509
330	8143309

Etrier en C à zingage électrolytique (600 N)



● E.Z.

● RAL 9010

● RAL 9005

70	CEZ070	CSU08171279	CSU0817129905
120	CEZ120	CSU08172279	CSU0817229905
200	CEZ200	CSU08173279	CSU0817329905
250	CEZ250	CSU08174279	CSU0817429905
330	CEZ330	CSU08175279	CSU0817529905
400	CEZ400	CSU08176279	CSU0817629905

Etrier en C renforcé galvanisé à chaud



● H.D.

● RAL 9010

● RAL 9005

400	CSU14174000	CSU14174070	CSU1417400905
500	CSU14175000	CSU14175070	CSU1417500905
600	CSU14176000	CSU14176070	CSU1417600905

Console murale

En tôle d'acier
Également console murale 70 mm



● G.S

● RAL 9010

● RAL 9005

80610	80610IUP9010N	80610IUP9005N
-----------------------	-------------------------------	-------------------------------

Allonge pour console

S'adapte sur la console murale pour les différentes largeurs



● G.S

● RAL 9010

● RAL 9005

120	80602	80602IUP9010N	80602IUP9005N
200	80603	80603IUP9010N	80603IUP9005N
250	80604	80604IUP9010N	80604IUP9005N
330	80605	80605IUP9010N	80605IUP9005N
400	80606	80606IUP9010N	80606IUP9005N
500	80607	80607IUP9010N	80607IUP9005N

Pince



● G.S

● RAL 9010

● RAL 9005

[CSU08150209](#)

[CSU08150279](#)

[CSU0815029905](#)

Console 50i/50 renforcée

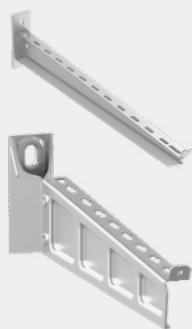

● G.S

● H.D.

● RAL 9005

	● G.S	● H.D.	● RAL 9005
100	791412	723432	CSU723432905
150	=	723433	CSU723433905
200	791413	723434	CSU723434905
250	=	723435	CSU723435905
300	791414	723436	CSU723436905
400	791415	723437	CSU723437905
500	795322	723438	CSU723438905
600	795323	723439	CSU723439905

Profilé de support



● G.S

● RAL 9010

● RAL 9005

	● G.S	● RAL 9010	● RAL 9005
120	CSU08041200	CSU08041270	CSU0804120905
200	CSU08043000	CSU08043070	CSU0804300905
250	CSU08044000	CSU08044070	CSU0804400905
330	CSU08045000	CSU08045070	CSU0804500905
400	CSU08046100	CSU08046170	CSU0804610905
500	CSU08047100	CSU08047170	CSU0804710905
600	CSU08048100	CSU08048170	CSU0804810905
800	CSU08047000	CSU08047070	CSU0804700905
1000	CSU08048000	CSU08048070	CSU0804800905

Index

80602	14	8143309	14	8605204UP9010N	8	30074002UP9010N	11	3022502UP9010N	12
80602IUP9005N	14	8161003	9	8605404	8	30075002	11	30223302	12
80602IUP9010N	14	8161003UP9005N	9	8605404UP9005N	8	30075002UP9005N	11	30223302UP9005N	12
80603	14	8161003UP9010N	9	8605404UP9010N	8	30075002UP9010N	11	30223302UP9010N	12
80603IUP9005N	14	8162003	9	8606204	8	30076002	11	30224002	12
80603IUP9010N	14	8162003UP9005N	9	8606204UP9005N	8	30076002UP9005N	11	30224002UP9005N	12
80604	14	8162003UP9010N	9	8606204UP9010N	8	30076002UP9010N	11	30224002UP9010N	12
80604IUP9005N	14	8163003	9	8750000	13	30150702	10	30225002	12
80604IUP9010N	14	8163003UP9005N	9	8750000IUP9005N	13	30150702UP9005N	10	30225002UP9005N	12
80605	14	8163003UP9010N	9	8750000IUP9010N	13	30150702UP9010N	10	30225002UP9010N	12
80605IUP9005N	14	8164003	9	8940000	9	30151202	10	30226002	12
80605IUP9010N	14	8164003UP9005N	9	8940000UP9005N	9	30151202UP9005N	10	30226002UP9005N	12
80606	14	8164003UP9010N	9	8940000UP9010N	9	30151202UP9010N	10	30226002UP9010N	12
80606IUP9005N	14	8165004	9	8960000	9	30152002	10	30230702	12
80606IUP9010N	14	8165004UP9005N	9	8960000UP9005N	9	30152002UP9005N	10	30230702UP9005N	12
80607	14	8165004UP9010N	9	8960000UP9010N	9	30152002UP9010N	10	30230702UP9010N	12
80607IUP9005N	14	8166004	9	30060702	9	30152502	10	30231202	12
80607IUP9010N	14	8166004UP9005N	9	30060702UP9005N	9	30152502UP9005N	10	30231202UP9005N	12
80610	14	8166004UP9010N	9	30060702UP9010N	9	30152502UP9010N	10	30231202UP9010N	12
80610IUP9005N	14	8167004	9	30061202	9	30153302	10	30232002	12
80610IUP9010N	14	8167004UP9005N	9	30061202UP9005N	9	30153302UP9005N	10	30232002UP9005N	12
86510	13	8167004UP9010N	9	30061202UP9010N	9	30153302UP9010N	10	30232002UP9010N	12
86510IUP9005N	13	8168004	9	30062002	9	30154002	10	30232502	12
86510IUP9010N	13	8168004UP9005N	9	30062002UP9005N	9	30154002UP9005N	10	30232502UP9005N	12
86520	13	8168004UP9010N	9	30062002UP9010N	9	30154002UP9010N	10	30232502UP9010N	12
86520IUP9005N	13	8250109	13	30062502	9	30155002	10	30233302	12
86520IUP9010N	13	8250109IUP9005N	13	30062502UP9005N	9	30155002UP9005N	10	30233302UP9005N	12
86530	13	8250109IUP9010N	13	30062502UP9010N	9	30155002UP9010N	10	30233302UP9010N	12
86530IUP9005N	13	8250209	13	30063302	9	30156002	10	30234002	12
86530IUP9010N	13	8250209UP9005N	13	30063302UP9005N	9	30156002UP9005N	10	30234002UP9005N	12
86540	13	8250209UP9010N	13	30063302UP9010N	9	30156002UP9010N	10	30234002UP9010N	12
86540IUP9005N	13	8601204	8	30064002	9	30160702	10	30235002	12
86540IUP9010N	13	8601204UP9005N	8	30064002UP9005N	9	30160702UP9005N	10	30235002UP9005N	12
88701	8	8601204UP9010N	8	30064002UP9010N	9	30160702UP9010N	10	30235002UP9010N	12
88705	8	8601404	8	30065002	9	30161202	10	30236002	12
723432	15	8601404UP9005N	8	30065002UP9005N	9	30161202UP9005N	10	30236002UP9005N	12
723433	15	8601404UP9010N	8	30065002UP9010N	9	30161202UP9010N	10	30236002UP9010N	12
723434	15	8602204	8	30066002	9	30162002	10	30252202	11
723435	15	8602204UP9005N	8	30066002UP9005N	9	30162002UP9005N	10	30252202UP9005N	11
723436	15	8602204UP9010N	8	30066002UP9010N	9	30162002UP9010N	10	30252202UP9010N	11
723437	15	8602404	8	30070702	11	30162502	10	30252402	11
723438	15	8602404UP9005N	8	30070702UP9005N	11	30162502UP9005N	10	30252402UP9005N	11
723439	15	8602404UP9010N	8	30070702UP9010N	11	30162502UP9010N	10	30252402UP9010N	11
791412	15	8603204	8	30071202	11	30163302	10	30252602	11
791413	15	8603204UP9005N	8	30071202UP9005N	11	30163302UP9005N	10	30252602UP9005N	11
791414	15	8603204UP9010N	8	30071202UP9010N	11	30163302UP9010N	10	30252602UP9010N	11
791415	15	8603404	8	30072002	11	30220702	12	30254702	11
795322	15	8603404UP9005N	8	30072002UP9005N	11	30220702UP9005N	12	30254702UP9005N	11
795323	15	8603404UP9010N	8	30072002UP9010N	11	30220702UP9010N	12	30254702UP9010N	11
8010109	8	8604204	8	30072502	11	30221202	12	30254802	11
8090109	13	8604204UP9005N	8	30072502UP9005N	11	30221202UP9005N	12	30254802UP9005N	11
8090109IUP9005N	13	8604204UP9010N	8	30072502UP9010N	11	30221202UP9010N	12	30254802UP9010N	11
8090109IUP9010N	13	8604404	8	30073302	11	30222002	12	30256402	11
8140709	14	8604404UP9005N	8	30073302UP9005N	11	30222002UP9005N	12	30256402UP9005N	11
8141209	14	8604404UP9010N	8	30073302UP9010N	11	30222002UP9010N	12	30256402UP9010N	11
8142009	14	8605204	8	30074002	11	30222502	12	36060702	9
8142509	14	8605204UP9005N	8	30074002UP9005N	11	30222502UP9005N	12	36060702UP9005N	9

36060702UP9010N	9	36152502UP9010N	10	36185004UP9010N	13	36252402UP9010N	11	CSU08044070	15
36061202	9	36153302	10	36186004	13	36252602	11	CSU08045000	15
36061202UP9005N	9	36153302UP9005N	10	36186004UP9005N	13	36252602UP9005N	11	CSU08045070	15
36061202UP9010N	9	36153302UP9010N	10	36186004UP9010N	13	36252602UP9010N	11	CSU08046100	15
36062002	9	36154002	10	362220702	12	36254702	11	CSU08046170	15
36062002UP9010N	9	36154002UP9005N	10	362220702UP9005N	12	36254702UP9005N	11	CSU08047000	15
36062002UP9055N	9	36154002UP9010N	10	362220702UP9010N	12	36254702UP9010N	11	CSU08047070	15
36062502	9	36155002	10	36221202	12	36254802	11	CSU08047100	15
36062502UP9005N	9	36155002UP9005N	10	36221202UP9005N	12	36254802UP9005N	11	CSU08047170	15
36062502UP9010N	9	36155002UP9010N	10	36221202UP9010N	12	36254802UP9010N	11	CSU08048000	15
36063302	9	36156002	10	36222002	12	36256402	11	CSU08048070	15
36063302UP9005N	9	36156002UP9005N	10	36222002UP9005N	12	36256402UP9005N	11	CSU08048100	15
36063302UP9010N	9	36156002UP9010N	10	36222002UP9010N	12	36256402UP9010N	11	CSU08048170	15
36064002	9	36160702	10	36222502	12	36510702	10	CSU08150209	15
36064002UP9005N	9	36160702UP9005N	10	36222502UP9005N	12	36510702UP9005N	10	CSU08150279	15
36064002UP9010N	9	36160702UP9010N	10	36222502UP9010N	12	36510702UP9010N	10	CSU08171279	14
36065002	9	36161202	10	36223302	12	36511202	10	CSU08172279	14
36065002UP9005N	9	36161202UP9005N	10	36223302UP9005N	12	36511202UP9005N	10	CSU08173279	14
36065002UP9010N	9	36161202UP9010N	10	36223302UP9010N	12	36511202UP9010N	10	CSU08174279	14
36066002	9	36162002	10	36224002	12	36512002	10	CSU08175279	14
36066002UP9005N	9	36162002UP9010N	10	36224002UP9005N	12	36512002UP9005N	10	CSU08176279	14
36066002UP9010N	9	36162002UP9055N	10	36224002UP9010N	12	36512002UP9010N	10	CSU14174000	14
36070702	11	36162502	10	36225002	12	36512502	10	CSU14174070	14
36070702UP9005N	11	36162502UP9005N	10	36225002UP9005N	12	36512502UP9005N	10	CSU14175000	14
36070702UP9010N	11	36162502UP9010N	10	36225002UP9010N	12	36512502UP9010N	10	CSU14175070	14
36071202	11	36163302	10	36226002	12	36520702	9	CSU14176000	14
36071202UP9005N	11	36163302UP9005N	10	36226002UP9005N	12	36520702IUP9005N	9	CSU14176070	14
36071202UP9010N	11	36163302UP9010N	10	36226002UP9010N	12	36520702IUP9010N	9	CSU14450100	13
36072002	11	36164002	10	36230702	12	36521202	9	CSU14450170	13
36072002UP9005N	11	36164002UP9005N	10	36230702UP9005N	12	36521202IUP9005N	9	CSU723432905	15
36072002UP9010N	11	36164002UP9010N	10	36230702UP9010N	12	36521202IUP9010N	9	CSU723433905	15
36072502	11	36165002	10	36231202	12	36522002	9	CSU723434905	15
36072502UP9005N	11	36165002UP9005N	10	36231202UP9005N	12	36522002IUP9005N	9	CSU723435905	15
36072502UP9010N	11	36165002UP9010N	10	36231202UP9010N	12	36522002IUP9010N	9	CSU723436905	15
36073302	11	36166002	10	36232002	12	36522502	9	CSU723437905	15
36073302UP9005N	11	36166002UP9005N	10	36232002UP9005N	12	36522502IUP9005N	9	CSU723438905	15
36073302UP9010N	11	36166002UP9010N	10	36232002UP9010N	12	36522502IUP9010N	9	CSU723439905	15
36074002	11	36180704	13	36232502	12	76014004	8	CSU0804120905	15
36074002UP9005N	11	36180704UP9005N	13	36232502UP9005N	12	76014004UP9005N	8	CSU0804300905	15
36074002UP9010N	11	36180704UP9010N	13	36232502UP9010N	12	76014004UP9010N	8	CSU0804400905	15
36075002	11	36181204	13	36233302	12	76015004	8	CSU0804500905	15
36075002UP9005N	11	36181204UP9005N	13	36233302UP9005N	12	76015004UP9005N	8	CSU0804610905	15
36075002UP9010N	11	36181204UP9010N	13	36233302UP9010N	12	76015004UP9010N	8	CSU0804700905	15
36076002	11	36182004	13	36234002	12	76016004	8	CSU0804710905	15
36076002UP9005N	11	36182004UP9005N	13	36234002UP9005N	12	76016004UP9005N	8	CSU0804800905	15
36076002UP9010N	11	36182004UP9010N	13	36234002UP9010N	12	76016004UP9010N	8	CSU0804810905	15
36150702	10	36182504	13	36235002	12	CEZ070	14	CSU0815029905	15
36150702UP9005N	10	36182504UP9005N	13	36235002UP9005N	12	CEZ120	14	CSU0817129905	14
36150702UP9010N	10	36182504UP9010N	13	36235002UP9010N	12	CEZ200	14	CSU0817229905	14
36151202	10	36183304	13	36236002	12	CEZ250	14	CSU0817329905	14
36151202UP9005N	10	36183304UP9005N	13	36236002UP9005N	12	CEZ330	14	CSU0817429905	14
36151202UP9010N	10	36183304UP9010N	13	36236002UP9010N	12	CEZ400	14	CSU0817529905	14
36152002	10	36184004	13	36252202	11	CSU08041200	15	CSU0817629905	14
36152002UP9010N	10	36184004UP9005N	13	36252202UP9005N	11	CSU08041270	15	CSU1417400905	14
36152002UP9055N	10	36184004UP9010N	13	36252202UP9010N	11	CSU08043000	15	CSU1417500905	14
36152502	10	36185004	13	36252402	11	CSU08043070	15	CSU1417600905	14
36152502UP9005N	10	36185004UP9005N	13	36252402UP9005N	11	CSU08044000	15	CSU1445010905	13



Notre **catalogue en ligne** vous donne un accès instantané à plus de **20 000 produits** avec les spécifications techniques nécessaires, les manuels d'assemblage, les vidéos disponibles, etc.

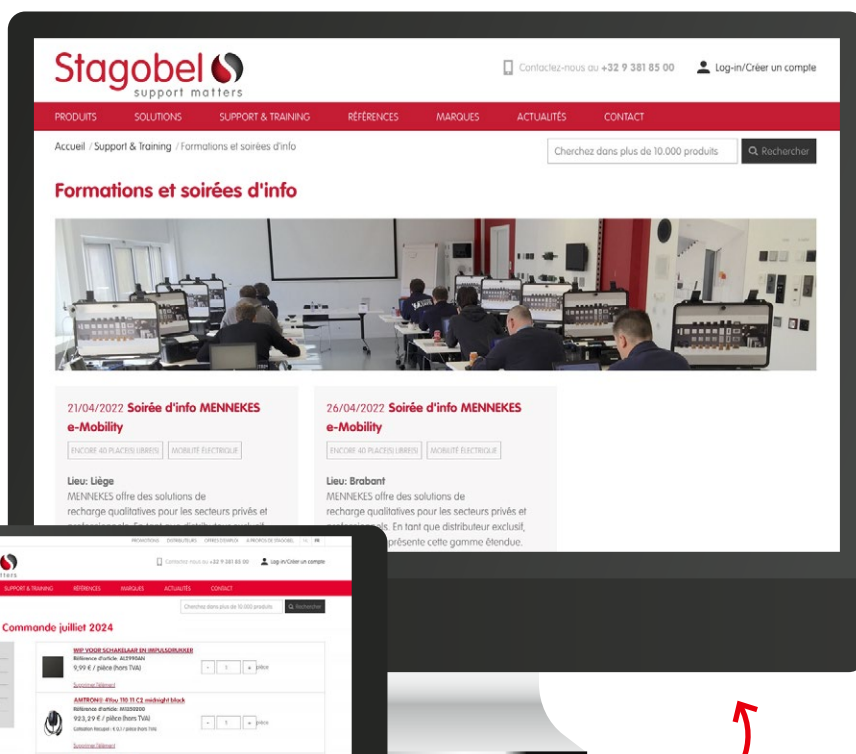
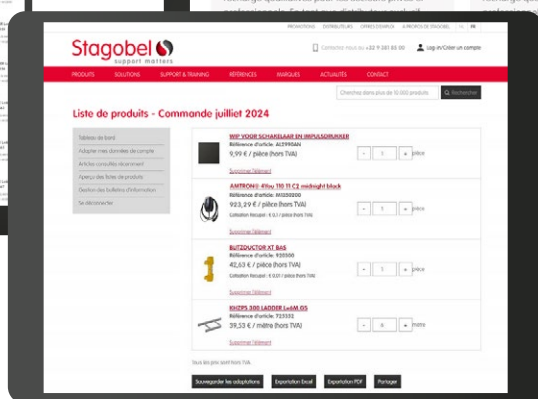

Dans votre **compte personnel MyStagobel**, vous trouvez vos produits préférés, les prix bruts, notre stock de produits, etc. Vous pouvez également rédiger des listes de matériaux et, le cas échéant, les envoyer à un collègue, votre personne de contact chez un grossiste...

Sur le **campus Stagobel**, vous trouvez toutes les informations sur les formations et workshops prévus, tant dans nos bureaux à Waremme et Deinze qu'à des endroits externes. Nous organisons également des webinars. Un enregistrement en ligne est possible.

Nous vous fournissons toutes les informations techniques, les mises à jour, les logiciels, ... 24h/24 et 7j/7

Dans la **bibliothèque Stagobel**, vous pouvez soit télécharger les documents souhaités, soit en demander une copie imprimée. Si vous envoyez cette demande via votre compte MyStagobel, toutes les informations nécessaires seront automatiquement remplies pour vous.

Dans notre **aperçu déroulant de solutions**, vous trouvez la solution appropriée pour chaque question ou application spécifique. Découvrez vite notre portfolio étendu de solutions intégrées, fondées sur nos gammes de produits qualitatives, efficaces et économiques.

Nos marques



CABLE MANAGEMENT | HOME AUTOMATION | ELECTRICAL SAFETY | E-MOBILITY | POWER CONNECTION

Stagobel est l'importateur exclusif de matériel électrique pour l'électro-installateur et l'industrie. Le vaste programme de produits de haute qualité comprend des systèmes de support de câbles économiques pour bâtiments industriels et tertiaires, le matériel de contact CEE, l'équipement pour la sécurité dans les installations électriques, des stations de recharge pour e-Mobility, des solutions innovatrices pour la gestion des bâtiments et la domotique.

Suivez-nous sur



Stagobel



Stagobel



Stagobel



Stagobel