

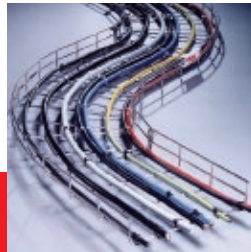

Liste des prix systèmes de support de câbles

Mars 2020

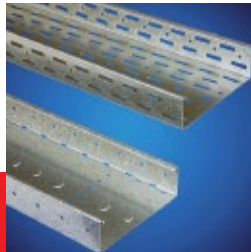

A propos de nous

Depuis 1977, Stagobel Electro est l'importateur exclusif pour le marché belge des matériaux d'installation électriques de fabricants renommés, belges et internationaux. Nous fournissons des produits et services, qui permettent à nos clients de consolider la sécurité, la fiabilité, la flexibilité, la durabilité et le confort des installations électriques dans l'industrie, les bureaux et les habitations.

Notre portfolio de produits se concentre sur cinq domaines: les systèmes de support de câbles pour l'industrie et les bureaux, le matériel de contact industriel CEE, la gestion des bâtiments, la protection contre la foudre et les surtensions et les stations de recharge pour l'e-mobility.

QUALITÉ

Nos partenaires-fabricants prônent des valeurs telles que l'innovation, la qualité, le design et la sécurité. Ils méritent toute votre confiance. Leurs produits, soigneusement conçus, répondent aux exigences du client. Nos fabricants innovent et investissent dans l'avenir afin de vous offrir le meilleur appui possible.

SUPPORT MATTERS!

Au fil des ans, la connaissance spécialisée de nos produits a été soigneusement édifée au sein de notre équipe de spécialistes bien formés et expérimentés. Nous aimons réfléchir avec vous. Vous pouvez compter sur notre support pour tout conseil durant la phase de conception, d'exécution ou de mise en service de votre projet. Rapide et professionnel. En ce qui concerne notre département de gestion des bâtiments, vous pouvez en outre compter sur un service professionnel après-vente.

COMPÉTENCE

Nous aimons partager notre connaissance et expérience. Suivez nos workshops, formations, séminaires, tous fréquemment organisés et bien fréquentés, et restez ainsi au courant de tous les nouveaux développements et tendances. Ainsi, vous pouvez conseiller vos clients en toute connaissance de cause.

PARTENARIAT

En tant que PME familiale, nous sommes persuadés que nos clients forment la base de notre entreprise. Un partenariat solide avec nos clients et nos fabricants constitue le fondement de notre organisation pour l'avenir. Que ce soit pour une question technique simple, une offre, une livraison ou la réception de travaux ... l'on peut toujours compter sur Stagobel Electro. Grâce à une étroite collaboration avec le réseau des électro-grossistes professionnels, nos produits sont aisément et rapidement disponibles dans toute la Belgique. Nous promettons uniquement ce que nous pouvons réaliser et nous considérons nos accords comme impératifs et contraignants.



Stock étendu, délai de livraison court.



Notre showroom.



Notre équipe technique pour un soutien rapide et professionnel.



Notre connaissance reste à jour, grâce à nos formations.



Le site internet Stagobel STAGOBEL.BE

Un trésor
d'informations

Notre **catalogue en ligne** vous donne un accès instantané à plus de **10 000 produits** avec les spécifications techniques nécessaires, les manuels d'assemblage, les vidéos disponibles, etc.

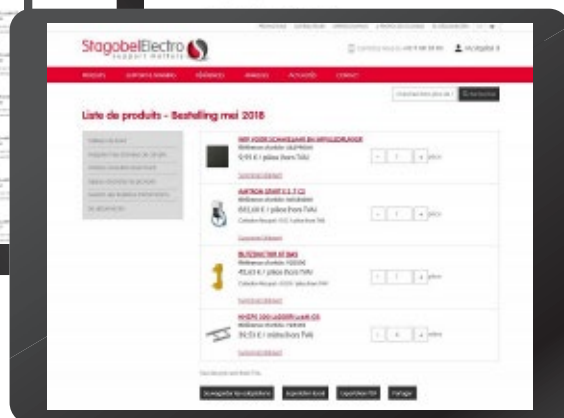
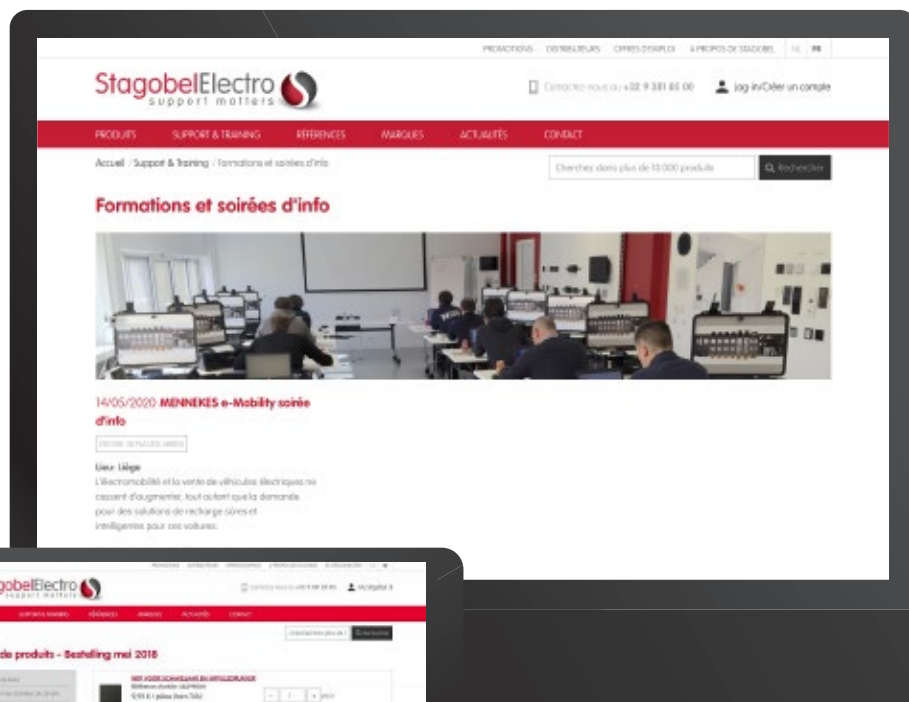
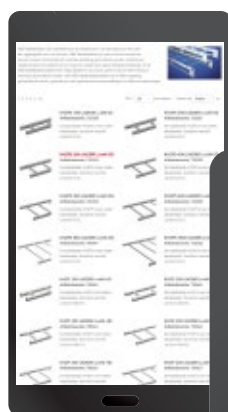

Dans votre **compte personnel MyStagobel**, vous trouverez vos produits préférés, les prix bruts, notre stock de produits, etc. Vous pouvez également rédiger des listes de matériaux et, le cas échéant, les envoyer à un collègue, votre personne de contact chez un grossiste...

Sur le **campus Stagobel**, vous trouverez toutes les informations sur les formations et workshops prévus, tant dans nos bureaux à Deinze qu'à des endroits externes. Un enregistrement en ligne est également possible.

Nous vous fournissons toutes les informations techniques, les mises à jour, les logiciels, ... 24h/24 et 7j/7

Dans la **bibliothèque Stagobel**, vous pouvez soit télécharger les documents souhaités, soit en demander une copie imprimée. Si vous envoyez cette demande via votre compte MyStagobel, toutes les informations nécessaires seront automatiquement remplies pour vous.

Dans notre **aperçu déroulant de solutions**, vous trouvez la solution appropriée pour chaque question ou application spécifique. Découvrez vite notre portfolio étendu de solutions intégrées, fondées sur nos gammes de produits qualitatives, efficaces et économiques.

Légende

Général		Caractéristiques	
	Tous les prix bruts sont en euro, hors TVA. Les prix des articles vendus par longueurs s'entendent au mètre. Les prix des accessoires s'entendent par pièce, par set ou par boîte.		Info supplémentaire
	Nouveau dans l'assortiment.		Largeur (mm)
	Cet article est uniquement livré en emballage standard.		Hauteur (mm)
	Cette longueur est uniquement livrée en longueur standard.		Longueur (mm)
	Pour faciliter le transport, il est recommandé de commander cet article dans la quantité indiquée.		Charge légère
	✓ signifie disponible de stock. Pour l'état de stock actuel, veuillez bien consulter notre site Web. Si temporairement pas en stock, nous vous garantissons un délai de livraison rapide.		Charge moyenne
			Charge élevée
			Maintien de fonction E60/E90

Applications	
	Industrie
	Tertiaire
	Tunnels
	Centres de données
	Installations PV
	Industrie alimentaire
	Pétrochimie

Traitement de surface		
Traitement de surface		Recommandé dans les environnements corrosifs mentionnés ci-après selon NBN- EN ISO 12944-2
E.Z.	Zingage électrolytique NBN EN ISO 2081	C1 (très faible)
G.S.	Galvanisation Sendzimir NBN EN 10346	C2 (faible)
Z.B.	Zingage électrolytique, bichromaté NBN EN ISO 2081	C2 (faible)
H.D.	Galvanisation à chaud NBN EN ISO 1461	C3/C4 (moyen/haut)
Black C8	Black C8, Protection Haute Résistance, Class 8 IEC 61537	C5-I (très élevé – industrie)
Zinkpox blanc	Galvanisation à chaud + epoxy coating	C5-I (très élevé – industrie)
INOX 304	Acier inoxydable AISI 304	C5-I (très élevé – industrie)
INOX 316L	Acier inoxydable AISI 316L	C5-M (très élevé – maritime)

Les environnements corrosifs selon NBN EN ISO 12944-2

	C1	Bâtiments chauffés à faible exposition à la corrosion, comme p. ex. les hôtels et les bureaux.
	C2	Bâtiments non chauffés dans des atmosphères à faible taux de pollution (généralement dans des zones rurales), comme p.ex. les entrepôts et les parkings souterrains.
	C3	Villes et environnements de l'industrie légère à corrosion environnementale moyenne, comme p.ex. les blanchisseries, les brasseries et l'industrie alimentaire.
	C4	Environnements industriels et zones côtières à taux de salinité moyen et présentant un taux élevé de corrosion environnementale, d'humidité de l'air et de pollution de l'air, comme p.ex. les entreprises chimiques, les zones portuaires et les piscines.
	C5-I	Environnements présentant un taux élevé d'humidité de l'air et de pollution de l'air presque constant, comme p.ex. les industries chimiques et lourdes, les tunnels et les zones portuaires.
	C5-M	Environnements présentant un taux élevé d'humidité de l'air, de pollution de l'air et de salinité presque constant, comme p.ex. les zones côtières et offshore.

Contenu

	page
Echelles à câbles WIBE	4
Gaines à câbles et chemins de câbles STAGO	36
Chemins de câbles et gaines à câbles PEMSA	57
Systèmes de support de câbles en matière composite MITA	83
Treillis à câbles PEMSA	85
Système de suspension avec câble SPIDERBAND	115
Profilés STAGOBEL et accessoires	119
Systèmes de support de câbles avec maintien de fonction	127
Systèmes de gaines de sol PUK	141
Gaines murales en aluminium et en matière synthétique DUCTEL	179
Canalisations à câbles en matière synthétique KOPOS	195
Colonnes de distribution et de bureau en aluminium IDT	223
Connexions bureautiques IBCONNECT	229
Index	248
Conditions de vente générales	264







Échelles à câbles









La colonne vertébrale d'une structure exceptionnelle

Les systèmes de support de câbles sont essentiels à l'infrastructure d'un bâtiment, de la même manière que l'est la colonne vertébrale pour notre corps. Les échelles à câbles WIBE sont solides et fonctionnelles et peuvent être montées à l'horizontale ou à la verticale. Fort d'une vaste gamme d'accessoires et d'une grande variété de traitements de surface, le système d'échelles à câbles WIBE constitue une gamme sûre, flexible et facile d'entretien, pouvant être montée dans toutes les directions et dans tous les angles.











Aperçu

KHZSP KHZSPZ	KHZPS KHZP	KHZ	KHZPV	KHZV
Profilé ouvert échelon perforé	Profilé fermé échelon perforé	Profilé fermé échelon rond	Profilé fermé renforcé échelon perforé	Profilé fermé renforcé échelon rond
				

Caractéristiques

G.S.	✓	✓			
H.D.	✓	✓	✓	✓	✓
ZINKPOX blanc		✓	✓	✓	✓
INOX 316L		✓	✓	✓	
 mm	200-600	150-1000	150-600	200-1000	200-600
 mm	55	55	55	150	150
L mm	3000-4000-6000	6000	6000	6000	6000
 N/m					
		E60			

Applications

 Industrie		✓	✓	✓	✓
 Tertiaire	✓				
 Tunnels	✓	✓	✓	✓	✓
 Centres de données	✓	✓	✓		
 Installations PV	✓	✓	✓		
 Industrie alimentaire			✓		✓
 Pétrochimie/pharma		✓	✓	✓	✓
 G.S.	page 6	page 6	-	-	-
 H.D.	page 6	page 6	page 7	page 7	page 7
 Zinkpox blanc	-	page 6	page 7	page 7	page 7
 INOX 316L	-	page 6	page 7	page 7	-

G.S.

Galvanisé Sendzimir NBN EN10346 – recommandé dans les environnements corrosifs C2 (faible)

H.D.

Galvanisé à chaud NBN EN ISO 1461 – recommandé dans les environnements corrosifs C3/C4 (moyen/haut)

Zinkpox blanc

Galvanisé à chaud + epoxy coating – recommandé dans les environnements corrosifs C5-I (très élevé/industrie)

INOX 316L

Acier inoxydable AISI316L – recommandé dans les environnements corrosifs C5-M (très élevé/maritime)

 voir page 2

Echelles à câbles

	type	référence	stock	page. catal.	groupe d'articles	prix en €	
	Echelle à câbles KHZSP						
	Acier galvanisé Sendzimir	200	783155	✓	21	1303	20,90/m
	↔ 3 m	300	783156	✓	21	1303	25,75/m
		400	783157	✓	21	1303	29,29/m
		500	783158	✓	21	1303	34,08/m
		600	783159	✓	21	1303	37,57/m
Echelle à câbles KHZSP							
Acier galvanisé Sendzimir	200	718572	✓	21	1303	20,90/m	
↔ 4 m	300	718573	✓	21	1303	25,75/m	
	400	718574	✓	21	1303	29,29/m	
	500	718575		21	1303	34,08/m	
	600	718576		21	1303	37,57/m	
	Echelle à câbles KHZSP						
Acier galvanisé Sendzimir	200	734488	✓	21	1303	20,90/m	
↔ 6 m	300	734489	✓	21	1303	25,75/m	
	400	734490	✓	21	1303	29,29/m	
	500	734491		21	1303	34,08/m	
	600	734492		21	1303	37,57/m	
		Echelle à câbles KHZSPZ					
Acier galvanisé à chaud		200	734494	✓	22	1301	38,93/m
↔ 6 m		300	734495	✓	22	1301	40,67/m
		400	734496	✓	22	1301	43,54/m
		500	734497		22	1301	47,26/m
		600	734498	✓	22	1301	49,88/m
	Echelle à câbles KHZPS						
Acier galvanisé Sendzimir	150	725350	✓	23	1308	40,75/m	
↔ 6 m	200	725351	✓	23	1308	40,75/m	
	300	725352	✓	23	1308	42,14/m	
	400	725353	✓	23	1308	43,90/m	
	500	725354	✓	23	1308	46,20/m	
	600	725355	✓	23	1308	48,63/m	
	800	781099		23	1308	74,27/m	
	1000	725356		23	1308	114,39/m	
	Echelle à câbles KHZP						
Acier galvanisé à chaud	150	718562	✓	25	1312	47,12/m	
↔ 6 m	200	718563	✓	25	1312	47,12/m	
	300	718564	✓	25	1312	49,11/m	
	400	718565	✓	25	1312	51,28/m	
	500	718566	✓	25	1312	55,06/m	
	600	718567	✓	25	1312	57,34/m	
	800	721960	✓	25	1312	104,60/m	
	1000	718568	✓	25	1312	175,15/m	
	Echelle à câbles KHZP						
Zinkpox blanc	150	718591		25	1302	75,38/m	
↔ 6 m	200	718592		25	1302	75,38/m	
	300	718593		25	1302	78,60/m	
	400	718594		25	1302	82,06/m	
	500	718595		25	1302	88,12/m	
	600	718596		25	1302	92,07/m	
	800	728033		25	1302	167,35/m	
	1000	718597		25	1302	280,22/m	

Echelles à câbles

	type	référence	stock	page. catal.	groupe d'articles	prix en €	
	Echelle à câbles KHZP						
	Acier inoxydable AISI 316L	150	727382	✓	25	1305	202,67/m
	↔ 6 m	200	727383	✓	25	1305	205,50/m
		300	727384	✓	25	1305	211,17/m
		400	727385	✓	25	1305	222,49/m
		500	727386	✓	25	1305	231,93/m
		600	727387	✓	25	1305	243,26/m
800		782128	✓	25	1305	482,07/m	
1000	782129	✓	25	1305	553,08/m		
	Echelle à câbles KHZ						
	Acier galvanisé à chaud	150	768001	✓	24	1301	58,40/m
	↔ 6 m	200	768002	✓	24	1301	58,40/m
		300	768004	✓	24	1301	60,64/m
		400	768005	✓	24	1301	63,44/m
		500	768006	✓	24	1301	68,09/m
600		768007	✓	24	1301	71,04/m	
	Echelle à câbles KHZ						
	Zinkpox blanc	150	714058	✓	24	1302	93,46/m
	↔ 6 m	200	714059	✓	24	1302	93,46/m
		300	714061	✓	24	1302	97,02/m
		400	714062	✓	24	1302	101,52/m
		500	714063	✓	24	1302	108,94/m
600		714064	✓	24	1302	113,67/m	
	Echelle à câbles KHZ						
	Acier inoxydable AISI 316L	150	727376	✓	24	1305	335,52/m
	↔ 6 m	200	727377	✓	24	1305	340,69/m
		300	727378	✓	24	1305	356,69/m
		400	727379	✓	24	1305	360,33/m
		500	727380	✓	24	1305	367,37/m
600		727381	✓	24	1305	374,46/m	
	Echelle à câbles KHZV						
	Acier galvanisé à chaud	200	712015	✓	26	1301	113,17/m
	↔ 6 m	300	712017	✓	26	1301	116,15/m
		400	712019	✓	26	1301	118,67/m
		500	712018	✓	26	1301	123,05/m
		600	712020	✓	26	1301	124,45/m
		Echelle à câbles KHZV					
	Zinkpox blanc	200	714198	✓	26	1302	207,93/m
	↔ 6 m	300	714200	✓	26	1302	212,68/m
		400	714202	✓	26	1302	217,43/m
		500	714201	✓	26	1302	226,62/m
		600	714203	✓	26	1302	227,96/m
		Echelle à câbles KHZPV					
	Acier galvanisé à chaud	200	717982	✓	27	1301	113,17/m
	↔ 6 m	300	717983	✓	27	1301	116,15/m
		400	717984	✓	27	1301	118,67/m
		500	717985	✓	27	1301	123,05/m
		600	717986	✓	27	1301	124,45/m
1000		716400	✓	27	1301	292,28/m	
	Echelle à câbles KHZPV						
	Zinkpox blanc	200	723390	✓	27	1302	193,21/m
	↔ 6 m	300	723391	✓	27	1302	197,73/m
		400	723392	✓	27	1302	201,62/m
		500	723393	✓	27	1302	209,72/m
		600	723394	✓	27	1302	210,16/m
1000		716401	✓	27	1302	390,96/m	



Echelles à câbles

	type	référence	stock	page. catal.	groupe d'articles	prix en €	
	Echelle à câbles KHZPV						
	Acier inoxydable AISI 316L	200	784066		27	1305	432,86/m
	↔ 6 m	300	784067		27	1305	450,66/m
		400	784068		27	1305	474,88/m
		500	784069		27	1305	493,83/m
		600	784070		27	1305	509,37/m
	1000	784072		27	1305	934,97/m	
	Console 50i						
	Acier galvanisé Sendzimir	50i/ 100	791412	✓	30	1304	4,38/pc.
		50i/ 200	791413	✓	30	1304	6,10/pc.
		50i/ 300	791414	✓	30	1304	7,41/pc.
		50i/ 400	791415	✓	30	1304	11,99/pc.
		50i/ 500	795322	✓		1304	18,65/pc.
	50i/ 600	795323	✓		1304	21,18/pc.	
	Console 50i						
	Acier galvanisé à chaud	50i/ 100	795316	✓		1304	7,95/pc.
		50i/ 200	795317	✓		1304	8,98/pc.
		50i/ 300	795318	✓		1304	13,15/pc.
		50i/ 400	795319	✓		1304	14,93/pc.
		50i/ 500	795320	✓		1304	20,34/pc.
	50i/ 600	795321	✓		1304	22,96/pc.	
	Console 30						
	Acier galvanisé Sendzimir	30/ 200	727777		31	1313	38,89/pc.
		30/ 300	727778		31	1313	42,47/pc.
	Seulement pour échelles à câbles KHZSP.	30/ 400	727779		31	1313	47,36/pc.
		30/ 500	727780		31	1313	52,58/pc.
	30/ 600	727781		31	1313	54,06/pc.	
	Console 50						
	Acier galvanisé à chaud	50/ 100	723432	✓	32	1304	14,02/pc.
		50/ 150	723433	✓	32	1304	14,18/pc.
		50/ 200	723434	✓	32	1304	14,54/pc.
		50/ 250	723435	✓	32	1304	16,43/pc.
		50/ 300	723436	✓	32	1304	16,74/pc.
		50/ 400	723437	✓	32	1304	26,46/pc.
		50/ 500	723438	✓	32	1304	34,99/pc.
		50/ 600	723439	✓	32	1304	36,74/pc.
		50/ 700	727125	✓	32	1304	71,70/pc.
		50/ 800	727126	✓	32	1304	75,56/pc.
		50/ 900	727127	✓	32	1304	83,26/pc.
		50/ 1000	727128	✓	32	1304	89,29/pc.
	Console 50						
	Zinkpox blanc	50/ 100	723440		32	1302	43,48/pc.
		50/ 150	723441		32	1302	43,48/pc.
		50/ 200	723442		32	1302	44,20/pc.
		50/ 250	723443		32	1302	51,88/pc.
		50/ 300	723444		32	1302	53,36/pc.
		50/ 400	723445		32	1302	70,31/pc.
		50/ 500	723446		32	1302	90,96/pc.
		50/ 600	723447		32	1302	94,94/pc.
		50/ 700	727782		32	1302	147,59/pc.
		50/ 800	727783		32	1302	167,10/pc.
	50/ 900	727784		32	1302	170,99/pc.	
	50/ 1000	727785		32	1302	172,80/pc.	

Echelles à câbles

	type	référence	stock	page. catal.	groupe d'articles	prix en €	
	Console 50						
	Acier inoxydable AISI 316L	50/ 100	725618		32	1305	93,42/pc.
		50/ 150	725619	✓	32	1305	94,86/pc.
		50/ 200	725620	✓	32	1305	97,80/pc.
		50/ 250	725621	✓	32	1305	113,98/pc.
		50/ 300	725622	✓	32	1305	194,43/pc.
		50/ 400	725623	✓	32	1305	244,16/pc.
		50/ 500	725624	✓	32	1305	265,21/pc.
	50/ 600	725625	✓	32	1305	290,79/pc.	
	Console 50F						
	Acier galvanisé à chaud	50F/ 200	718624	✓	32	1313	50,84/pc.
		50F/ 300	718625	✓	32	1313	55,04/pc.
		50F/ 400	718626	✓	32	1313	63,25/pc.
		50F/ 500	718627	✓	32	1313	71,63/pc.
		50F/ 600	718628	✓	32	1313	79,94/pc.
		50F/ 1000	712465	✓	32	1313	207,53/pc.
	Console 50F						
	Zinkpox blanc	50F/ 200	714021		32	1302	63,05/pc.
		50F/ 300	714700		32	1302	71,10/pc.
		50F/ 400	714022		32	1302	80,43/pc.
		50F/ 500	718793		32	1302	97,86/pc.
		50F/ 600	714023		32	1302	104,52/pc.
	50F/ 1000	714024		32	1302	240,80/pc.	
   	Etrier 42						
	Acier galvanisé Sendzimir	42	795240	✓		1313	4,00/pc.
	 10 pc.						
	Etrier 42						
	Zinc+	42	795241	✓		1313	5,55/pc.
	Acier galvanisé à chaud	42	795242	✓		1313	6,33/pc.
	 10 pc.						
	Etrier 42						
	Zinkpox blanc	42	795243	✓		1302	14,13/pc.
	 10 pc.						
Etrier 42							
Acier inoxydable AISI 316L	42	725763	✓	34	1305	10,67/pc.	
 10 pc.							







Echelles à câbles

	type	référence	📦 stock	page. catal.	groupe d'articles	prix en €	
	Etrier 43						
	Acier galvanisé à chaud	43	707511	✓	34	1313	9,70/pc.
	 10 pc.						
	Etrier 43						
	Zinkpox blanc	43	714165		34	1302	12,55/pc.
	 10 pc.						
	Etrier 43						
	Acier inoxydable AISI 316L	43	792893	✓		1305	15,42/pc.
	 10 pc.						
	Plaque de fond 40						
	Acier galvanisé à chaud	40	768738		35	1313	18,76/pc.
	Plaque de fond 40						
	Zinkpox blanc	40	714029		35	1302	28,16/pc.
	Profilé de suspension 40						
	Acier galvanisé à chaud L = 270 mm	40	717001		35	1313	24,63/pc.
	Profilé de suspension 40						
	Zinkpox wit L = 270 mm	40	729045		35	1302	65,30/pc.
	Fixation tige/ console 82						
Acier galvanisé à chaud	82	786768		36	1313	66,93/pc.	



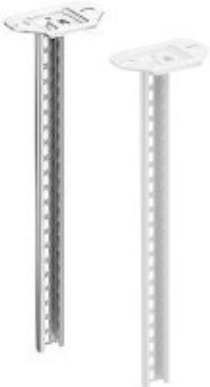
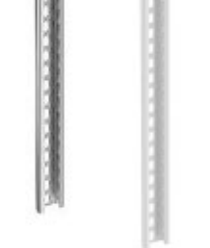



Echelles à câbles

	type	référence	stock	page. catal.	groupe d'articles	prix en €	
	Support console 3						
	Acier galvanisé Sendzimir	3/ 200	721869	38	1313	13,05/pc.	
		3/ 300	721870	38	1313	17,79/pc.	
		3/ 400	721871	38	1313	19,06/pc.	
		3/ 500	721872	38	1313	25,27/pc.	
	3/ 600	721873	38	1313	27,66/pc.		
	Support console 3						
	Acier galvanisé à chaud	3/ 150	720761	38	1313	17,49/pc.	
		3/ 200	720762	38	1313	18,25/pc.	
		3/ 300	720763	38	1313	19,98/pc.	
		3/ 400	720764	38	1313	23,09/pc.	
	3/ 500	720765	38	1313	30,81/pc.		
	3/ 600	720766	38	1313	35,51/pc.		
	Support console 3						
	Zinkpox blanc	3/ 150	721862	38	1302	43,90/pc.	
		3/ 200	721863	38	1302	44,39/pc.	
		3/ 300	721864	38	1302	50,16/pc.	
		3/ 400	721865	38	1302	51,95/pc.	
	3/ 500	721866	38	1302	57,33/pc.		
	3/ 600	721867	38	1302	59,95/pc.		
	Support console 3						
	Acier inoxydable AISI 316L	3/ 150	726433	38	1305	96,89/pc.	
		3/ 200	726434	38	1305	99,50/pc.	
		3/ 300	726435	38	1305	148,62/pc.	
		3/ 400	726436	38	1305	201,76/pc.	
	3/ 500	726437	38	1305	314,17/pc.		
	3/ 600	726438	38	1305	339,91/pc.		
	Support console HSO						
	Acier galvanisé à chaud	150/M10	791063	✓	40	1313	20,21/pc.
		200/M10	791064	✓	40	1313	20,66/pc.
		300/M10	791065	✓	40	1313	21,10/pc.
		400/M16	791066		40	1313	21,79/pc.
		500/M16	791067		40	1313	22,61/pc.
	600/M16	791068		40	1313	23,03/pc.	
	Plaque de fond HSO M16						
Acier galvanisé à chaud	M16	791092		40	1313	3,99/pc.	
📦 10 pc.							
	Support console 6						
	Acier galvanisé Sendzimir	6/ 200	727582		41	1313	14,34/pc.
		6/ 300	727583		41	1313	16,63/pc.
	Seulement pour échelles à câbles KHZSP.	6/ 400	727584		41	1313	19,65/pc.
		6/ 500	727585		41	1313	24,57/pc.
	6/ 600	727586		41	1313	27,68/pc.	
	Tige filetée M10						
	Acier à zingage électrolytique	2000	716792	✓	42	1313	4,80/m
	↔ 2 m ↔ 3 m	3000	716793	✓	42	1313	4,80/m
	Tige filetée M10						
	Acier inoxydable AISI 316	2000	723925		42	1305	69,80/m
	↔ 2 m ↔ 3 m	3000	723926		42	1305	75,41/m

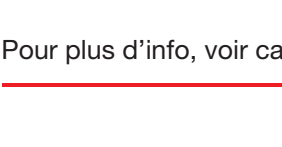

Echelles à câbles

	type	référence	📦 stock	page. catal.	groupe d'articles	prix en €	
	Ecrou de rallonge hexagonal						
	Acier à zingage électrolytique	M10	724806	✓	42	1313	4,98/pc.
	Acier inoxydable AISI 316	M10	724807		42	1305	38,90/pc.
	📦 10 pc.						
	Ecrou hexagonal						
	Acier galvanisé à chaud	M10	723938		42	1313	0,62/pc.
	Acier inoxydable AISI 316	M10	723939		42	1305	2,55/pc.
	📦 100 pc.						
	Pendard simple 2						
	Acier galvanisé à chaud	2/ 300	717191	✓	44	1313	15,95/pc.
		2/ 400	717192	✓	44	1313	17,84/pc.
		2/ 500	717193	✓	44	1313	18,75/pc.
		2/ 700	717194	✓	44	1313	26,20/pc.
		2/ 1000	717195	✓	44	1313	30,81/pc.
	Pendard simple 2						
	Zinkpox blanc	2/ 300	716283		44	1302	63,42/pc.
		2/ 400	716284		44	1302	66,55/pc.
		2/ 500	716285		44	1302	72,58/pc.
		2/ 700	716286		44	1302	79,15/pc.
		2/ 1000	716287		44	1302	90,96/pc.
	Pendard simple 2						
	Acier inoxydable AISI 316L	2/ 300	725557		44	1305	69,52/pc.
		2/ 400	725558		44	1305	77,12/pc.
		2/ 500	725559		44	1305	100,86/pc.
		2/ 700	725560		44	1305	108,09/pc.
		2/ 1000	725561		44	1305	131,80/pc.
	Pendard simple 2F						
	Acier galvanisé à chaud	2F/ 280	717196	✓	46	1313	22,18/pc.
		2F/ 370	717197	✓	46	1313	25,34/pc.
		2F/ 505	717198	✓	46	1313	28,77/pc.
		2F/ 640	794202			1313	29,79/pc.
		2F/ 730	717199	✓	46	1313	33,02/pc.
		2F/ 1000	717200	✓	46	1313	37,93/pc.
		2F/ 1500	787276	✓	46	1313	110,14/pc.
	Pendard simple 2F						
	Zinkpox blanc	2F/ 280	717201		46	1302	66,78/pc.
		2F/ 370	717202		46	1302	72,44/pc.
		2F/ 505	717203		46	1302	82,27/pc.
		2F/ 730	717204		46	1302	98,23/pc.
		2F/ 1000	717205		46	1302	109,32/pc.
		2F/ 1500	787277		46	1302	164,83/pc.
		Pendard simple 2F					
Acier inoxydable AISI 316L		2F/ 280	725562		46	1305	106,82/pc.
		2F/ 370	725563	✓	46	1305	124,56/pc.
		2F/ 505	725564	✓	46	1305	157,73/pc.
		2F/ 730	725565	✓	46	1305	208,04/pc.
		2F/ 1000	725566	✓	46	1305	268,95/pc.
	2F/ 1500	787278		46	1305	469,63/pc.	

Echelles à câbles

	type	référence	stock	page. catal.	groupe d'articles	prix en €	
	Pendant double 20						
	Acier galvanisé à chaud	20/ 505	715723	✓	48	1313	68,89/pc.
		20/ 730	715724	✓	48	1313	83,79/pc.
		20/ 1000	715725	✓	48	1313	106,12/pc.
		20/ 1500	715726	✓	48	1313	138,52/pc.
		20/ 2000	715727	✓	48	1313	174,04/pc.
		20/ 3000	715728	✓	48	1313	288,19/pc.
	Pendant double 20						
	Zinkpox blanc	20/ 505	716276		48	1302	112,50/pc.
		20/ 730	716277		48	1302	135,63/pc.
	20/ 1000	716278		48	1302	165,70/pc.	
	20/ 1500	716279		48	1302	228,01/pc.	
	20/ 2000	716280		48	1302	319,10/pc.	
	20/ 3000	716281		48	1302	512,70/pc.	
	Pendant double 20						
	Acier inoxydable AISI 316L	20/ 505	725567	✓	48	1305	433,24/pc.
		20/ 730	725568	✓	48	1305	534,34/pc.
		20/ 1000	725569	✓	48	1305	643,31/pc.
		20/ 1500	725570		48	1305	838,26/pc.
		20/ 2000	725571		48	1305	1042,41/pc.
	20/ 3000	725572		48	1305	1470,41/pc.	
	Pendant double 20F						
	Acier galvanisé à chaud	20F/ 1000	718249		50	1313	133,65/pc.
		20F/ 1500	718250		50	1313	180,75/pc.
		20F/ 2000	718251		50	1313	223,90/pc.
	20F/ 3000	709799		50	1313	301,46/pc.	
	Pendant double 20F						
	Zinkpox blanc	20F/ 1000	718484		50	1302	216,71/pc.
		20F/ 1500	718485		50	1302	285,93/pc.
		20F/ 2000	718486		50	1302	414,90/pc.
	20F/ 3000	716282		50	1302	550,50/pc.	
	Pendant double 20FS						
	Acier galvanisé à chaud	20FS/ 1500	718718		52	1313	343,43/pc.
		20FS/ 2000	718719		52	1313	410,60/pc.
		20FS/ 2500	718720		52	1313	542,30/pc.
	20FS/ 3000	718721		52	1313	605,85/pc.	
	Pendant double 20FS						
	Zinkpox blanc	20FS/ 1000	720521		52	1302	670,20/pc.
		20FS/ 1500	720522		52	1302	797,70/pc.
		20FS/ 2000	720523		52	1302	989,19/pc.
	20FS/ 3000	720524		52	1302	1095,08/pc.	
	Profilé de suspension 24/34						
	Acier galvanisé Sendzimir	3000	721102	✓	54	1313	11,71/m
	↔ 3 m						
	Profilé de suspension 24/34						
	Acier galvanisé Sendzimir	300	725357		54	1313	6,98/pc.
		400	725358		54	1313	7,90/pc.
	 10 pc.	500	725359		54	1313	9,33/pc.
		700	725360		54	1313	12,13/pc.
		1000	725361		54	1313	15,82/pc.

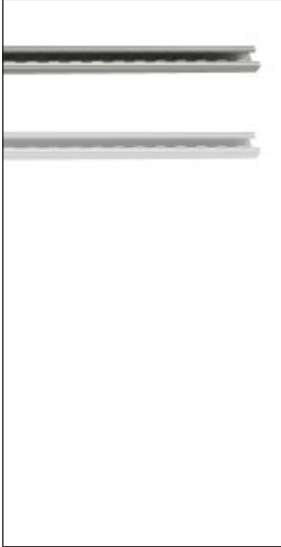
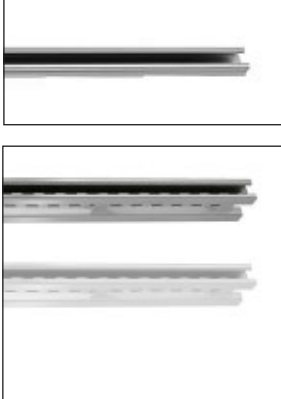











Echelles à câbles

	type	référence	stock	page. catal.	groupe d'articles	prix en €
	Profilé de suspension 24/34					
	Acier galvanisé à chaud	3000	715879	54	1313	20,12/m
	↔ 3 m					
	Profilé de suspension 24/34					
	Zinkpox wit	3000	716309	54	1302	33,47/m
	↔ 3 m					
	Profilé de suspension 24/34					
	Acier inoxydable AISI 316L	3000	725579	54	1305	68,74/m
↔ 3 m						
	Profilé de suspension 24/34					
	Acier inoxydable AISI 316L	300	725574	54	1305	20,63/pc.
	 10 pc.	400	725575	54	1305	27,50/pc.
		500	725576	54	1305	34,38/pc.
		700	725577	54	1305	49,04/pc.
		1000	725578	54	1305	68,74/pc.
		Profilé de suspension 24/48				
Acier galvanisé Sendzimir	3000	731717	✓	55	1313	26,08/m
↔ 3 m ↔ 6 m	6000	731721	✓	55	1313	26,08/m
Profilé de suspension 24/48						
Acier galvanisé à chaud	3000	705093	✓	55	1313	30,70/m
↔ 3 m ↔ 6 m	6000	731719	✓	55	1313	30,70/m
Profilé de suspension 24/48						
Zinkpox blanc	3000	716306	55	1302	48,16/m	
↔ 3 m ↔ 6 m	6000	731724	55	1302	48,24/m	
Profilé de suspension 24/48						
Acier inoxydable AISI 316L	3000	728595	55	1305	196,92/m	
↔ 3 m ↔ 6 m	6000	731727	55	1305	196,92/m	
Rail à encastrer 24/26 x 53						
Acier galvanisé à chaud	4000	768063	56	1313	42,28/m	
↔ 4 m						
Profilé de suspension 24/20						
Acier galvanisé à chaud	3000	709795	✓	57	1313	89,96/m
↔ 3 m						
Profilé de suspension 24/20						
Zinkpox blanc	3000	716307	57	1302	127,94/m	
↔ 3 m						

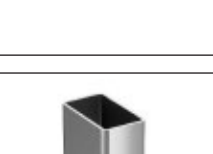









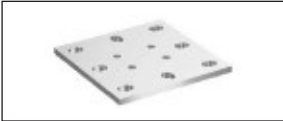



Echelles à câbles

	type	référence	stock	page. catal.	groupe d'articles	prix en €	
	Profilé de suspension 24/20F						
	Acier galvanisé à chaud	3000	709798		58	1313	119,59/m
	↔ 3 m ↔ 6 m	6000	718808		58	1313	119,59/m
	Profilé de suspension 24/20F						
	Zinkpox blanc	3000	716308		58	1302	154,66/m
	↔ 3 m ↔ 6 m	6000	720525		58	1302	154,66/m
	Profilé de suspension 24/20FS						
	Acier galvanisé à chaud	6000	709031		59	1313	168,56/m
	↔ 6 m						
	Profilé de suspension 24/20FS						
	Zinkpox blanc	6000	720526		59	1302	217,39/m
	↔ 6 m						
	Etrier de plafond TF-10						
	Acier galvanisé à chaud	TF10	788164		60	1313	20,36/pc.
	 10 pc.						
	Ecrou M10 inclus.						
	Etrier de plafond TF-16						
	Acier galvanisé à chaud	TF16	788165		60	1313	29,21/pc.
	 10 pc.						
	Ecrou M16 inclus.						
	Etrier de plafond 5						
	Acier galvanisé Sendzimir	5	721101		61	1313	10,38/pc.
	 10 pc.						
	Etrier de plafond 5						
	Acier galvanisé à chaud	5	718640	✓	61	1313	15,02/pc.
	 10 pc.						
	Etrier de plafond 5						
	Zinkpox blanc	5	716293		61	1302	30,93/pc.
	Etrier de plafond 5						
	Acier inoxydable AISI 316L	5	725573		61	1305	50,38/pc.
	Base pour pendar 520						
	Acier galvanisé à chaud	520	718253		62	1313	190,92/pc.
	Base pour pendar 520						
	Zinkpox blanc	520	718488		62	1302	249,79/pc.

Echelles à câbles

	type	référence	stock	page. catal.	groupe d'articles	prix en €	
	Etrier pour poutre en I 5BK						
	Acier galvanisé à chaud	5BK-10	715675	✓	63	1313	15,46/pc.
	10 pc.	5BK-30	718243	✓	63	1313	16,49/pc.
	Etrier pour poutre en I 5BK						
	Zinkpox blanc	5BK-10	716294		63	1302	18,36/pc.
		5BK-30	718487		63	1302	27,20/pc.
	Etrier de plafond 5TP						
	Acier galvanisé Sendzimir	5TP	725362		64	1313	10,85/pc.
	10 pc.	Etrier de plafond 5TP					
	Acier galvanisé à chaud	5TP	713153		64	1313	11,89/pc.
	10 pc.	Etrier de plafond 5TP					
	Zinkpox blanc	5TP	716295		64	1302	18,20/pc.
	Etrier de plafond 5TPA						
	Acier galvanisé Sendzimir	5TPA	732177	✓	65	1313	9,91/pc.
	10 pc.	Etrier de plafond 5TPA					
	Acier galvanisé à chaud	5TPA	733487		65	1313	11,58/pc.
	Support pour profilé 24/20F						
	Acier galvanisé à chaud	24/20F	718850		69	1313	144,41/pc.
	Support pour profilé 24/20F						
	Zinkpox blanc	24/20F	720527		69	1302	196,60/pc.
	Support pour profilé 24/20FS						
	Acier galvanisé à chaud	24/20FS	718851		69	1313	159,74/pc.
	Support pour profilé 24/20FS						
	Zinkpox blanc	24/20FS	720528		69	1302	218,14/pc.
	Etrier mural 20						
	Acier galvanisé à chaud	20	723450		70	1313	58,14/pc.
	Etrier mural 20F						
	Acier galvanisé à chaud	20F	723451		70	1313	58,76/pc.





Echelles à câbles

	type	référence	stock	page. catal.	groupe d'articles	prix en €	
	Etrier de plafond 20F						
	Acier galvanisé à chaud	20F	718849	71	1313	35,74/pc.	
	Etrier de plafond 20FS						
	Acier galvanisé à chaud	20FS	720536	71	1313	138,32/pc.	
	Equerre 5L						
	Acier galvanisé à chaud	5L	731791	✓	72	1313	17,01/pc.
	Zinkpox blanc	5L	731792	72	1302	33,69/pc.	
	Acier inoxydable AISI 316L	5L	731793	72	1305	49,56/pc.	
	 10 pc.						
	Equerre 5LS						
	Acier galvanisé à chaud	5LS	709801	✓	72	1313	19,61/pc.
	Zinkpox blanc	5LS	720529	72	1302	38,91/pc.	
	Acier inoxydable AISI 316L	5LS	725636	72	1305	54,85/pc.	
	Equerre HT-11						
	Acier galvanisé à chaud	HT-11	717618	✓	73	1313	21,10/pc.
	 25 pc.						
	Accouplement d'assemblage 2J						
	Acier galvanisé Sendzimir	2J	721119	74	1313	12,66/pc.	
	Acier galvanisé à chaud	2J	713177	74	1313	18,76/pc.	
	Zinkpox blanc	2J	716303	74	1302	24,62/pc.	
	Acier inoxydable 316L	2J	726484	74	1305	102,09/pc.	
	 10 pc.						
	Accouplement d'assemblage 2FJ						
	Acier galvanisé à chaud	2FJ	713178	74	1313	19,80/pc.	
	Zinkpox blanc	2FJ	716304	74	1302	25,83/pc.	
	Acier inoxydable 316L	2FJ	726485	74	1305	106,82/pc.	
	 10 pc.						
	Accouplement d'assemblage 20J						
	Acier galvanisé à chaud	20J	713173	74	1313	37,47/pc.	
	Zinkpox blanc	20J	716302	74	1302	48,15/pc.	
	 10 pc.						
	Renfort 1						
	Acier galvanisé à chaud	1/ 300	717640	75	1313	28,14/pc.	
		1/ 500	717641	75	1313	37,08/pc.	
		1/ 800	717642	75	1313	55,24/pc.	
	Renfort 1						
	Zinkpox blanc	1/ 300	717643	75	1302	45,48/pc.	
		1/ 500	717644	75	1302	45,87/pc.	
		1/ 800	717645	75	1302	64,64/pc.	



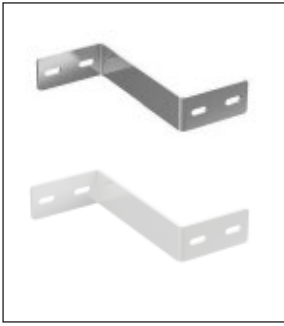



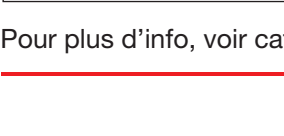







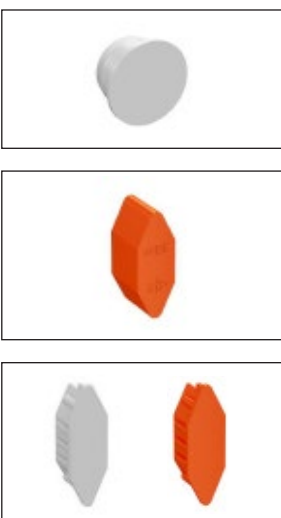

Echelles à câbles

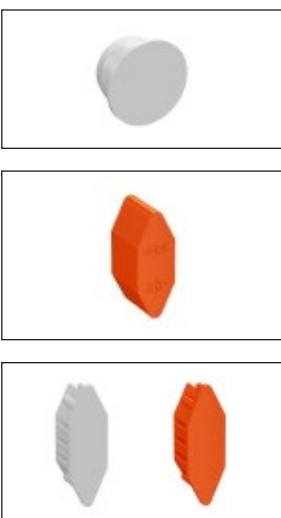
	type	référence	 stock	page. catal.	groupe d'articles	prix en €
	Renfort 1					
	Acier galvanisé à chaud	1/ 1500	718903		75 1313	166,24/pc.
	Renfort 1					
	Zinkpox blanc	1/ 1500	720530		75 1302	185,38/pc.
	Equerre 60/40					
	Acier galvanisé à chaud	60/ 40	718904		75 1313	17,01/pc.
	Zinkpox blanc	60/ 40	720531		75 1302	28,52/pc.
	 10 pc.					
	Accouplement 21					
	Zinc+	21	795051	✓	78 1313	14,02/pc.
	 10 pc.					
	Accouplement 21					
	Acier galvanisé à chaud	21	791199	✓	78 1313	16,75/pc.
	 10 pc.					
	Accouplement 21					
	Zinkpox blanc	21	791200	✓	78 1302	41,06/pc.
	 2 pc.					
	Accouplement 21					
	Acier inoxydable AISI 316L	21	725751	✓	78 1305	36,08/pc.
	 10 pc.					
	Accouplement 9					
	Acier galvanisé Sendzimir	9	721115	✓	79 1313	6,46/pc.
	 10 pc.					
	Accouplement 9					
	Acier galvanisé à chaud	9	705304	✓	79 1313	10,48/pc.
	 10 pc.					
	Accouplement 9					
	Zinkpox blanc	9	714066		79 1302	16,89/pc.
	 10 pc.					
	Boulon intermédiaire 29					
	Acier galvanisé à chaud	29/ 200	705392		79 1313	23,59/pc.
		29/ 300	705394		79 1313	27,04/pc.
		29/ 400	705395		79 1313	29,03/pc.
		29/ 500	705396		79 1313	33,90/pc.
		29/ 600	705397		79 1313	34,45/pc.
	 10 pc.					

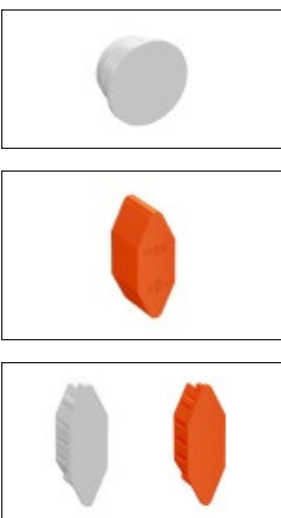
Echelles à câbles

	type	référence	stock	page. catal.	groupe d'articles	prix en €	
	Accouplement de branchement 32						
	Acier galvanisé à chaud	32	734713	✓	80	1313	83,14/pc.
	📦 2 pc.						
	Accouplement de branchement 32						
	Zinkpox blanc	32	780874		80	1302	142,45/pc.
	📦 2 pc.						
	Réduction 31						
	Acier galvanisé à chaud	31/ 100	734171		80	1313	44,84/pc.
		31/ 200	734172		80	1313	54,96/pc.
		31/ 300	734173		80	1313	67,43/pc.
		31/ 400	734174		80	1313	77,75/pc.
	Réduction 31						
	Zinkpox blanc	31/ 100	735433		80	1302	75,02/pc.
		31/ 200	735434		80	1302	83,96/pc.
		31/ 300	735435		80	1302	92,40/pc.
		31/ 400	735436		80	1302	103,66/pc.
	Accouplement 22						
	Acier galvanisé Sendzimir	22	721122	✓	81	1313	16,54/pc.
	📦 10 pc.						
	Accouplement 22						
	Acier galvanisé à chaud	22	718409	✓	81	1313	25,14/pc.
	📦 10 pc.						
	Accouplement 22						
	Zinkpox blanc	22	718410	✓	81	1302	40,31/pc.
	📦 10 pc.						
	Accouplement 22						
	Acier inoxydable AISI 316L	22	725760	✓	81	1305	51,53/pc.
	📦 10 pc.						
	Dérivation fixe crochet 4						
	Aluminium	4	709017	✓	82	1313	15,97/pc.
	📦 10 pc.						
	Dérivation fixe crochet 4						
	Aluminium blanc	4	714067		82	1302	17,80/pc.
	📦 10 pc.						
	Pied d'appui 10						
	Aluminium	10	709018	✓	82	1313	14,41/pc.
	📦 10 pc.						
	Pied d'appui 10						
	Aluminium blanc	10	714085		82	1302	18,39/pc.
	📦 10 pc.						

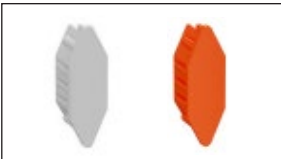
Echelles à câbles

	type	référence	stock	page. catal.	groupe d'articles	prix en €	
	Etrier 41						
	Acier galvanisé Sendzimir	41	725363	✓	83	1313	15,77/pc.
	 10 pc.						
	Etrier 41						
	Acier galvanisé à chaud	41	720824	✓	83	1313	25,19/pc.
	 10 pc.						
	Etrier 41						
	Zinkpox blanc	41	721945		83	1302	28,09/pc.
 10 pc.							
	Etrier 41						
	Acier inoxydable AISI 316L	41	783374		83	1305	45,82/pc.
	 10 pc.						
	Etrier mural						
	Acier galvanisé Sendzimir	11/25	721105	✓	84	1313	10,70/pc.
	 10 pc.	11/75	721106	✓	84	1313	12,33/pc.
	Etrier mural						
	Acier galvanisé à chaud	11/25	713204	✓	84	1313	16,01/pc.
 10 pc.	11/75	713203	✓	84	1313	16,68/pc.	
	Etrier mural						
	Zinkpox blanc	11/25	713208		84	1302	22,51/pc.
	 10 pc.	11/75	713207		84	1302	23,67/pc.
	Etrier mural						
	Acier inoxydable AISI 316L	11/25	725774	✓	84	1305	51,53/pc.
	 10 pc.	11/75	725775	✓	84	1305	56,77/pc.
	Bouchon de protection 27						
	Matière synthétique gris	27	726668	✓	84	1313	1,05/pc.
 100 pc.							
	Capuchon 28						
	Matière synthétique orange	28	709019	✓	85	1313	3,50/pc.
 50 pc.							
	Capuchon 28i						
	Matière synthétique blanc	28i	735446	✓	85	1313	3,50/pc.
	Matière synthétique orange	28i	731994	✓	85	1313	4,36/pc.
 10 pc.							







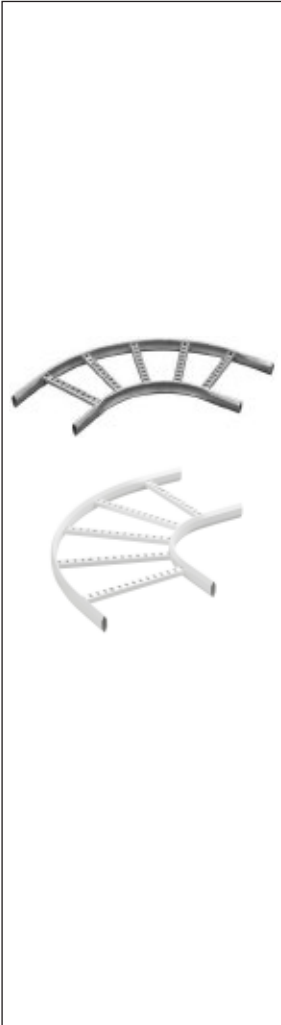
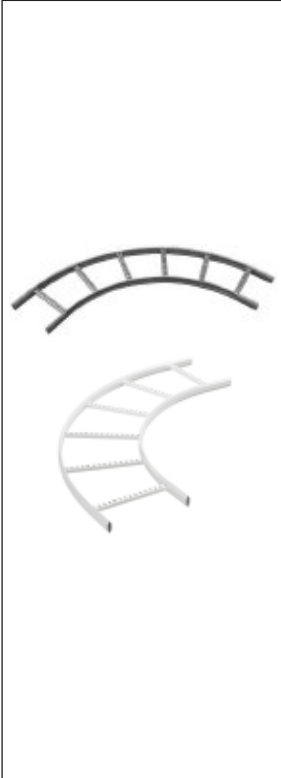



Echelles à câbles

	type	référence	stock	page. catal.	groupe d'articles	prix en €	
	Profilé de protection 28P						
	Matière synthétique gris	28P	732151	✓	85	1313	29,33/m
	↔ 2 m						
	Capuchon 28C						
	Matière synthétique orange	28C	789875		86	1313	2,79/pc.
	📦 50 pc. • Pour pendard 2 et profilé 24/34.						
	Capuchon 28E						
	Matière synthétique orange	28E	709021	✓	86	1313	5,82/pc.
	📦 50 pc. • Pour pendard 2F et 20F et profilé de suspension 24/48 et 24/20F.						
	Capuchon 28D						
	Matière synthétique orange	28D	709020	✓	86	1313	6,37/pc.
	📦 50 pc. • Pour pendard 20 et profilé de suspension 24/20.						
	Capuchon 28F						
	Matière synthétique orange	28F	789876		86	1313	7,22/pc.
	📦 10 pc. • Pour pendard 20FS et profilé de suspension 24/20FS.						
	Cornière 33/1						
	Acier galvanisé Sendzimir	33/ 1	768733		86	1313	13,71/pc.
	Cornière 33/1						
	Acier inoxydable AISI 316L	33/ 1	727340		86	1305	94,31/pc.
	Cornière 33/2						
	Acier galvanisé Sendzimir	33/ 2	721114		86	1313	71,82/pc.
	Cornière 33/2						
	Acier galvanisé à chaud	33/ 2	707748		86	1313	104,38/pc.
	Cornière 33/2						
	Zinkpox blanc	33/ 2	714168		86	1302	116,40/pc.
	Cornière 33/2						
	Acier inoxydable AISI 316L	33/ 2	727197		86	1305	119,09/pc.







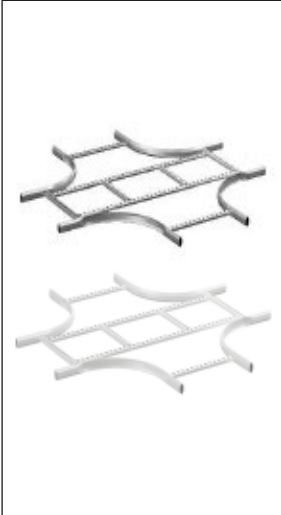
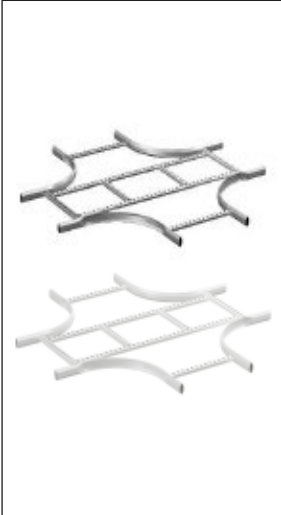



Echelles à câbles

	type	référence	🌀 stock	page. catal.	groupe d'articles	prix en €	
	Courbe intérieure 90°,15						
	Acier galvanisé Sendzimir	15/ 200	723061	✓	87	1313	156,09/pc.
		15/ 300	723062	✓	87	1313	165,65/pc.
		15/ 400	723063	✓	87	1313	168,63/pc.
		15/ 500	723064	✓	87	1313	197,93/pc.
		15/ 600	723065	✓	87	1313	205,39/pc.
	Courbe intérieure 90°,15						
	Acier galvanisé à chaud	15/ 150	716066	✓	87	1313	211,97/pc.
		15/ 200	716067	✓	87	1313	211,97/pc.
		15/ 300	716069	✓	87	1313	224,88/pc.
		15/ 400	716070	✓	87	1313	227,13/pc.
		15/ 500	716071	✓	87	1313	242,90/pc.
		15/ 600	716072	✓	87	1313	261,61/pc.
		15/ 800	721961		87	1313	459,61/pc.
		15/ 1000	716073		87	1313	530,64/pc.
Courbe intérieure 90°,15							
Zinkpox blanc	15/ 150	716074		87	1302	263,76/pc.	
	15/ 200	716075		87	1302	290,21/pc.	
	15/ 300	716077		87	1302	320,32/pc.	
	15/ 400	716078		87	1302	343,19/pc.	
	15/ 500	716079		87	1302	388,27/pc.	
	15/ 600	716080		87	1302	390,20/pc.	
	15/ 800	728043		87	1302	509,50/pc.	
	15/ 1000	716081		87	1302	584,91/pc.	
Courbe intérieure 90°,15							
Acier inoxydable AISI 316L	15/ 150	727346		87	1305	562,22/pc.	
	15/ 200	727347		87	1305	590,32/pc.	
	15/ 300	727348		87	1305	663,48/pc.	
	15/ 400	727349		87	1305	742,04/pc.	
	15/ 500	727350		87	1305	787,11/pc.	
	15/ 600	727351		87	1305	843,43/pc.	
	15/ 800	783376		87	1302	sur demande	
	15/ 1000	783377		87	1302	sur demande	
	Courbe extérieure 90°, 15						
	Acier galvanisé à chaud	15/ 150	716179		87	1313	314,54/pc.
		15/ 200	716180	✓	87	1313	336,56/pc.
		15/ 300	716182	✓	87	1313	360,92/pc.
		15/ 400	716183	✓	87	1313	392,57/pc.
		15/ 500	716184		87	1313	430,37/pc.
		15/ 600	716185	✓	87	1313	436,62/pc.
		15/ 800	723057		87	1313	621,89/pc.
		15/ 1000	723260		87	1313	853,99/pc.
	Courbe extérieure 90°, 15						
	Zinkpox blanc	15/ 150	716186		87	1302	350,82/pc.
		15/ 200	716187		87	1302	399,29/pc.
		15/ 300	716189		87	1302	450,76/pc.
		15/ 400	716190		87	1302	515,67/pc.
		15/ 500	716191		87	1302	663,07/pc.
	15/ 600	716192		87	1302	673,16/pc.	
	15/ 800	728052		87	1302	855,68/pc.	
	15/ 1000	728053		87	1302	1166,01/pc.	
Courbe extérieure 90°, 15							
Acier inoxydable AISI 316L	15/ 150	727352		87	1305	1413,94/pc.	
	15/ 200	727353		87	1305	719,65/pc.	
	15/ 300	727354		87	1305	792,63/pc.	
	15/ 400	727355		87	1305	916,23/pc.	
	15/ 500	727356		87	1305	1316,49/pc.	
	15/ 600	727357		87	1305	914,43/pc.	

Echelles à câbles

	type	référence	stock	page. catal.	groupe d'articles	prix en €		
	Accouplement 14							
	Acier galvanisé Sendzimir	14	723212	✓	88	1313	42,81/pc.	
	 10 pc.							
	Accouplement 14							
	Acier galvanisé à chaud	14	725096	✓	88	1313	67,43/pc.	
	 10 pc.							
	Accouplement 14							
	Zinkpox blanc	14	790906		88	1302	74,30/pc.	
 2 pc.								
	Accouplement 14							
	Acier inoxydable AISI 316L	14	727195		88	1305	105,32/pc.	
	 10 pc.							
	Pièce en T 16							
	Acier galvanisé à chaud	16/ 150	716193		88	1313	233,41/pc.	
		16/ 200	716194	✓	88	1313	236,99/pc.	
		16/ 300	716196	✓	88	1313	245,62/pc.	
		16/ 400	716197	✓	88	1313	261,41/pc.	
		16/ 500	716198	✓	88	1313	266,46/pc.	
		16/ 600	716199	✓	88	1313	282,26/pc.	
		16/ 800	721962		88	1313	655,89/pc.	
		16/ 1000	716200		88	1313	649,24/pc.	
	Pièce en T 16							
		Zinkpox blanc	16/ 150	716201		88	1302	532,70/pc.
			16/ 200	716202		88	1302	403,34/pc.
		16/ 300	716204		88	1302	442,22/pc.	
		16/ 400	716205		88	1302	466,43/pc.	
		16/ 500	716206		88	1302	520,62/pc.	
		16/ 600	716207		88	1302	521,69/pc.	
		16/ 1000	716208		88	1302	723,28/pc.	
Pièce en T 16								
	Acier inoxydable AISI 316L	16/ 150	727358		88	1305	809,50/pc.	
		16/ 200	727359		88	1305	730,93/pc.	
		16/ 300	727360		88	1305	820,82/pc.	
		16/ 400	727361		88	1305	921,98/pc.	
		16/ 500	727362		88	1305	1051,37/pc.	
		16/ 600	727363		88	1305	1265,00/pc.	
	Croisillon 17							
	Acier galvanisé à chaud	17/ 150	716209		89	1313	364,14/pc.	
		17/ 200	716210		89	1313	365,58/pc.	
		17/ 300	716212		89	1313	374,18/pc.	
		17/ 400	716213		89	1313	387,10/pc.	
		17/ 500	716214		89	1313	395,73/pc.	
		17/ 600	716215		89	1313	407,22/pc.	
		17/ 800	721963		89	1313	1017,23/pc.	
		17/ 1000	716216		89	1313	573,85/pc.	
	Croisillon 17							
		Zinkpox blanc	17/ 150	716217		89	1302	586,27/pc.
		17/ 200	716218		89	1302	637,07/pc.	
		17/ 300	716220		89	1302	688,29/pc.	
		17/ 400	716221		89	1302	718,55/pc.	
		17/ 500	716222		89	1302	749,42/pc.	
		17/ 600	716223		89	1302	802,62/pc.	
		17/ 1000	716224		89	1302	1125,92/pc.	

Echelles à câbles

	type	référence	📦 stock	page. catal.	groupe d'articles	prix en €	
	Pièce de montée 18						
	Acier galvanisé à chaud	18/ 150	718176	✓	90	1313	243,51/pc.
		18/ 200	718177	✓	90	1313	254,18/pc.
		18/ 300	718179	✓	90	1313	260,46/pc.
		18/ 400	718180	✓	90	1313	275,46/pc.
		18/ 500	718181	✓	90	1313	279,65/pc.
		18/ 600	718182	✓	90	1313	289,31/pc.
		18/ 800	721964		90	1313	354,08/pc.
		18/ 1000	718183		90	1313	375,44/pc.
		Pièce de montée 18					
Zinkpox blanc		18/ 150	718184		90	1302	271,55/pc.
		18/ 200	718185		90	1302	283,45/pc.
		18/ 300	718187		90	1302	290,46/pc.
		18/ 400	718188		90	1302	307,19/pc.
		18/ 500	718189		90	1302	313,00/pc.
		18/ 600	718190		90	1302	316,56/pc.
		18/ 800	728034		90	1302	485,85/pc.
		18/ 1000	718191		90	1302	441,45/pc.
		Pièce de montée 18					
	Acier inoxydable AISI 316L	18/ 150	727370		90	1305	528,32/pc.
		18/ 200	727371		90	1305	472,26/pc.
		18/ 300	727372		90	1305	566,71/pc.
		18/ 400	727373		90	1305	595,90/pc.
		18/ 500	727374		90	1305	627,42/pc.
	Courbe en S 67						
Acier galvanisé à chaud	67	788638		91	1313	110,22/pc.	
	Accouplement 45						
	Acier galvanisé à chaud	45	707609	✓	92	1313	68,58/pc.
	Accouplement 45						
	Zinkpox blanc	45	714227	✓	92	1302	76,44/pc.
	Accouplement 45						
	Acier inoxydable AISI 316L	45	792873	✓	92	1305	98,58/pc.
	Dérivation crochet 47						
	Acier galvanisé à chaud	47	791350	✓	92	1313	48,66/pc.
	Dérivation crochet 47						
	Zinkpox blanc	47	791401		92	1302	81,74/pc.
	Dérivation crochet 47						
	Acier inoxydable AISI 316L	47	792875		92	1305	sur demande

Echelles à câbles



Soutien pour profilé 46

	type	référence	stock	page. catal.	groupe d'articles	prix en €
Acier galvanisé à chaud	46	708001	✓	93	1313	21,43/pc.
 10 pc.						

Soutien pour profilé 46

Zinkpox blanc	46	714179		93	1302	30,31/pc.
 10 pc.						

Soutien pour profilé 46

Acier inoxydable AISI 316L	46	792877		93	1305	43,33/pc.
 10 pc.						

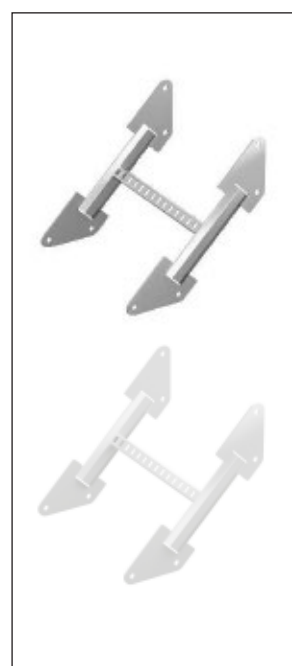

Pièce de montée 49

Acier galvanisé à chaud	49/ 200	716389	✓	93	1313	229,57/pc.
	49/ 300	716390	✓	93	1313	233,85/pc.
	49/ 400	716391	✓	93	1313	235,84/pc.
	49/ 500	720517		93	1313	236,86/pc.
	49/ 600	716392	✓	93	1313	236,86/pc.
	49/ 1000	716393		93	1313	270,48/pc.

Pièce de montée 49

Zinkpox blanc	49/ 200	716395		93	1302	245,30/pc.
	49/ 300	716396		93	1302	252,51/pc.
	49/ 400	716397		93	1302	267,86/pc.
	49/ 500	720518		93	1302	279,23/pc.
	49/ 600	716398		93	1302	290,86/pc.
	49/ 1000	716399		93	1302	302,53/pc.

Pièce de montée 49

Acier inoxydable AISI 316L	49/ 200	792880		93	1305	418,02/pc.
	49/ 300	792881		93	1305	419,52/pc.
	49/ 400	792882		93	1305	420,97/pc.
	49/ 500	792883		93	1305	422,91/pc.
	49/ 600	792884		93	1305	424,58/pc.
	49/ 1000	792886		93	1305	sur demande

Courbe 90°, 55

Acier galvanisé à chaud	55/ 200	716241	✓	94	1313	423,75/pc.
	55/ 300	716243	✓	94	1313	435,96/pc.
	55/ 400	716244	✓	94	1313	446,71/pc.
	55/ 500	716245		94	1313	466,83/pc.
	55/ 600	716246	✓	94	1313	468,97/pc.
	55/ 1000	716247		94	1313	792,17/pc.

Courbe 90°, 55













Zinkpox blanc	55/ 200	716248		94	1302	625,27/pc.
	55/ 300	716250		94	1302	674,11/pc.
	55/ 400	716251		94	1302	678,21/pc.
	55/ 500	720252		94	1302	sur demande
	55/ 600	716253		94	1302	796,31/pc.
	55/ 1000	716254		94	1302	940,38/pc.

Courbe 90°, 55

Acier inoxydable AISI 316L	55/ 200	792903		94	1305	1256,28/pc.
	55/ 300	792904		94	1305	1315,40/pc.
	55/ 400	792905		94	1305	1481,12/pc.
	55/ 500	792906		94	1305	1631,02/pc.
	55/ 600	792907		94	1305	1678,91/pc.
	55/ 1000	792909		94	1305	sur demande

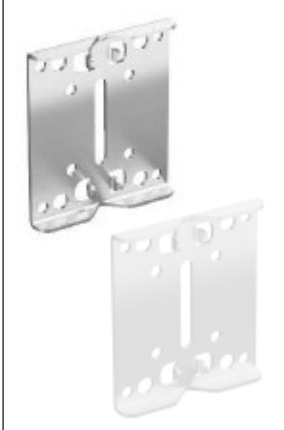









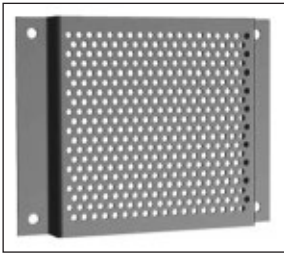

Echelles à câbles

	type	référence	stock	page. catal.	groupe d'articles	prix en €
	Pièce en T 56					
	Acier galvanisé à chaud	56/ 200	716255	94	1313	596,10/pc.
		56/ 300	716257	94	1313	610,46/pc.
		56/ 400	716258	94	1313	620,53/pc.
		56/ 500	716259	94	1313	637,73/pc.
		56/ 600	716260	94	1313	638,47/pc.
	56/ 1000	716261	94	1313	1041,39/pc.	
	Pièce en T 56					
	Zinkpox blanc	56/ 200	716262	94	1302	1033,70/pc.
		56/ 300	716264	94	1302	1114,38/pc.
		56/ 400	716265	94	1302	1143,44/pc.
		56/ 500	720266	94	1302	sur demande
		56/ 600	716267	94	1302	1245,46/pc.
	56/ 1000	716268	94	1302	1464,82/pc.	
	Pièce en T 56					
	Acier inoxydable AISI 316L	56/ 200	792920	94	1305	1712,07/pc.
		56/ 300	792921	94	1305	1864,04/pc.
		56/ 400	792922	94	1305	2022,11/pc.
		56/ 500	792923	94	1305	2022,11/pc.
		56/ 600	792924	94	1305	2123,52/pc.
	Boulonnerie M12					
	Acier galvanisé à chaud	M12	706415	✓	95	1313 13,13/set
	 25 sets					
	Boulonnerie M12					
	Acier inoxydable AISI 316L	M12	728767	95	1305	38,65/pc.
	 25 sets					
	Etrier 200 pour luminaire					
	Acier galvanisé à chaud	200	718643	95	1313	33,90/pc.
	Zinkpox blanc	200	718644	95	1302	37,29/pc.
	 10 pc.					
	Accouplement 44					
	Acier galvanisé à chaud	44	720815	✓	96	1313 93,31/pc.
	 2 pc.					
	Accouplement 44					
Zinkpox blanc	44	720816	96	1302	105,37/pc.	
 2 pc.						
Accouplement 44						
Acier inoxydable AISI 316L	44	792888	96	1305	167,12/pc.	
 2 pc.						

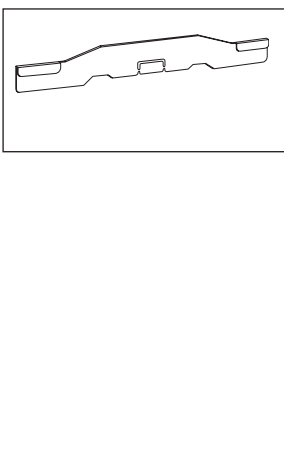









Echelles à câbles

	type	référence	stock	page. catal.	groupe d'articles	prix en €	
	Accouplement 51						
	Acier galvanisé à chaud	51	731837	✓	97	1313	145,62/pc.
	 2 pc.						
	Accouplement 51						
	Zinkpox blanc	51	731911		97	1302	205,32/pc.
	 2 pc.						
	Accouplement 51						
	Acier inoxydable AISI 316L	51	731914		97	1305	316,24/pc.
	 2 pc.						
	Plaque de montage 35P						
	Acier galvanisé Sendzimir	35P	718618		98	1313	25,47/pc.
	 10 pc.						
	Plaque de montage 35P						
	Acier galvanisé à chaud	35P	731745		98	1313	27,66/pc.
	 10 pc.						
	Plaque de montage 35P						
	Acier inoxydable AISI 316L	35P	725777		98	1305	53,42/pc.
	Plaque de montage 35S						
	Acier galvanisé Sendzimir	35S	711205	✓	99	1313	27,54/pc.
	 10 pc.						
	Plaque de montage 35S						
	Acier galvanisé à chaud	35S	731746	✓	99	1313	30,74/pc.
	 10 pc.						
	Plaque de montage 35S						
	Acier inoxydable AISI 316L	35S	725776		99	1305	44,47/pc.
	 10 pc.						
	Plaque de montage 35S						
	Acier galvanisé Sendzimir	35S	730245		99	1313	25,79/pc.
	 10 pc.						
	Borne de terre W79						
	Acier à zingage électrolytique	W79	716640		99	1313	4,71/pc.
	 100 pc.						













Echelles à câbles

	type	référence	stock	page. catal.	groupe d'articles	prix en €
	Plaque de montage 62					
	Acier galvanisé Sendzimir	62/100	783460	100	1313	21,50/pc.
		62/200	783461	100	1313	27,66/pc.
	Cloison de séparation 39					
	Acier galvanisé Sendzimir	H=24 L=1,75m	718835		103 1313	11,50/pc.
	 50 pc.					
	Cloison de séparation 39					
	Acier galvanisé à chaud	H=24 L=1,75m	731747	✓	103 1313	18,43/pc.
	 50 pc.					
	Cloison de séparation 39					
	Acier inoxydable AISI 316L	H=24 L=1,75m	725593		103 1305	63,70/pc.
	 50 pc.					
	Cloison de séparation 39					
	Acier galvanisé Sendzimir	H=55 L=1,75m	725785	✓	103 1313	12,60/pc.
	 30 pc.					
	Cloison de séparation 39					
	Acier galvanisé à chaud	H=55 L=1,75m	732983	✓	103 1313	21,71/pc.
	 30 pc.					
	Cloison de séparation 39					
	Acier inoxydable AISI 316L	H=55 L=1,75m	725594		103 1305	93,42/pc.
	 30 pc.					
	Accouplement W39 pour cloison de séparation 39					
	Matière synthétique	W39	716824	✓	103 1313	5,64/pc.
	 10 pc.					

Echelles à câbles

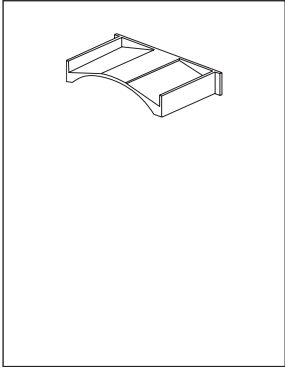
	type	référence	stock	page. catal.	groupe d'articles	prix en €	
	Plaque de protection 65						
	Acier galvanisé Sendzimir	200	732475	104	1313	251,08/pc.	
	L=1m	300	732476	104	1313	260,19/pc.	
		400	732477	104	1313	296,35/pc.	
		500	732478	104	1313	316,66/pc.	
	600	732479	104	1313	323,48/pc.		
	Plaque de protection 65						
	Acier galvanisé à chaud	200	730192	104	1313	282,78/pc.	
	L=1m	300	730193	104	1313	294,07/pc.	
		400	730194	104	1313	327,99/pc.	
		500	730195	104	1313	361,97/pc.	
	600	730196	104	1313	401,57/pc.		
	Plaque de protection 65						
	Acier inoxydable AISI 316L	200	732481	104	1305	966,71/pc.	
	L=1m	300	732482	104	1305	1224,43/pc.	
		400	732483	104	1305	1272,87/pc.	
		500	732484	104	1305	1742,09/pc.	
	600	732485	104	1305	1772,32/pc.		
	Fil à nouer						
	INOX, blanc PVC, ø 1,25 mm	HTR-2303	713686	105	1313	2,41/m	
	INOX, noir PVC, ø 1,25 mm	HTR-2313	713687	105	1313	2,69/m	
	blanc PVC, ø 1,5 mm	HTR-2304	713684	105	1313	0,81/m	
	noir PVC, ø 1,5 mm	HTR-2314	713685	✓	105	0,81/m	
	↔ 100 m						
	Goulotte télé- et datacom 36						
	Acier galvanisé Sendzimir	36/ 50	725065	106	1313	11,70/m	
	↔ 2 m	36/ 100	725066	106	1313	12,76/m	
		36/ 200	725067	106	1313	15,43/m	
	Goulotte télé- et datacom 36						
	Acier galvanisé à chaud	36/ 50	731748	106	1313	17,01/m	
	↔ 2 m	36/ 100	731749	106	1313	22,85/m	
		36/ 200	731750	106	1313	32,77/m	
	Goulotte télé- et datacom 36						
	Acier inoxydable AISI 316L	36/ 50	725590	106	1305	57,78/m	
	↔ 2 m	36/ 100	725591	106	1305	89,76/m	
		36/ 200	725592	106	1305	145,37/m	
	Etrier 12/70 ou 12/120						
	Acier galvanisé à chaud	12/70	728653	✓	108	1313	30,26/pc.
	 10 pc.	12/ 120	728654	✓	108	1313	32,68/pc.
	Etrier 12/70 ou 12/120						
	Acier inoxydable AISI 316L	12/70	728651	108	1305	43,95/pc.	
	 10 pc.	12/ 120	728652	108	1305	49,13/pc.	

Echelles à câbles

	type	référence	stock	page. catal.	groupe d'articles	prix en €	
	Crochet 8						
	Acier galvanisé à chaud	728642		108	1313	13,54/pc.	
	 10 pc.						
	Crochet 8						
	Acier inoxydable AISI 316L	728643		108	1305	25,87/pc.	
	 10 pc.						
	Pince à câbles, type ARX, pour 1 câble						
	Zink+	ARX1-12	795600		1313	4,35/pc.	
	 50 pc.	ARX1-16	795601		1313	4,70/pc.	
		ARX1-22	795602		1313	4,76/pc.	
		ARX1-28	795603		1313	5,13/pc.	
		ARX1-36	795604		1313	5,34/pc.	
		ARX1-44	795605		1313	5,53/pc.	
		ARX1-52	795606		1313	5,77/pc.	
		ARX1-60	795607		1313	5,83/pc.	
		ARX1-70	795608		1313	6,87/pc.	
	Pince à câbles, type ARX, pour 2 câbles						
	Zink+	ARX2-12	795609		1313	4,70/pc.	
	 50 pc.	ARX2-16	795610		1313	4,76/pc.	
		ARX2-22	795611		1313	5,34/pc.	
		ARX2-28	795612		1313	5,39/pc.	
		ARX2-36	795613		1313	5,83/pc.	
		ARX2-44	795614		1313	6,23/pc.	
		ARX2-52	795615		1313	8,20/pc.	
		ARX2-60	795616		1313	8,47/pc.	
	Protège-câble EM						
	Matière synthétique gris	EM - 12	709050		111	1313	2,55/pc.
	 100 pc.	EM - 16	709051		111	1313	2,55/pc.
		EM - 22	709052		111	1313	2,82/pc.
		EM - 28	709053		111	1313	2,82/pc.
	 50 pc.	EM - 36	709054		111	1313	2,82/pc.
		EM - 44	709055		111	1313	3,45/pc.
	 25 pc.	EM - 52	709056		111	1313	3,45/pc.
		EM - 60	709057		111	1313	3,45/pc.
EM - 70		709058		111	1313	3,45/pc.	
	Pince à câbles, type ER						
	Acier inoxydable AISI 316	23 - 28	736440		112	1313	179,09/pc.
		27 - 32	736441		112	1313	182,71/pc.
		30 - 35	736442		112	1313	184,98/pc.
		33 - 38	736443		112	1313	187,44/pc.
		36 - 42	736444		112	1313	199,51/pc.
		40 - 46	736445		112	1313	203,17/pc.
		44 - 50	736446		112	1313	206,78/pc.
		48 - 55	736447		112	1313	227,12/pc.
		51 - 58	736448		112	1313	230,76/pc.
		55 - 62	736449		112	1313	234,30/pc.
		59 - 66	736450		112	1313	267,89/pc.
		63 - 70	736451		112	1313	271,55/pc.
		67 - 74	736452		112	1313	275,15/pc.
	71 - 78	736453		112	1313	306,50/pc.	
	74 - 82	736454		112	1313	310,04/pc.	
	77 - 85	736455		112	1313	312,42/pc.	

Echelles à câbles

	type	référence	stock	page. catal.	groupe d'articles	prix en €
	Adaptateur pour pince ER					
	Acier inoxydable AISI 316	736456		112	1313	27,70/pc.
	 50 pc.					
	Pour échelon rond set de montage 74S inclus.					
	Boulonnerie 74S					
	Acier inoxydable AISI 316	74S 737198		112	1313	10,54/pc.
	 10 pc.					
	Deux sets sont nécessaire pour montage sur un échelon perforé.					
	Enrouleuse de câbles S					
	Acier galvanisé à chaud/ matière synthétique	S 718660	✓	114	1313	463,53/pc.
	Enrouleuse de câbles 38					
	Acier inoxydable/ matière synthétique	38 735998		115	1313	463,53/pc.
	Sac					
	Matière synthétique	780186		115	1313	430,92/pc.
	Set enrouleuses de câbles 66					
	Set composé de 1 sac et 10 enrouleuses 38.	66 780187		115	1313	4813,08/set
	Plaquette de marquage 93					
	Acier, laqué					
	jaune, RAL 1018	93 737704		116	1313	29,40/pc.
	orange, RAL 2008	93 737705		116	1313	29,40/pc.
	bleu, RAL 5012	93 737706		116	1313	29,40/pc.
	vert, RAL 6032	93 737707		116	1313	29,40/pc.
	noir, RAL 9005	93 737708		116	1313	29,40/pc.
	 10 pc.					
	Anti-corrosion zinc "GALVAFROID"					
	Pot 0,3 l	717637	✓	116	1313	109,16/pc.
	Peinture de retouche blanc					
	Bombe	739713		116	1302	126,64/pc.

Echelles à câbles



Couvercle W5

	type	référence	stock	page. catal.	groupe d'articles	prix en €	
←→ 2 m	Acier galvanisé Sendzimir	150	732216	✓	117	1313	13,70/m
		200	732217	✓	117	1313	16,84/m
		300	732218	✓	117	1313	22,37/m
		400	732219	✓	117	1313	32,73/m
		500	732220		117	1313	38,03/m
		600	732221		117	1313	52,39/m
		1000	732222		117	1313	129,69/m

Couvercle W5

←→ 2 m	Acier galvanisé à chaud	150	732264		117	1313	33,99/m
		200	732265		117	1313	35,06/m
		300	732266		117	1313	44,51/m
		400	732267		117	1313	57,14/m
		500	732268		117	1313	58,19/m
		600	732269		117	1313	69,77/m
		800	782213		117	1313	250,41/m
	1000	732270		117	1313	154,23/m	

Couvercle W5

←→ 2 m	Zinkpox blanc	150	782365		117	1302	91,75/m
		200	782366		117	1302	79,65/m
		300	782367		117	1302	106,91/m
		400	782368		117	1302	130,81/m
		500	782369		117	1302	152,17/m
		600	782370		117	1302	175,17/m
		800	782214		117	1302	sur demande
	1000	782371		117	1302	364,07/m	

Couvercle W5

←→ 2 m	Acier inoxydable AISI 316L	150	732291		117	1305	108,98/m
		200	732292		117	1305	139,82/m
		300	732293		117	1305	175,33/m
		400	732294		117	1305	260,61/m
		500	732295		117	1305	310,09/m
		600	732296		117	1305	322,24/m
		800	783375		117	1305	732,65/m
	1000	732297		117	1305	812,16/m	

Raccord de couvercle













	Acier galvanisé Sendzimir	150	712639		118	1313	15,36/pc.
		200	712640		118	1313	16,64/pc.
		300	712642		118	1313	16,91/pc.
		400	712643		118	1313	19,87/pc.
		500	712644		118	1313	23,93/pc.
		600	712645		118	1313	25,62/pc.

Raccord de couvercle



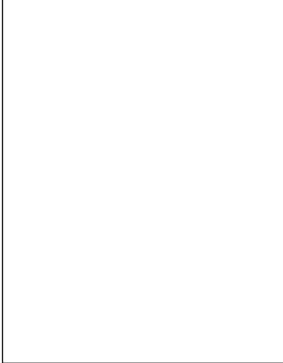





	Acier galvanisé à chaud	150	780452		118	1313	38,30/pc.
		200	780453		118	1313	40,08/pc.
		300	780454		118	1313	43,70/pc.
		400	780455		118	1313	45,56/pc.
		500	780456		118	1313	49,20/pc.
		600	780457		118	1313	51,02/pc.

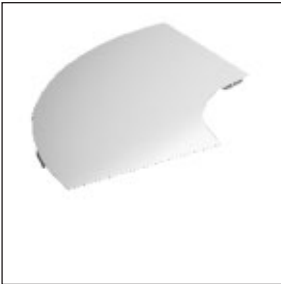
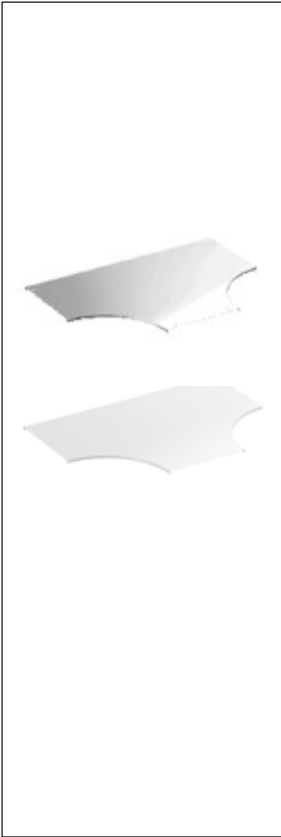









Echelles à câbles

	type	référence	stock	page. catal.	groupe d'articles	prix en €
	Support de couvercle 37					
	Acier galvanisé Sendzimir	37	729217	✓	119 1313	6,44/pc.
	 10 pc.					
	Support de couvercle 37					
	Acier galvanisé à chaud	37	730188	✓	119 1313	8,40/pc.
	 10 pc.					
	Support de couvercle 37					
	Zinkpox blanc	37	782382		119 1302	12,14/pc.
 10 pc.						
Support de couvercle 37						
	Acier inoxydable AISI 316L	37	730190		119 1305	18,06/pc.
	 10 pc.					
	Etrier de couvercle					
	Zinc+		795598	✓	119 1313	6,66/pc.
 10 pc.						
Etrier de couvercle						
	Zinkpox blanc		782384		119 1312	8,33/pc.
	 10 pc.					
	Etrier de couvercle					
	Acier inoxydable AISI 316L		728586		119 1305	8,95/pc.
 10 pc.						
Couvercle courbe 90°						
	Acier galvanisé Sendzimir	150	732322		120 1313	146,87/pc.
		200	732323		120 1313	162,46/pc.
		300	732324		120 1313	188,00/pc.
		400	732325		120 1313	229,57/pc.
		500	732326		120 1313	273,62/pc.
		600	732327		120 1313	296,35/pc.
		800	781802		120 1313	366,34/pc.
		1000	732328		120 1313	386,35/pc.
	Couvercle courbe 90°					
	Acier galvanisé à chaud	150	781433		120 1313	116,73/pc.
		200	781434		120 1313	146,46/pc.
		300	781435		120 1313	164,80/pc.
		400	781436		120 1313	204,94/pc.
	500	781437		120 1313	217,67/pc.	
	600	781438		120 1313	247,92/pc.	
	800	781793		120 1313	711,31/pc.	
	1000	781439		120 1313	455,12/pc.	
Couvercle courbe 90°						
Zinkpox blanc	150	781751		120 1302	151,15/pc.	
	200	781752		120 1302	173,65/pc.	
	300	781753		120 1302	218,42/pc.	
	400	781754		120 1302	287,85/pc.	
	500	781755		120 1302	327,21/pc.	
	600	781756		120 1302	383,49/pc.	
	800	781794		120 1302	903,04/pc.	
	1000	781757		120 1302	784,95/pc.	

Echelles à câbles

	type	référence	stock	page. catal.	groupe d'articles	prix en €
	Couvercle courbe 90°					
	Acier inoxydable AISI 316L	150	788639	120	1305	170,57/pc.
		200	788640	120	1305	189,32/pc.
		300	788641	120	1305	250,75/pc.
		400	788642	120	1305	457,43/pc.
		500	788643	120	1305	481,07/pc.
		600	788644	120	1305	638,47/pc.
		800	788645	120	1305	1135,11/pc.
	1000	788646	120	1305	2325,03/pc.	
	Couvercle pièce en T					
	Acier galvanisé Sendzimir	150	732345	121	1313	164,48/pc.
		200	732346	121	1313	200,24/pc.
		300	732347	121	1313	218,07/pc.
		400	732348	121	1313	233,95/pc.
		500	732349	121	1313	271,48/pc.
		600	732350	121	1313	300,83/pc.
		800	781803	121	1313	511,36/pc.
		1000	732351	121	1313	454,17/pc.
		Couvercle pièce en T				
Acier galvanisé à chaud		150	781440	121	1313	144,21/pc.
		200	781441	121	1313	169,97/pc.
		300	781442	121	1313	204,38/pc.
		400	781443	121	1313	248,13/pc.
		500	781444	121	1313	300,66/pc.
		600	781445	121	1313	325,79/pc.
		800	781796	121	1313	676,17/pc.
		1000	781446	121	1313	844,87/pc.
	Couvercle pièce en T					
	Zinkpox blanc	150	781765	120	1302	203,04/pc.
		200	781766	120	1302	239,08/pc.
		300	781767	120	1302	351,13/pc.
		400	781768	120	1302	355,77/pc.
		500	781769	120	1302	462,17/pc.
		600	781770	120	1302	505,99/pc.
		1000	781771	120	1302	1120,04/pc.
	Couvercle pièce en T					
	Acier inoxydable AISI 316L	150	788647	121	1305	238,07/pc.
		200	788648	121	1305	293,77/pc.
		300	788649	121	1305	359,50/pc.
		400	788650	121	1305	655,89/pc.
		500	788651	121	1305	1119,87/pc.
		600	788652	121	1305	1135,97/pc.
		800	788653	121	1305	2361,63/pc.
	1000	781654	121	1305	sur demande	
	Set de montage 2S					
	Acier galvanisé à chaud	M8x40	715735	✓	130	1313
	 10 pc.					
	Set de montage 20S					
	Acier galvanisé à chaud	M8x60	715736	✓	130	1313
	 10 pc.					

Echelles à câbles

	type	référence	stock	page. catal.	groupe d'articles	prix en €	
	Set de montage 22S						
	Acier galvanisé à chaud	M8x16	713694	✓	130	1313	1,04/pc.
	 10 pc.						
	Set de montage 22S						
	Acier inoxydable AISI 316L	M8x16	725582		130	1305	8,87/pc.
	 10 pc.						
	Ecrou coulissant pour échelons perforés						
	Acier galvanisé à chaud	M8	718632	✓	131	1313	3,99/pc.
	 10 pc.						
	Boulon en T 26F						
	Acier à zingage électrolytique	M8x30	734983	✓	133	1313	6,30/pc.
		M10x30	734864	✓	133	1313	6,39/pc.
		 10 pc.					
	Boulon en T 26F						
	Acier galvanisé à chaud	M8x30	734744	✓	133	1313	6,47/pc.
	M10x30	716794	✓	133	1313	6,52/pc.	
	M10x40	716795	✓	133	1313	8,61/pc.	
	M10x50	716796	✓	133	1313	9,34/pc.	
	 10 pc.						
Boulon en T 26F							
Acier inoxydable AISI 316L	M8x30	734986		133	1305	69,61/pc.	
	M10x30	728596		133	1305	64,31/pc.	
	M10x50	728598		133	1305	68,25/pc.	
	 10 pc.						



KG 281

KG 281

KG 281

KB 184

W4

Gaines à câbles KG 281

Chemins de câbles KB 184

Gaines et chemins de câbles W4

- ✓ La gamme la plus complète de gaines et chemins de câbles.
- ✓ Un choix étendu d'accessoires.
- ✓ Des raccordements sans vis, tels que des éclisses à boulonner, des ressorts d'accouplement, des verrous, des plaques de montage, etc. qui sont en outre faciles à monter et peu coûteux.
- ✓ Un choix étendu de fixations (encliquetables), adaptées à chaque sens de montage.
- ✓ Grâce au double rebord :
 - solidité renforcée ;
 - aucun risque d'endommagement du matériel ou de blessure ;
 - aucun endommagement lors de la pose de câbles.
- ✓ Esthétiquement les plus belles gaines/les plus beaux chemins de câbles :
 - élégants et jolis ;
 - disponibles en finition laquée, résistants aux rayures.



© Severin Maltaud

Les gaines à câbles STAGO

Design et fonctionnalité vont de pair

Les gaines à câbles constituent une partie importante de l'installation électrique. Après tout, les câbles doivent être transportés à travers le bâtiment d'une manière simple.

La flexibilité et la facilité de montage sont des caractéristiques essentielles pour un tel système de porteurs de câbles.

Mais saviez-vous que les gaines à câbles ont également une **valeur esthétique** ? Alors qu'on les installait auparavant exclusivement au-dessus du faux plafond, elles sont à présent montées de façon apparente selon la tendance du **look industriel**. La gamme des gaines à câbles STAGO en **version métallique et laquée** s'intègre parfaitement dans le nouvel intérieur industriel élégant qui regorge de matériaux robustes aux accents métalliques ou laqués. Conformément à cette nouvelle tendance, les bureaux, les magasins, les entreprises de restauration, ainsi que les habitations privées sont équipés de ces gaines à câbles STAGO originales, ce qui permet de parfaitement combiner l'aspect fonctionnel avec le nouveau look industriel.

Les gaines à câbles STAGO: une touche d'originalité dans tout intérieur moderne et industriel!

Les caractéristiques du système de gaines à câbles STAGO en un clin d'œil :

- Fonctionnel
- Élégant – adapté à tout intérieur industriel moderne
- Esthétique et épuré
- Qualitatif
- Disponible en stock en trois finitions : métallique, laqué noir et laqué blanc

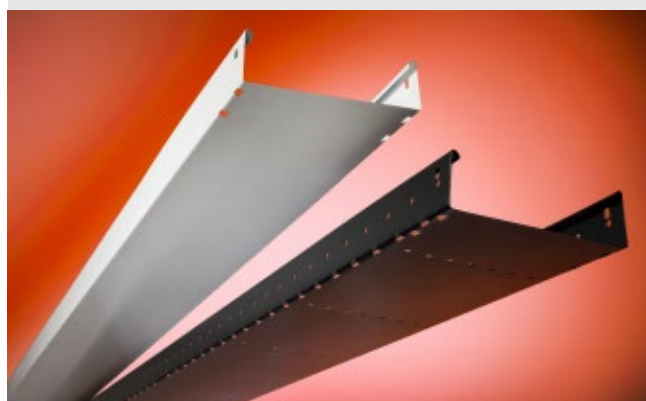









Aperçu

KG281	KG281	KG281	KB184	W4
perforations latérales	perforations latérales / opercules défonçables	complètement fermé	perforé	perforé
				

Caractéristiques

G.S.	✓	✓	✓	✓	✓
H.D.					✓
Laqué	✓		✓		
◀ mm	70-600	70-330	70-330	100-600	50-400
⬆ mm	60	60	60	60	15
L mm	3000	3000	3000	3000	3000 (B ≤ 250) 1960 (B ≥ 300)

Applications

 Tertiaire	✓	✓	✓	✓	✓
 Industrie				✓	✓
 Centres de données				✓	
 Installations PV				✓	✓
 Industrie alimentaire				✓	✓
 Pétrochimie				✓	✓
 G.S.	page 42	page 42	page 42	page 42	page 40
 H.D.	-	-	-	-	page 41
Laqué	page 42		page 42		

G.S.

galvanisation Sendzimir NBN EN 10346 – recommandé dans les environnements corrosifs C2 (faible)

H.D.

galvanisation à chaud NBN EN ISO 1461 – recommandé dans les environnements corrosifs C3/C4 (moyen/haut)

Laqué

Galvanisation Sendzimir et pourvu d'un poudrage électrostatique en noir (RAL 9005) ou blanc (RAL 9010).

Les autres couleurs RAL sur demande.









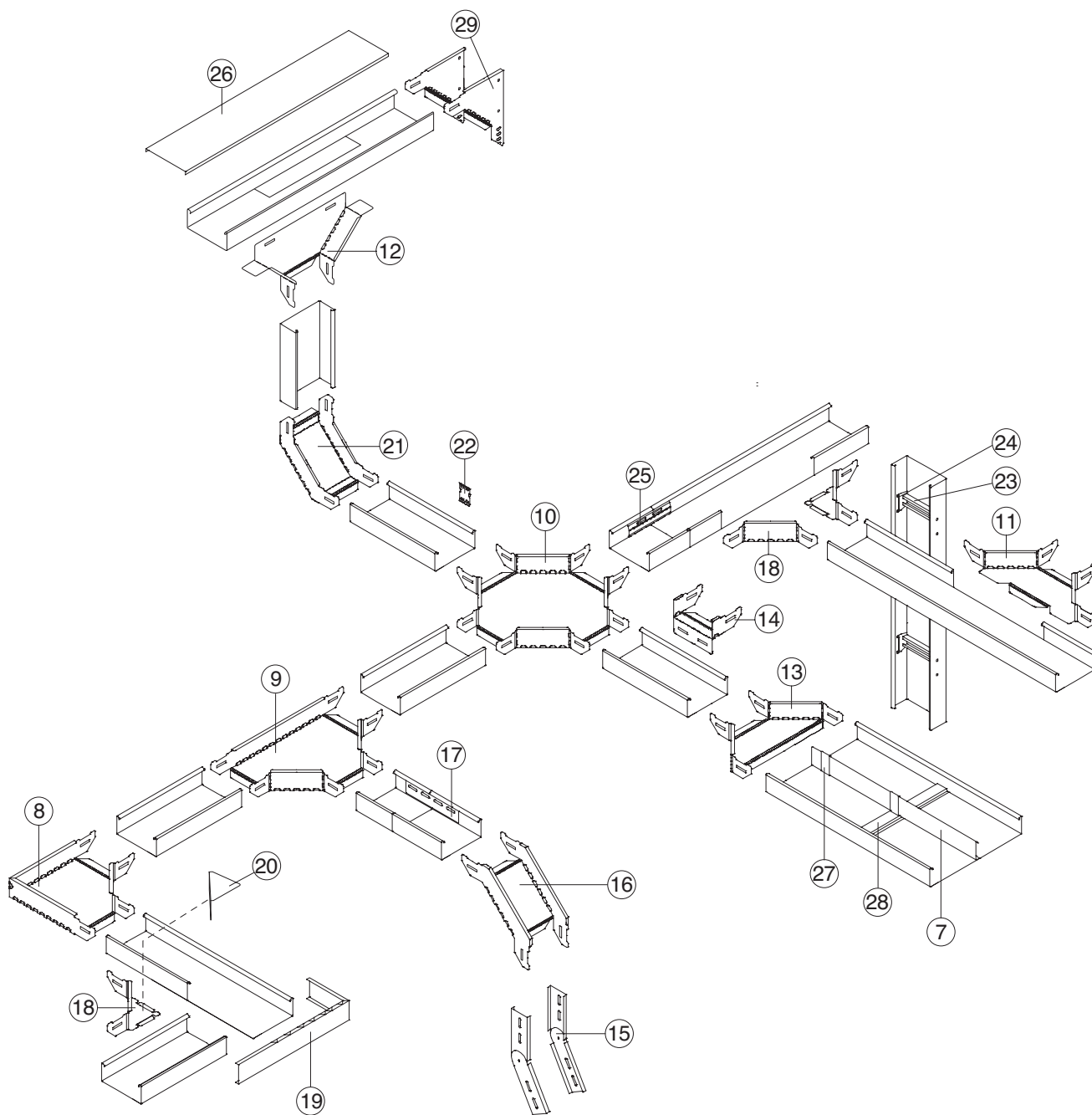
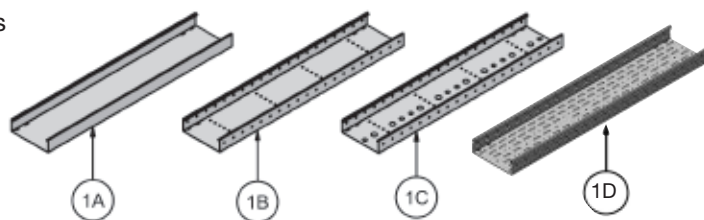

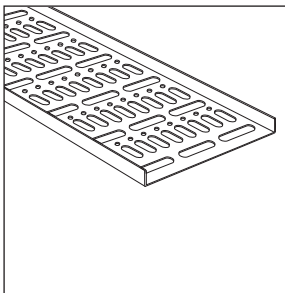

voir page 2

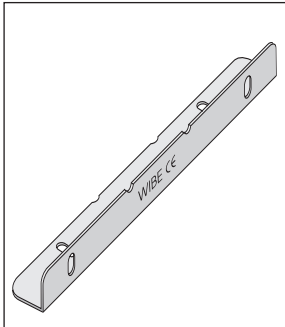

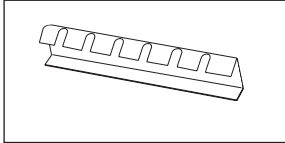

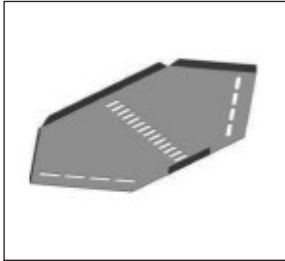

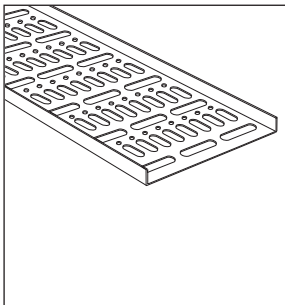

Vue d'ensemble

- 1A – Gaine à câbles KG 281 non perforée
- 1B – Gaine à câbles KG 281 avec perforations latérales
- 1C – Gaine à câbles KG 281 avec perforations latérales et opercules défonçables
- 1D – Chemin de câbles KB 184

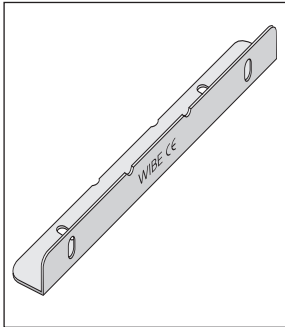

- | | | |
|---|--|-------------------------------------|
| 7 - Cloison de séparation | 16 - Raccord de descente | 23 - Echelon |
| 8 - Pièce d'angle | 17 - Accouplement | 24 - Fixation pour échelon |
| 9 - Pièce en T | 18 - Dérivation universelle | 25 - Accouplement sans vis |
| 10 - Croisillon | 19 - Accouplement / pièce de réduction | 26 - Couvercle |
| 11 - Dérivation | 20 - Couvercle pour dérivation universelle | 27 - Verrou pour cloison |
| 12 - Pièce murale verticale | 21 - Raccord de montée | 28 - Etrier de fond |
| 13 - Réduction | 22 - Fixation pour accessoire | 29 - Pièce en T verticale terminale |
| 14 - Dérivation surélevée | | |
| 15 - Raccord de descente: montée réglable | | |

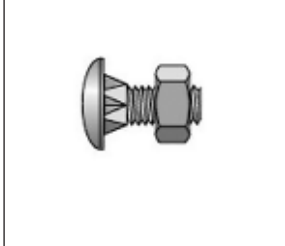
	type	référence	📦 stock	page. catal.	groupe d'articles	prix en €	
	Chemins de câbles W4						
	Acier galvanisé Sendzimir	50	735988	✓	46	1306	8,88/m
		75	735989	✓	46	1306	11,60/m
		100	735990	✓	46	1306	14,33/m
	↔ 3 m  6 m	150	735991	✓	46	1306	17,30/m
		200	735992	✓	46	1306	23,09/m
		250	735993		46	1306	29,92/m
	↔ 2 m	300	736609		46	1306	32,70/m
		400	736610		46	1306	40,74/m
		Accouplement W2					
Acier galvanisé Sendzimir			788572	✓	46	1306	5,55/pc.
	 10 pc.						
	Accouplement universel W4						
	Acier galvanisé Sendzimir		70510	✓		1306	2,80/pc.
	 20 pc.						
	Courbe 90° W4						
	Acier galvanisé Sendzimir	50	784073		46	1306	41,79/pc.
		75	784074		46	1306	44,19/pc.
		100	784075		46	1306	46,57/pc.
		150	784076		46	1306	52,54/pc.
		200	784077		46	1306	60,31/pc.
		250	784078		46	1306	67,46/pc.
	300	784079		46	1306	76,42/pc.	
	400	784080		46	1306	96,14/pc.	
	Pièce de montée/descente W4						
	Acier galvanisé Sendzimir	50	784089		47	1306	45,98/pc.
		75	784090		47	1306	50,14/pc.
		100	784091		47	1306	51,94/pc.
		150	784092		47	1306	59,13/pc.
		200	784093		47	1306	67,46/pc.
		250	784094		47	1306	75,23/pc.
		300	784095		47	1306	83,59/pc.
	400	784096		47	1306	97,92/pc.	
	Set de montage W34						
	Acier à zingage électrolytique	M6	718473	✓	58	1306	1,19/pc.
	 100 pc.						

	type	référence	stock	page. catal.	groupe d'articles	prix en €	
	Chemins de câbles W4						
	Acier galvanisé à chaud	50	735977	✓	46	1306	12,02/m
		75	735978		46	1306	14,64/m
		100	735979	✓	46	1306	19,23/m
	↔ 3 m  6 m	150	735980		46	1306	23,79/m
		200	735981		46	1306	33,24/m
		250	735982		46	1306	42,30/m
	↔ 2 m	300	736619		46	1306	47,22/m
		400	736620		46	1306	57,74/m
		Accouplement W2					
Acier galvanisé à chaud			788573	✓	46	1306	6,57/pc.
	 10 pc.						
	Courbe 90° W4						
	Acier galvanisé à chaud	50	784081		46	1306	46,57/pc.
		75	784082		46	1306	48,95/pc.
		100	784083		46	1306	51,94/pc.
		150	784084		46	1306	60,90/pc.
		200	784085		46	1306	72,89/pc.
		250	784086		46	1306	77,02/pc.
		300	784087		46	1306	92,55/pc.
	400	784088		46	1306	112,85/pc.	
	Pièce de montée/descente W4						
	Acier galvanisé à chaud	50	784097		47	1306	50,75/pc.
		75	784098		47	1306	54,33/pc.
		100	784099		47	1306	56,72/pc.
		150	784100		47	1306	63,90/pc.
		200	784101		47	1306	74,04/pc.
		250	784102		47	1306	79,41/pc.
		300	784103		47	1306	90,75/pc.
	400	784104		47	1306	115,23/pc.	
	Set de montage W38P						
	Dacromet	M6	733258	✓	58	1306	1,43/pc.
	 100 pc.						



Gaine à câbles KG281 à parois latérales perforées H=60 mm, épaisseur 0,8 mm

type	référence	stock	page. catal.	groupe d'articles	prix en €
Acier galvanisé Sendzimir ↔ 3 m  6 m	70	8601202	✓	24 1101	10,85/m
	120	8602202	✓	24 1101	12,15/m
	200	8603202	✓	24 1101	16,26/m
	250	8604202		24 1101	18,29/m

Gaine à câbles KG281 à parois latérales perforées H=60 mm, épaisseur 1 mm

Acier galvanisé Sendzimir ↔ 3 m  6 m	70	8601204	✓	24 1101	12,70/m
	120	8602204	✓	24 1101	15,10/m
	200	8603204	✓	24 1101	19,56/m
	250	8604204	✓	24 1101	23,45/m
	330	8605204	✓	24 1101	29,10/m
	400	8606204	✓	24 1101	35,26/m

Gaine à câbles KG281 à parois latérales perforées H=60 mm, épaisseur 1 mm

Acier galvanisé Sendzimir, laquage par poudrage blanc RAL 9010 ↔ 3 m	120	8602204UP9010N	-	1101	26,41/m
	200	8603204UP9010N	-	1101	34,26/m
	330	8605204UP9010N	-	1101	50,93/m

Gaine à câbles KG281 à parois latérales perforées H=60 mm, épaisseur 1 mm

Acier galvanisé Sendzimir, laquage par poudrage noir RAL 9005 ↔ 3 m	120	8602204UP9005N	✓	- 1101	26,41/m
	200	8603204UP9005N	✓	- 1101	34,26/m
	330	8605204UP9005N	✓	- 1101	50,93/m

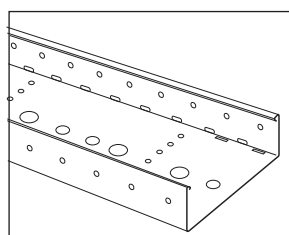

Gaine à câbles KG281 à parois latérales perforées et avec opercules défonçables H=60 mm, E=1mm

Acier galvanisé Sendzimir ↔ 3 m  6 m	70	8601004	✓	24 1101	13,33/m
	120	8602004	✓	24 1101	15,82/m
	200	8603004	✓	24 1101	20,55/m
	250	8604004	✓	24 1101	24,62/m
	330	8605004		24 1101	30,55/m

Gaine à câbles KG281 non perforée H=60mm, épaisseur 1 mm

Acier galvanisé Sendzimir ↔ 3 m  6 m	70	8601404	✓	24 1101	12,70/m
	120	8602404	✓	24 1101	15,10/m
	200	8603404	✓	24 1101	19,56/m
	250	8604404	✓	24 1101	23,45/m
	330	8605404	✓	24 1101	34,57/m

Gaine à câbles KG281 non perforée H=60mm, épaisseur 1 mm

Acier galvanisé Sendzimir, laquage par poudrage blanc RAL 9010 ↔ 3 m	120	8602404UP9010N	-	1101	26,41/m
	200	8603404UP9010N	✓	- 1101	34,26/m
	330	8605404UP9010N	-	1101	60,51/m

Gaine à câbles KG281 non perforée H=60mm, épaisseur 1 mm

Acier galvanisé Sendzimir, laquage par poudrage noir RAL 9005 ↔ 3 m	120	8602404UP9005N	✓	- 1101	26,41/m
	200	8603404UP9005N	✓	- 1101	34,26/m
	330	8605404UP9005N	✓	- 1101	60,51/m

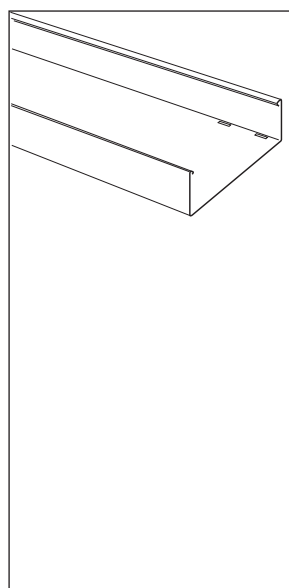

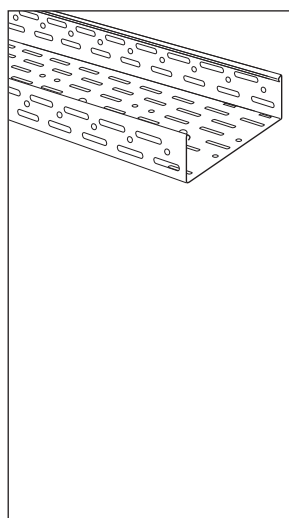

Chemin de câbles KB 184, H = 60 mm, épaisseur 1 mm

type	référence	stock	page. catal.	groupe d'articles	prix en €	
Acier galvanisé Sendzimir	100	76011004	✓	25	1102	14,38/m
↔ 3 m  6 m	150	76011504	✓	25	1102	17,07/m
	200	76012004	✓	25	1102	19,56/m
	250	76012504	✓	25	1102	23,45/m
	300	76013004	✓	25	1102	25,64/m
	400	76014004	✓	25	1102	33,29/m
	500	76015004	✓	25	1102	45,89/m
	600	76016004	✓	25	1102	52,85/m

Chemin de câbles KB 184, H = 60 mm, épaisseur 1,5 mm

Acier galvanisé Sendzimir	100	76011006	✓	25	1102	26,33/m
↔ 3 m  6 m	200	76012006	✓	25	1102	34,54/m
	300	76013006	✓	25	1102	45,36/m
	400	76014006	✓	25	1102	55,06/m
	500	76015006	✓	25	1102	66,22/m
	600	76016006	✓	25	1102	77,56/m

Accouplement

Acier galvanisé Sendzimir	200	80100	✓	26	1101	1,61/pc.
---------------------------	-----	-------	---	----	------	----------

 10 pc.

Accouplement d'accouplement pour toutes épaisseurs.

Unilock

Acier galvanisé Sendzimir		8010109	✓	26	1101	1,61/pc.
---------------------------	--	---------	---	----	------	----------

 10 pc.

Accouplement sans vis pour épaisseurs 0,8 mm et 1 mm.

Raccord de descente et de montée, H = 60 mm

Acier galvanisé Sendzimir		8750000	✓	37	1122	11,87/set
---------------------------	--	---------	---	----	------	-----------

 10 sets

Set pour les gaines à câbles KG281.

Raccord de descente et de montée, H = 60 mm

Acier galvanisé Sendzimir		76120009	✓	37	1122	6,94/pc.
---------------------------	--	----------	---	----	------	----------

 20 pc.

Pour chemins de câbles KB 184.

Cloison de séparation, H = 55 mm

Acier galvanisé Sendzimir		88701	✓	27	1101	6,39/m
---------------------------	--	-------	---	----	------	--------

↔ 3 m  30 m





Verrou pour cloison de séparation

Acier galvanisé Sendzimir		88705	✓	27	1101	0,51/pc.
---------------------------	--	-------	---	----	------	----------

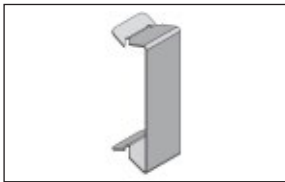

 50 pc.

Etrier de fond

Acier galvanisé Sendzimir	70	88712	✓	27	1101	5,97/pc.
	120	88722	✓	27	1101	6,32/pc.
 10 pc.	200	88732	✓	27	1101	6,82/pc.
	250	88742	✓	27	1101	7,21/pc.
	330	88752	✓	27	1101	8,24/pc.

	type	référence	stock	page. catal.	groupe d'articles	prix en €	
	Cloison de séparation, H = 55 mm						
	Acier galvanisé Sendzimir	760200	✓	28	1102	8,25/m	
	↔ 3 m  30 m						
	Echelon						
	Acier galvanisé Sendzimir	70	81512		28	1101	3,81/pc.
	 10 pc.	120	81522		28	1101	4,63/pc.
		200	81532		28	1101	5,29/pc.
		250	81542		28	1101	6,09/pc.
		300	81550		28	1101	7,22/pc.
		330	81552		28	1101	7,38/pc.
		400	81562		28	1101	8,73/pc.
500		81572		28	1101	9,49/pc.	
600	81582		28	1101	11,20/pc.		
	Fixation pour échelon						
	Acier galvanisé Sendzimir	81504		28	1101	1,71/pc.	
	 24 pc.						
	Couvercle						
	Acier galvanisé Sendzimir	70	8161003	✓	29	1101	8,24/m
	↔ 2 m  4 m	100	8161103	✓	29	1101	10,70/m
		120	8162003	✓	29	1101	12,30/m
		150	8161503	✓	29	1101	13,89/m
		200	8163003	✓	29	1101	17,07/m
		250	8164003	✓	29	1101	19,77/m
		300	8164303	✓	29	1101	22,68/m
		330	8165004	✓	29	1101	30,78/m
		400	8166004	✓	29	1101	33,19/m
500		8167004	✓	29	1101	38,56/m	
600	8168004	✓	29	1101	53,12/m		
	Attache universelle						
	Acier inoxydable	88550	✓	29	1101	1,05/pc.	
	 100 pc.						
	Attache extérieure						
	Acier inoxydable	H= 60mm	762400	✓	29	1101	2,07/pc.
	 20 pc.						
	Attache						
	Acier inoxydable		88520	✓	29	1101	1,25/pc.
	 100 pc.						

	type	référence	 stock	page. catal.	groupe d'articles	prix en €
	Plaque de montage universelle					
	Acier galvanisé Sendzimir	8090109	✓	30	1122	6,72/pc.
	 10 pc.					
	Plaque de montage plane					
	Acier galvanisé Sendzimir	8250109	✓	30	1122	6,20/pc.
	 10 pc.					
	Plaque de montage emboutie					
	Acier galvanisé Sendzimir	8250209	✓	30	1122	7,29/pc.
	 10 pc.					
	Ressort de serrage rapide pour plaque de montage					
	Acier inoxydable	88540		30	1122	0,38/pc.
	 100 pc.					
	Bande de protection					
	Matière synthétique/acier	8040000	✓	30	1122	62,22/pc.
	L = 5 m					
	Fixation pour accessoire					
	Acier inoxydable	8856050	✓	31	1122	1,18/pc.
	 20 pc.					

	type	référence	🔍 stock	page. catal.	groupe d'articles	prix en €	
	Pièce d'angle, H = 60 mm						
	Acier galvanisé Sendzimir	70	36060702	✓	32	1122	25,11/pc.
		100	36061002	✓	32	1122	26,41/pc.
	Livrée sous forme aplanie.	120	36061202	✓	32	1122	26,99/pc.
		150	36061502	✓	32	1122	27,88/pc.
		200	36062002	✓	32	1122	29,94/pc.
		250	36062502	✓	32	1122	36,62/pc.
		300	36063002	✓	32	1122	44,30/pc.
		330	36063302	✓	32	1122	48,18/pc.
		400	36064002	✓	32	1122	57,23/pc.
		500	36065002		32	1122	72,32/pc.
		600	36066002		32	1122	92,18/pc.
		Pièce d'angle, H = 60 mm					
Acier galvanisé Sendzimir,		120	36061202UP9010N	-	1122	47,24/pc.	
laquage par poudrage blanc RAL 9010		200	36062002UP9010N	✓	-	1122	52,41/pc.
	330	36063302UP9010N	-	1122	84,31/pc.		
	Pièce d'angle, H = 60 mm						
	Acier galvanisé Sendzimir,	120	36061202UP9005N	✓	-	1122	47,24/pc.
	laquage par poudrage noir RAL 9005	200	36062002UP9005N	✓	-	1122	52,41/pc.
	330	36063302UP9005N	✓	-	1122	84,31/pc.	
	Couvercle pour pièce d'angle						
	Acier galvanisé Sendzimir	70	30060702	✓	32	1122	10,26/pc.
		100	30061002		32	1122	11,24/pc.
		120	30061202	✓	32	1122	12,30/pc.
		150	30061502		32	1122	14,64/pc.
		200	30062002	✓	32	1122	15,29/pc.
		250	30062502	✓	32	1122	17,98/pc.
		300	30063002		32	1122	24,96/pc.
		330	30063302		32	1122	25,74/pc.
		400	30064002		32	1122	33,43/pc.
		500	30065002		32	1122	46,68/pc.
	600	30066002		32	1122	67,71/pc.	
	Pièce d'angle réglable, H = 60 mm						
	Acier galvanisé Sendzimir	70	36520702		32	1122	25,83/pc.
		100	36521002	✓	32	1122	28,52/pc.
	Livrée sous forme aplanie.	120	36521202	✓	32	1122	29,21/pc.
		150	36521502		32	1122	30,20/pc.
		200	36522002	✓	32	1122	31,59/pc.
		250	36522502		32	1122	35,47/pc.
		300	36523002		32	1122	37,29/pc.
		330	36523302		32	1122	55,51/pc.
		400	36524002		32	1122	98,01/pc.
		500	36525002		32	1122	138,20/pc.
600		36526002		32	1122	161,60/pc.	



Pièce en T, H = 60 mm

	type	référence	stock	page. catal.	groupe d'articles	prix en €
Acier galvanisé Sendzimir	70	36150702	✓	32	1122	33,76/pc.
	100	36151002	✓	32	1122	36,58/pc.
Livrée sous forme aplanie.	120	36151202	✓	32	1122	38,62/pc.
	150	36151502	✓	32	1122	40,67/pc.
	200	36152002	✓	32	1122	44,47/pc.
	250	36152502	✓	32	1122	52,75/pc.
	300	36153002	✓	32	1122	61,02/pc.
	330	36153302		32	1122	68,20/pc.
	400	36154002		32	1122	85,05/pc.
	500	36155002		32	1122	96,02/pc.
	600	36156002		32	1122	116,85/pc.

Pièce en T, H = 60 mm

Acier galvanisé Sendzimir, laquage par poudrage blanc RAL 9010	120	36151202UP9010N	-	1122	67,57/pc.
	200	36152002UP9010N	-	1122	77,82/pc.
	330	36153302UP9010N	-	1122	119,36/pc.

Pièce en T, H = 60 mm

Acier galvanisé Sendzimir, laquage par poudrage noir RAL 9005	120	36151202UP9005N	-	1122	67,57/pc.
	200	36152002UP9005N	-	1122	77,82/pc.
	330	36153302UP9005N	-	1122	119,36/pc.

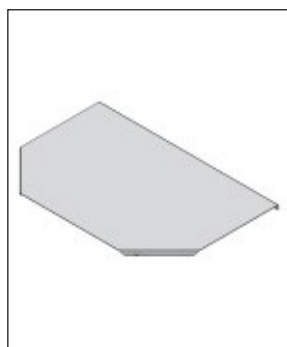

Couvercle pour pièce en T

Acier galvanisé Sendzimir	70	30150702	✓	33	1122	13,75/pc.
	100	30151002		33	1122	14,66/pc.
	120	30151202	✓	33	1122	16,08/pc.
	150	30151502		33	1122	16,48/pc.
	200	30152002	✓	33	1122	18,50/pc.
	250	30152502		33	1122	20,79/pc.
	300	30153002		33	1122	23,93/pc.
	330	30153302		33	1122	26,26/pc.
	400	30154002		33	1122	31,65/pc.
	500	30155002		33	1122	61,81/pc.
	600	30156002		33	1122	75,48/pc.



Croisillon, H = 60 mm

Acier galvanisé Sendzimir	70	36160702		33	1122	52,95/pc.
	100	36161002		33	1122	53,90/pc.
Livrée sous forme aplanie.	120	36161202	✓	33	1122	54,52/pc.
	150	36161502		33	1122	55,41/pc.
	200	36162002	✓	33	1122	57,47/pc.
	250	36162502		33	1122	67,27/pc.
	300	36163002		33	1122	74,15/pc.
	330	36163302		33	1122	97,39/pc.
	400	36164002		33	1122	110,75/pc.
	500	36165002		33	1122	130,55/pc.
	600	36166002		33	1122	159,99/pc.

Croisillon, H = 60 mm







Acier galvanisé Sendzimir, laquage par poudrage blanc RAL 9010	120	36161202UP9010N	-	1122	95,41/pc.
	200	36162002UP9010N	-	1122	100,58/pc.
	330	36163302UP9010N	-	1122	148,97/pc.



Croisillon, H = 60 mm

Acier galvanisé Sendzimir, laquage par poudrage noir RAL 9005	120	36161202UP9005N	-	1122	95,41/pc.
	200	36162002UP9005N	-	1122	100,58/pc.
	330	36163302UP9005N	-	1122	148,97/pc.

	type	référence	stock	page. catal.	groupe d'articles	prix en €	
	Couvercle pour croisillon						
	Acier galvanisé Sendzimir	70	30160702	33	1122	22,96/pc.	
		100	30161002	33	1122	24,87/pc.	
		120	30161202	33	1122	26,12/pc.	
		150	30161502	33	1122	27,15/pc.	
		200	30162002	33	1122	29,81/pc.	
		250	30162502	33	1122	33,06/pc.	
		300	30163002	33	1122	37,20/pc.	
		330	30163302	33	1122	40,31/pc.	
		400	30164002	33	1122	47,64/pc.	
	500	30165002	33	1122	57,20/pc.		
	600	30166002	33	1122	68,63/pc.		
	Dérivation, H = 60 mm						
	Acier galvanisé Sendzimir	70	36070702	✓	33	1122	17,86/pc.
		100	36071002	✓	33	1122	19,02/pc.
	Livrée sous forme aplanie.	120	36071202	✓	33	1122	19,45/pc.
		150	36071502		33	1122	19,88/pc.
		200	36072002	✓	33	1122	21,55/pc.
		250	36072502	✓	33	1122	24,59/pc.
		300	36073002	✓	33	1122	35,18/pc.
		330	36073302	✓	33	1122	41,86/pc.
		400	36074002		33	1122	48,57/pc.
		500	36075002		33	1122	63,37/pc.
		600	36076002		33	1122	63,68/pc.
		Dérivation, H = 60 mm					
Acier galvanisé Sendzimir, laquage par poudrage blanc RAL 9010		120	36071202UP9010N	-	1122	34,05/pc.	
		200	36072002UP9010N	✓	-	1122	37,70/pc.
	330	36073302UP9010N	-	1122	73,25/pc.		
	Dérivation, H = 60 mm						
	Acier galvanisé Sendzimir, laquage par poudrage noir RAL 9005	120	36071202UP9005N	✓	-	1122	34,05/pc.
		200	36072002UP9005N	✓	-	1122	37,70/pc.
	330	36073302UP9005N	✓	-	1122	73,25/pc.	
	Couvercle pour dérivation, H = 60 mm						
	Acier galvanisé Sendzimir	70	30070702	✓	34	1122	7,99/pc.
		100	30071002		34	1122	8,51/pc.
		120	30071202	✓	34	1122	10,09/pc.
		150	30071502		34	1122	11,65/pc.
		200	30072002	✓	34	1122	13,09/pc.
		250	30072502		34	1122	15,57/pc.
		300	30073002		34	1122	16,87/pc.
		330	30073302		34	1122	19,85/pc.
		400	30074002		34	1122	22,98/pc.
	500	30075002		34	1122	26,12/pc.	
	600	30076002		34	1122	32,21/pc.	
	Dérivation universelle, H = 60 mm						
	Acier galvanisé Sendzimir		36110002	✓	34	1122	7,73/pc.
	Livrée sous forme aplanie.						
	Couvercle pour dérivation universelle						
	Acier galvanisé Sendzimir		8980000	✓	34	1122	9,23/pc.

	type	référence	stock	page. catal.	groupe d'articles	prix en €	
	Dérivation surélevée, H = 60 mm						
	Acier galvanisé Sendzimir	70	36510702		35	1122	15,26/pc.
		100	36511002		35	1122	15,99/pc.
	Livrée sous forme aplanie.	120	36511202		35	1122	16,46/pc.
		150	36511502		35	1122	17,08/pc.
		200	36512002		35	1122	18,28/pc.
		250	36512502		35	1122	20,95/pc.
		300	36513002		35	1122	22,67/pc.
		330	36513302		35	1122	24,51/pc.
400		36514002		35	1122	29,74/pc.	
	Réduction, H = 60 mm						
	Acier galvanisé Sendzimir	70-120	36252202	✓	35	1122	21,97/pc.
		70-200	36252402		35	1122	28,89/pc.
	Livrée sous forme aplanie.	70-250	36252602		35	1122	29,89/pc.
		120-200	36254702	✓	35	1122	30,66/pc.
		120-250	36254802		35	1122	40,32/pc.
		200-250	36256402		35	1122	44,04/pc.
Couvercle pour réduction							
Acier galvanisé Sendzimir	70-120	30252202	✓	35	1122	9,74/pc.	
	70-200	30252402		35	1122	11,13/pc.	
	70-250	30252602		35	1122	13,97/pc.	
	120-200	30254702	✓	35	1122	12,61/pc.	
	120-250	30254802		35	1122	16,41/pc.	
	200-250	30256402		35	1122	16,76/pc.	
	Accouplement / réduction, H = 60 mm						
	Acier galvanisé Sendzimir	605	8940000	✓	36	1122	8,88/pc.
Pour jonctions angulaires jusqu'à 330 mm.							
	Accouplement / réduction, H = 60 mm						
	Acier galvanisé Sendzimir	957	8960000	✓	36	1122	13,68/pc.
Pour jonctions angulaires jusqu'à 600 mm.							
	Raccord de montée, H = 60 mm						
	Acier galvanisé Sendzimir	70	36230702	✓	36	1122	19,61/pc.
		100	36231002	✓	36	1122	21,55/pc.
	Livré sous forme aplanie.	120	36231202	✓	36	1122	23,68/pc.
		150	36231502	✓	36	1122	25,78/pc.
		200	36232002	✓	36	1122	28,38/pc.
		250	36232502	✓	36	1122	35,87/pc.
		300	36233002	✓	36	1122	45,26/pc.
		330	36233302	✓	36	1122	49,81/pc.
		400	36234002		36	1122	60,34/pc.
		500	36235002		36	1122	72,91/pc.
		600	36236002		36	1122	79,00/pc.
Raccord de montée, H = 60 mm							
Acier galvanisé Sendzimir, laquage par poudrage blanc RAL 9010	120	36231202UP9010N	-	1122	41,43/pc.		
	200	36232002UP9010N	-	1122	49,65/pc.		
	330	36233302UP9010N	-	1122	87,18/pc.		
Raccord de montée, H = 60 mm							
Acier galvanisé Sendzimir, laquage par poudrage noir RAL 9005	120	36231202UP9005N	-	1122	41,43/pc.		
	200	36232002UP9005N	-	1122	49,65/pc.		
	330	36233302UP9005N	-	1122	87,18/pc.		

	type	référence	stock	page. catal.	groupe d'articles	prix en €	
	Couvercle pour raccord de montée						
	Acier galvanisé Sendzimir	70	30230702	✓	36	1122	10,26/pc.
		100	30231002		36	1122	10,77/pc.
		120	30231202	✓	36	1122	11,92/pc.
		150	30231502		36	1122	13,88/pc.
		200	30232002		36	1122	15,29/pc.
		250	30232502		36	1122	19,31/pc.
		300	30233002		36	1122	22,96/pc.
		330	30233302		36	1122	23,93/pc.
		400	30234002		36	1122	30,20/pc.
		500	30235002		36	1122	36,09/pc.
	600	30236002		36	1122	46,37/pc.	
	Raccord de descente, H = 60 mm						
	Acier galvanisé Sendzimir	70	36220702	✓	37	1122	19,61/pc.
		100	36221002	✓	37	1122	21,55/pc.
	Livré sous forme aplanie.	120	36221202	✓	37	1122	23,68/pc.
		150	36221502	✓	37	1122	25,78/pc.
		200	36222002	✓	37	1122	28,38/pc.
		250	36222502	✓	37	1122	35,87/pc.
		300	36223002	✓	37	1122	45,26/pc.
		330	36223302		37	1122	49,81/pc.
		400	36224002		37	1122	60,34/pc.
		500	36225002		37	1122	72,91/pc.
	600	36226002		37	1122	79,00/pc.	
	Raccord de descente, H = 60 mm						
	Acier galvanisé Sendzimir,	120	36221202UP9010N	-	1122	41,43/pc.	
	laquage par poudrage blanc RAL 9010	200	36222002UP9010N	-	1122	49,65/pc.	
	330	36223302UP9010N	-	1122	87,18/pc.		
	Raccord de descente, H = 60 mm						
	Acier galvanisé Sendzimir,	120	36221202UP9005N	-	1122	41,43/pc.	
	laquage par poudrage noir RAL 9005	200	36222002UP9005N	-	1122	49,65/pc.	
	330	36223302UP9005N	-	1122	87,18/pc.		
	Couvercle pour raccord de descente, H = 60 mm						
	Acier galvanisé Sendzimir	70	30220702	✓	37	1122	10,26/pc.
		100	30221002		37	1122	11,00/pc.
		120	30221202	✓	37	1122	11,92/pc.
		150	30221502		37	1122	13,35/pc.
		200	30222002	✓	37	1122	15,29/pc.
		250	30222502		37	1122	19,31/pc.
		300	30223002		37	1122	21,67/pc.
		330	30223302		37	1122	23,93/pc.
		400	30224002		37	1122	30,20/pc.
		500	30225002		37	1122	36,09/pc.
	600	30226002		37	1122	46,37/pc.	
	Pièce en T verticale terminale, H = 60 mm						
	Acier galvanisé Sendzimir	70	36430702		37	1122	39,66/pc.
		100	36431002		37	1122	40,44/pc.
	Livrée sous forme aplanie.	120	36431202	✓	37	1122	40,95/pc.
		150	36431502		37	1122	50,09/pc.
	Pour la pièce en T verticale	200	36432002		37	1122	51,15/pc.
	affichée, 2 pièces en	250	36432502		37	1122	55,09/pc.
	T verticales terminales	300	36433002		37	1122	55,50/pc.
	doivent être commandées.	330	36433302		37	1122	56,05/pc.
		400	36434002		37	1122	61,16/pc.
		500	36435002		37	1122	66,93/pc.
	600	36436002		37	1122	69,81/pc.	

	type	référence	🔍 stock	page. catal.	groupe d'articles	prix en €	
	Pièce murale verticale avec couvercle, H = 60 mm						
	Acier galvanisé Sendzimir	70	36240702	✓	38	1122	65,35/pc.
		100	36241002		38	1122	65,68/pc.
	Avec couvercle.	120	36241202	✓	38	1122	68,43/pc.
	Livrée sous forme aplanie.	150	36241502		38	1122	71,07/pc.
		200	36242002		38	1122	74,52/pc.
		250	36242502		38	1122	85,80/pc.
		300	36243002		38	1122	98,19/pc.
		330	36243302		38	1122	109,90/pc.
		400	36244002		38	1122	120,30/pc.
		500	36245002		38	1122	163,02/pc.
	600	36246002		38	1122	199,71/pc.	
	Cloison terminale, H = 60 mm						
	Acier galvanisé Sendzimir	70	36180704	✓	38	1122	5,97/pc.
		100	36181004		38	1122	6,28/pc.
	Livrée sous forme aplanie.	120	36181204	✓	38	1122	6,71/pc.
		150	36181504		38	1122	7,19/pc.
		200	36182004	✓	38	1122	7,49/pc.
		250	36182504		38	1122	8,07/pc.
		300	36183004		38	1122	9,17/pc.
		330	36183304		38	1122	9,83/pc.
		400	36184004		38	1122	10,65/pc.
		500	36185004		38	1122	12,69/pc.
		600	36186004		38	1122	14,79/pc.
	Cloison terminale, H = 60 mm						
Acier galvanisé Sendzimir,	120	36181204UP9010N	-	1122	11,73/pc.		
laquage par poudrage	200	36182004UP9010N	-	1122	13,11/pc.		
blanc RAL 9010	330	36183304UP9010N	-	1122	17,19/pc.		
Cloison terminale, H = 60 mm							
Acier galvanisé Sendzimir,	120	36181204UP9005N	-	1122	11,73/pc.		
laquage par poudrage	200	36182004UP9005N	-	1122	13,11/pc.		
noir RAL 9005	330	36183304UP9005N	-	1122	17,19/pc.		





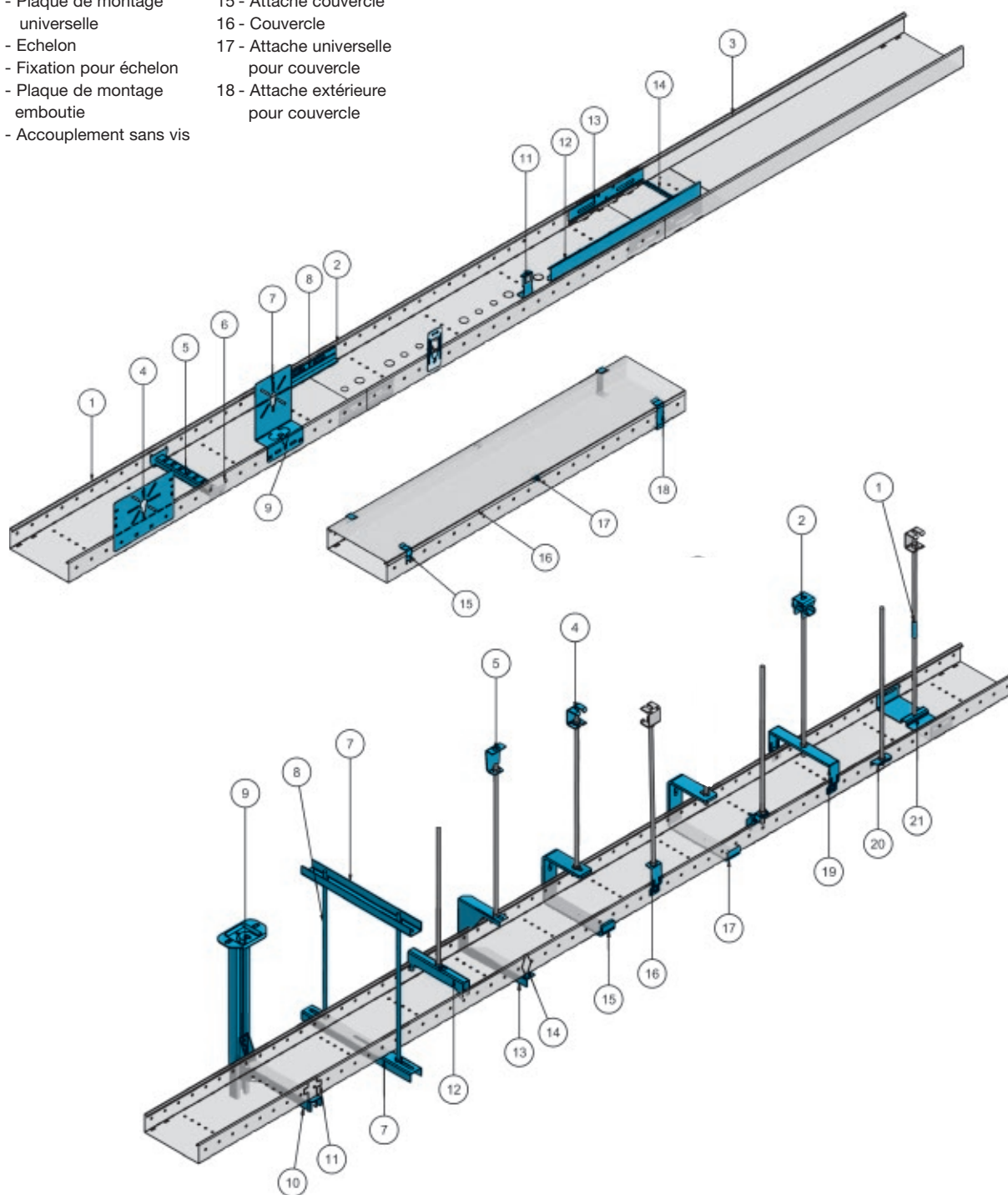

Vue d'ensemble

- | | |
|---|---|
| 1 - Gaine à câbles à parois latérales perforées | 9 - Fixation pour accessoire |
| 2 - Gaine à câbles avec opercules défonçables | 11 - Dispositif de verrouillage |
| 3 - Gaine à câbles non perforées | 12 - Cloison de séparation |
| 4 - Plaque de montage universelle | 13 - Accouplement |
| 5 - Echelon | 14 - Etrier de fond |
| 6 - Fixation pour échelon | 15 - Attache couvercle |
| 7 - Plaque de montage emboutie | 16 - Couvercle |
| 8 - Accouplement sans vis | 17 - Attache universelle pour couvercle |
| | 18 - Attache extérieure pour couvercle |





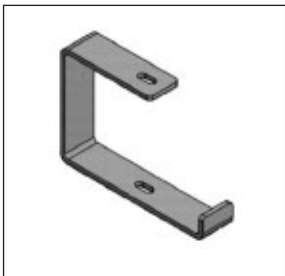



- | | | |
|------------------------------|----------------------------|---|
| 1 - Ecrou de rallonge | 10 - Console 50i | |
| 2 - Etrier de plafond | 11 - Ressort | |
| 4 - Etrier de plafond ouvert | 12 - Etrier supérieur | |
| 5 - Etrier de plafond | 13 - Etrier en C extérieur | 19 - Etrier supérieur pour porteur de câbles avec couvercle |
| 7 - Profilé de support | 14 - Ressort | 20 - Etrier pour perforation latérale |
| 8 - Tige filetée M10 | 15 - Etrier en C | 21 - Etrier intérieur |
| 9 - Pendard 2F | 16 - Etrier de suspension | |
| | 17 - Etrier en C | |

Systemes de suspension – gaines et chemins de câbles

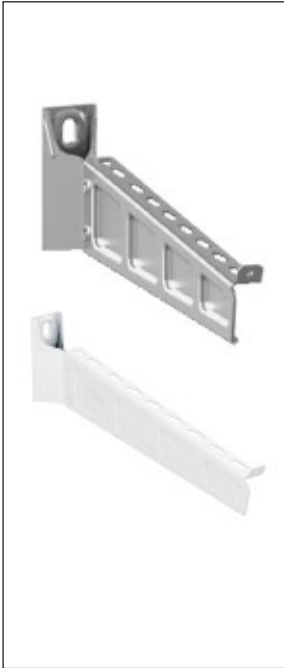
	type	référence	stock	page. catal.	groupe d'articles	prix en €	
	Etrier supérieur						
	Acier galvanisé Sendzimir	70	8101009	✓	49	1127	4,37/pc.
	 30 pc.	120	8112009	✓	49	1127	5,29/pc.
	 20 pc.	200	8123009		49	1127	7,52/pc.
		250	8134009		49	1127	8,51/pc.
	330	8135009		49	1127	11,22/pc.	
	Etrier supérieur						
	Acier galvanisé Sendzimir	70	86510		49	1127	13,45/pc.
	 25 pc.	120	86520		49	1127	15,80/pc.
	 10 pc.	200	86530		49	1127	17,84/pc.
250		86540		49	1127	19,31/pc.	
	Etrier intérieur avec écrou M10						
	Acier galvanisé Sendzimir	70	8140709	✓	49	1127	7,42/pc.
	 5 pc.	100	8141009	✓	49	1127	8,31/pc.
		120	8141209	✓	49	1127	9,07/pc.
		150	8141509	✓	49	1127	9,89/pc.
		200	8142009	✓	49	1127	10,99/pc.
		250	8142509	✓	49	1127	13,03/pc.
		300	8143009	✓	49	1127	14,62/pc.
330		8143309	✓	49	1127	15,76/pc.	
	Etrier en C extérieur						
	Acier galvanisé Sendzimir	70	81710	✓	50	1127	15,46/pc.
	 10 pc.	120	81720	✓	50	1127	16,97/pc.
		200	81730	✓	50	1127	22,98/pc.
		250	81740		50	1127	27,45/pc.
Deux pièces ressorts 84400 à commander séparément.							
	Ressort						
	Acier inoxydable		84400		50	1127	1,50/pc.
 25 pc.							
	Etrier en C						
	Acier galvanisé Sendzimir	70	CEZ070	✓	50	1504	7,74/pc.
	 10 pc.	100	CEZ100	✓	50	1504	8,30/pc.
		120	CEZ120	✓	50	1504	8,66/pc.
		150	CEZ150	✓	50	1504	11,91/pc.
	 6 pc.	200	CEZ200	✓	50	1504	13,25/pc.
		300	CEZ300	✓	50	1504	20,45/pc.
		400	CEZ400	✓	50	1504	26,74/pc.
	Etrier en C						
	Acier galvanisé à chaud	70	81712	✓		1127	11,22/pc.
	 20 pc.	100	81731	✓		1127	11,95/pc.
		120	81722	✓		1127	13,49/pc.
		150	81715	✓		1127	15,80/pc.
		200	81732	✓		1127	17,46/pc.
	 15 pc.	250	81742	✓		1127	23,59/pc.
		300	81733	✓		1127	26,15/pc.
		330	81752	✓		1127	30,81/pc.
	 10 pc.	400	81762	✓		1127	39,29/pc.

Systemes de suspension – gaines et chemins de câbles

	type	référence	📦 stock	page. catal.	groupe d'articles	prix en €	
	Pendant simple 2F						
	Acier galvanisé à chaud	2F/ 280	717196	✓	51	1313	22,18/pc.
		2F/ 370	717197	✓	51	1313	25,34/pc.
		2F/ 505	717198	✓	51	1313	28,77/pc.
		2F/ 730	717199	✓	51	1313	33,02/pc.
		2F/ 1000	717200	✓	51	1313	37,93/pc.
	2F/ 1500	787276	✓	51	1313	110,14/pc.	
	Pendant double 20						
	Acier galvanisé à chaud	20/ 505	715723	✓	51	1313	68,89/pc.
		20/ 730	715724	✓	51	1313	83,79/pc.
		20/ 1000	715725	✓	51	1313	106,12/pc.
		20/ 1500	715726	✓	51	1313	138,52/pc.
		20/ 2000	715727	✓	51	1313	174,04/pc.
	20/ 3000	715728	✓	51	1313	288,19/pc.	
	Console 50i						
	Acier galvanisé Sendzimir	50i/ 100	791412	✓	52	1304	4,38/pc.
		50i/ 200	791413	✓	52	1304	6,10/pc.
		50i/ 300	791414	✓	52	1304	7,41/pc.
		50i/ 400	791415	✓	52	1304	11,99/pc.
		50i/ 500	795322	✓		1304	18,65/pc.
		50i/ 600	795323	✓		1304	21,18/pc.
	Console 50i						
	Acier galvanisé à chaud	50i/ 100	795316	✓		1304	7,95/pc.
		50i/ 200	795317	✓		1304	8,98/pc.
		50i/ 300	795318	✓		1304	13,15/pc.
		50i/ 400	795319	✓		1304	14,93/pc.
		50i/ 500	795320	✓		1304	20,34/pc.
		50i/ 600	795321	✓		1304	22,96/pc.
	Console 50i						
	Acier galvanisé Sendzimir, laquage par poudrage blanc RAL 9010	50i/ 100	791416			1304	20,59/pc.
		50i/ 200	791417			1304	25,57/pc.
		50i/ 300	791418			1304	29,28/pc.
		50i/ 400	791419			1304	45,33/pc.
		50i/ 500	795363			1304	50,27/pc.
		50i/ 600	795364			1304	54,69/pc.
	Console murale ou plaque murale						
	Acier galvanisé Sendzimir	70	80610	✓	53	1127	11,92/pc.
	📦 20 pc.						
	Deux ressorts 84901 à commander séparément.						
	Profilé de suspension pour console						
	Acier galvanisé Sendzimir	100	40611		53	1127	2,45/pc.
		120	80602	✓	53	1127	2,77/pc.
		150	40616		53	1127	3,28/pc.
		200	80603	✓	53	1127	4,49/pc.
	Apte à ressort 84901.	250	80604	✓	53	1127	5,49/pc.
		300	40631	✓	53	1127	7,09/pc.
		330	80605		53	1127	9,17/pc.
		400	80606	✓	53	1127	11,62/pc.
		500	80607		53	1127	18,03/pc.

Systemes de suspension – gaines et chemins de câbles

	type	référence	stock	page. catal.	groupe d'articles	prix en €	
	Ressort						
	Acier inoxydable	84901	✓		1127	1,83/pc.	
	 25 pc.						
	Deux pièces par profilé de suspension.						
	Etrier de serrage						
	Acier galvanisé Sendzimir	M10	81501	53	1127	3,28/pc.	
	 50 pc.						
	Etrier de serrage						
	Acier galvanisé Sendzimir	M10	81503	52	1127	4,00/pc.	
	 50 pc.						
	Etrier de plafond						
	Acier galvanisé Sendzimir	M10	80200	✓	52	1127	4,37/pc.
	Etrier de plafond, ouvert						
	Acier galvanisé à chaud	M10	80202	✓	53	1127	3,59/pc.
	Etrier de plafond, réglable						
	Acier galvanisé à chaud	M10	80201	✓	53	1127	8,42/pc.
	Equerre W8						
	Acier galvanisé Sendzimir	W8	716821	✓	49	1306	5,04/pc.
	 10 pc.						
	Equerre W8						
	Acier galvanisé à chaud	W8	728883	49	1306	8,46/pc.	
	 10 pc.						

Systemes de suspension – gaines et chemins de cables

	type	référence	stock	page. catal.	groupe d'articles	prix en €	
	Vis crnelée						
	Acier à zingage électrolytique	M6x10	08462000	✓	57	1127	0,22/pc.
	 100 pc.						
	Vis crnelée						
	Acier galvanisé à chaud	M6x10	08462020	✓		1127	0,24/pc.
	 100 pc.						
	Ecro 6 pans à embase crnelée						
	Acier à zingage électrolytique	M6	08461000	✓	57	1127	0,20/pc.
	 100 pc.	M10	08890100			1127	0,57/pc.
	Ecro 6 pans à embase crnelée						
	Acier galvanisé à chaud	M6	08461020	✓		1127	0,25/pc.
	 100 pc.						
	Ecro hexagonal						
	Acier à zingage électrolytique	M6	08180000	✓	57	1127	0,15/pc.
		M8	08891000	✓	57	1127	0,17/pc.
	 100 pc.	M10	08890000	✓	57	1127	0,20/pc.
	Rondelle						
	Acier à zingage électrolytique	M6	08190000	✓	57	1127	0,05/pc.
		M8	08901000	✓	57	1127	0,08/pc.
	 100 pc.	M10	08900000	✓	57	1127	0,20/pc.
	Rondelle						
	Acier galvanisé à chaud	M6	08190020			1127	0,20/pc.
	 100 pc.						
	Rondelle carrosserie						
	Acier à zingage électrolytique	M6	81977	✓	57	1127	0,08/pc.
		M8	89077	✓	57	1127	0,15/pc.
	 200 pc.	M10	89177	✓	57	1127	0,23/pc.
	Tige filetée						
	Acier à zingage électrolytique	M6	08050200	✓	58	1127	2,71/m
		M8	08051000	✓	58	1127	4,10/m
	 50 m ↔ 2 m	M10	08050000	✓	58	1127	4,87/m
	Tige filetée						
	Acier à zingage électrolytique	M10	08050100	✓		1127	4,87/m
	 50 m ↔ 3 m						
	Tige filetée						
	Acier galvanisé à chaud	M10	08051020			1127	16,09/m
	 50 m ↔ 1 m						
	Ecro de rallonge hexagonal						
	Acier à zingage électrolytique	M8x24	725083		58	1313	3,57/pc.
	 10 pc.	M10x30	724806	✓	58	1313	4,98/pc.

gaines à câbles
fermées **inducanal**®

chemins de câbles
perforés **pemsaband**®

inducanal® gaines à câbles fermées

pemsaband® chemins de câbles perforés

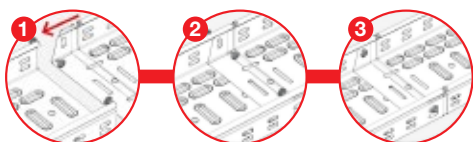

Système de raccordement Click

Le système de raccordement unique est pourvu de languettes, ce qui augmente la facilité de raccordement des longueurs et réduit considérablement la durée d'installation. Ainsi, les plaques d'accouplement deviennent superflues lors du montage de tracés droits. Deux boulons à collet et écrous à embase crénelée suffisent pour fixer le raccordement.

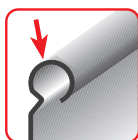

Sûr

Le rebord de sécurité offre une rigidité supplémentaire et permet d'éviter les blessures et l'endommagement du câblage.

Rebord fini

Grâce au rebord fini un couvercle PEMSA approprié peut être encliqueté sans matériel de fixation supplémentaire. Même dans le cas d'un montage vertical, le couvercle reste en place.



Rigide

La base profilée augmente considérablement la résistance

longitudinale et transversale. Les chemins de câbles et gaines à câbles en deviennent extrêmement solides avec une capacité élevée en comparaison d'un chemin de câbles sans relief.



Pemsaband LX & SX avec double rangée de perforations

Cela permet d'attacher les câbles au parois latérales d'une manière encore plus efficace et plus simple.

pemsaband®**inducanal**®click **SX**click **LX****INOX**

click fermé

INOX fermé**Caractéristiques**

G.S.	✓	✓		✓	
H.D.	✓	✓		✓	
INOX 304			✓		✓
mm	100-600	100-600	100-600	60-600	60-600
mm	60/85 (click) 100 (non-click)	35/60/85 (click) 100 (non-click)	60	35/60/85 (click) 100 (non-click)	60
L mm	3000	3000	3000	3000	3000
	-50 °C / +150 °C				
N/m					
	20 J.				
	E60				

Applications

Tertiaire	✓	✓		✓	
Tunnels	✓	✓		✓	
Centres de données	✓	✓		✓	
Installations PV	✓	✓			
Industrie alimentaire	✓	✓	✓	✓	✓
Pétrochimie	✓	✓	✓	✓	✓
G.S.	page 59	page 59	-	page 60	-
H.D.	page 67	page 67	-	page 68	-
INOX 304	-	-	page 75	-	page 75

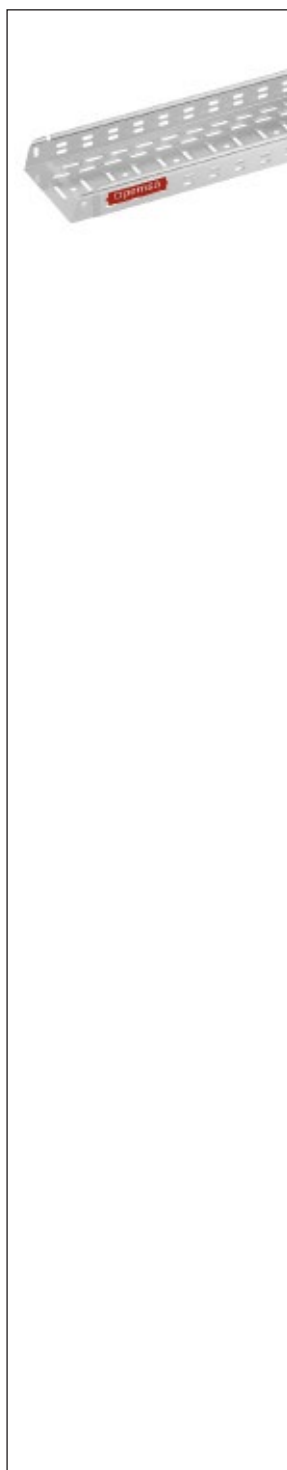

G.S. galvanisation Sendzimir NBN EN 10346 – recommandé dans les environnements corrosifs C2 (faible)
H.D. galvanisation à chaud NBN EN ISO 1461 – recommandé dans les environnements corrosifs C3/C4 (moyen/haut)
INOX 304 acier inoxydable AISI 304 – recommandé dans les environnements corrosifs C5-I (très haut – industrie)

voir page 2





Chemin de câbles Pemsaband LX Click, H = 35 mm

Acier galvanisé Sendzimir

type	référence	stock	page. catal.	groupe d'articles	prix en €
↔ 3 m  24 m	35x100 75821100	✓	8	2308	8,32/m
 12 m	35x150 75821150	✓	8	2308	10,34/m
	35x200 75821200	✓	8	2308	13,68/m
	35x300 75821300	✓	8	2308	18,12/m



Chemin de câbles Pemsaband LX Click, H = 60 mm

Acier galvanisé Sendzimir

↔ 3 m  24 m	60x100 75822100	✓		2310	8,77/m
 12 m	60x150 75822150	✓		2310	11,56/m
	60x200 75822200	✓		2310	13,07/m
 6 m	60x300 75822300	✓		2310	17,02/m
	60x400 75822400	✓		2310	21,29/m
	60x500 75822500	✓		2310	29,86/m
	60x600 75822600	✓		2310	34,97/m

Chemin de câbles Pemsaband SX Click, H = 60 mm

Acier galvanisé Sendzimir

↔ 3 m  24 m	60x100 75522100	✓	8	2308	10,16/m
 12 m	60x150 75522150	✓	8	2308	13,57/m
	60x200 75522200	✓	8	2308	14,71/m
 6 m	60x300 75522300	✓	8	2308	19,58/m
	60x400 75522400	✓	8	2308	28,29/m
	60x500 75522500	✓	8	2308	33,21/m
	60x600 75522600	✓	8	2308	38,99/m

Chemin de câbles Pemsaband LX Click, H = 85 mm

Acier galvanisé Sendzimir

↔ 3 m	85x200 75223200		8	2308	19,21/m
	85x300 75223300		8	2308	24,27/m
	85x400 75223400		8	2308	35,77/m
	85x500 75223500		8	2308	42,09/m
	85x600 75223600		8	2308	49,57/m

Chemin de câbles Pemsaband LX, H = 100 mm

Acier galvanisé Sendzimir

↔ 3 m	100x200 75224200		8	2308	20,68/m
	100x300 75224300		8	2308	25,74/m
	100x400 75224400		8	2308	38,13/m
	100x500 75224500		8	2308	43,90/m
	100x600 75224600		8	2308	52,55/m

Accouplement Reijband-Pemsaband

Acier galvanisé Sendzimir



 1 set	60	70120200		20	2309	21,40/set
---	----	----------	--	----	------	-----------







Gaine à câbles Inducanal Click, H= 35 mm

Acier galvanisé Sendzimir

	type	référence	stock	page. catal.	groupe d'articles	prix en €
↔ 3 m	 24 m	35x100	75121100	8	2311	8,32/m
		35x150	75121150	8	2311	10,34/m
	 12 m	35x200	75121200	8	2311	13,68/m
		35x300	75121300	8	2311	18,12/m

Gaine à câbles Inducanal Click, H= 60 mm

Acier galvanisé Sendzimir

↔ 3 m	 24 m	60x060	75122060	✓	8	2311	10,16/m
		60x100	75122100	✓	8	2311	10,16/m
	 12 m	60x150	75122150	✓	8	2311	13,57/m
		60x200	75122200	✓	8	2311	14,71/m
 6 m		60x300	75122300	✓	8	2311	19,58/m
		60x400	75122400	8	2311	28,29/m	
		60x500	75122500	8	2311	33,21/m	
		60x600	75122600	8	2311	52,73/m	

Gaine à câbles Inducanal Click, H= 85 mm

Acier galvanisé Sendzimir

↔ 3 m	85x200	75423200	8	2311	21,85/m
	85x300	75423300	8	2311	29,01/m
	85x400	75423400	8	2311	41,24/m
	85x500	75423500	8	2311	48,04/m
	85x600	75423600	8	2311	54,31/m

Gaine à câbles Inducanal, H = 100 mm

Acier galvanisé Sendzimir

↔ 3 m	100x200	75424200	8	2311	23,53/m
	100x300	75424300	8	2311	31,32/m
	100x400	75424400	8	2311	43,36/m
	100x500	75424500	8	2311	49,99/m
	100x600	75424600	8	2311	66,72/m

Boulon à collet carré et écrou 6 pans à embase crénelée

Acier à zingage électrolytique

 100 pc.

M6X12	67010093	✓	2309	0,35/pc.
-------	----------	---	------	----------

Boulon à collet carré

Acier à zingage électrolytique

 100 pc.

M6x12	67010099	✓	2309	0,26/pc.	
M6x20	67010100	✓	9	2309	0,29/pc.







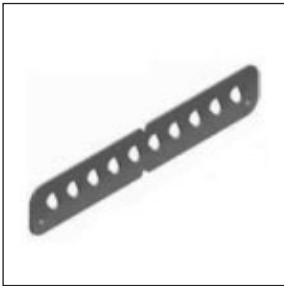
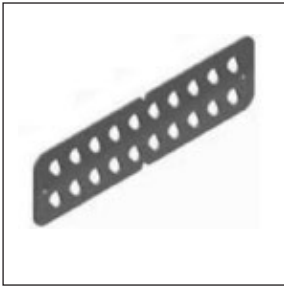

Écrou 6 pans à embase crénelée

Acier à zingage électrolytique

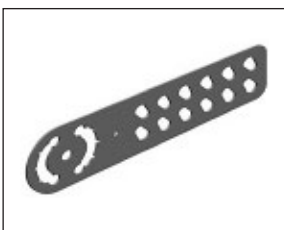

 50 pc.

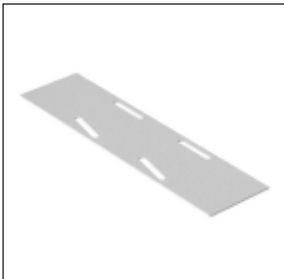

M6	64010059	✓	9	2309	0,20/pc.
----	----------	---	---	------	----------





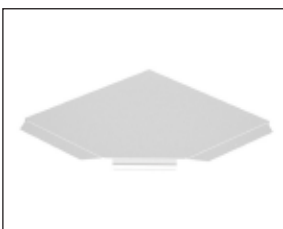



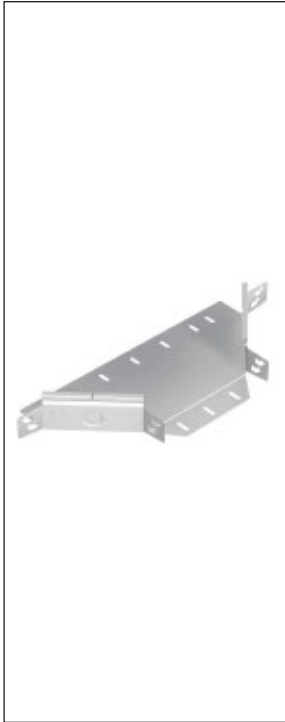

	type	référence	📦 stock	page. catal.	groupe d'articles	prix en €
	Accouplement					
	Acier galvanisé Sendzimir	35	71021005	✓	9	2309 1,46/pc.
	Accouplement					
	Acier galvanisé Sendzimir	60	93910002	✓		2309 2,13/pc.
	Accouplement					
	Acier galvanisé Sendzimir	85/100	93910003			2309 3,84/pc.
	Plaque pour pièce de montée/descente					
	Acier galvanisé Sendzimir	35	71021006	✓	10	2309 1,21/pc.
			 4 pc.			
			4 plaques pour 1 pièce de montée/descente.			
	Plaque pour pièce de montée/descente					
	Acier galvanisé Sendzimir	60	93910012	✓		2309 2,25/pc.
			 8 pc.			
			4 plaques pour 1 pièce de montée/descente.			
	Plaque pour pièce de montée/descente					
	Acier galvanisé Sendzimir	85/100	93910013		10	2309 3,79/pc.
			 8 pc.			
			4 plaques pour 1 pièce de montée/descente.			
	Accouplement de fond					
	Acier galvanisé Sendzimir	300	71020300		9	2309 8,22/pc.
		400	71020400		9	2309 9,54/pc.
		500	71020500		9	2309 10,70/pc.
		600	71020600		9	2309 12,90/pc.
			 10 pc.			

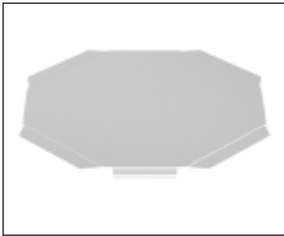
	type	référence	stock	page. catal.	groupe d'articles	prix en €		
	Plaque de montage Pemsaband							
	Acier galvanisé Sendzimir	60	70420911	✓	15	2309	6,14/pc.	
	 10 pc.							
	Bande de protection							
	Caoutchouc/adhésif		71000000	✓	15	2309	7,00/m	
	 25 m							
	Borne de terre							
	Cuivre	16-50 mm ²	68000034	✓	15	2309	5,95/pc.	
	 20 pc.							
	Couvercle Click							
	Acier galvanisé Sendzimir							
	↔ 3 m	 24 m	60	73021060	✓	8	2316	7,08/m
			100	73021100	✓	8	2316	9,14/m
		 12 m	150	73021150	✓	8	2316	11,84/m
			200	73021200	✓	8	2316	14,42/m
		 6 m	300	73021300	✓	8	2316	21,99/m
			400	73021400		8	2316	28,17/m
		500	73021500		8	2316	38,16/m	
		600	73021600		8	2316	44,78/m	
	Cloison de séparation							
	Acier galvanisé Sendzimir							
	↔ 3 m	 60 m	25	67020610	✓	10	2316	7,05/m
		 48 m	50	67020611	✓	10	2316	7,92/m
	 36 m	80	67020612		10	2316	13,93/m	
	Plaque d'identification							
	Matière synthétique		68000020		10	2307	1,17/pc.	
	 50 pc.							

	type	référence	🔍 stock	page. catal.	groupe d'articles	prix en €
	Courbe réglable					
	Acier galvanisé Sendzimir	35x100	70028110		14 2309	36,24/pc.
		35x150	70028115		14 2309	38,21/pc.
	Livrée sous forme aplanie.	35x200	70028120		14 2309	44,51/pc.
		35x300	70028130		14 2309	49,94/pc.
		60x100	70028210	✓	14 2309	36,80/pc.
		60x150	70028215		14 2309	39,05/pc.
	60x200	70028220	✓	14 2309	45,26/pc.	
	60x300	70028230	✓	14 2309	51,03/pc.	
	Embout et réduction					
	Acier galvanisé Sendzimir	35x100	71021010		14 2309	23,00/pc.
		35x150	71021015		14 2309	29,69/pc.
	Livrée sous forme aplanie.	35x200	71021020		14 2309	31,57/pc.
		35x300	71021030		14 2309	42,63/pc.
		60x100	71022010	✓	14 2309	24,45/pc.
		60x150	71022015		14 2309	31,98/pc.
	60x200	71022020		14 2309	36,08/pc.	
	60x300	71022030		14 2309	47,08/pc.	
	Courbe Click 90°					
	Acier galvanisé Sendzimir	35x100	70020110		11 2309	25,54/pc.
		35x150	70020115		11 2309	28,52/pc.
	Livrée sous forme aplanie.	35x200	70020120		11 2309	32,66/pc.
		35x300	70020130		11 2309	37,90/pc.
		60x060	70020206		11 2309	24,38/pc.
		60x100	70020210	✓	11 2309	24,38/pc.
		60x150	70020215	✓	11 2309	26,16/pc.
		60x200	70020220	✓	11 2309	28,08/pc.
		60x300	70020230	✓	11 2309	41,55/pc.
		60x400	70020240	✓	11 2309	53,68/pc.
		60x500	70020250	✓	11 2309	61,88/pc.
		60x600	70020260	✓	11 2309	81,09/pc.
		85x200	70020320		11 2309	38,37/pc.
		85x300	70020330		11 2309	49,52/pc.
	85x400	70020340		11 2309	107,54/pc.	
	85x500	70020350		11 2309	130,58/pc.	
	85x600	70020360		11 2309	134,78/pc.	
	100x200	70020420		11 2309	54,80/pc.	
	100x300	70020430		11 2309	83,14/pc.	
	100x400	70020440		11 2309	116,24/pc.	
	100x500	70020450		11 2309	146,23/pc.	
	100x600	70020460		11 2309	170,55/pc.	
	Couvercle pour courbe Click 90°					
	Acier galvanisé Sendzimir	60	73020060		11 2309	21,29/pc.
		100	73020100	✓	11 2309	21,29/pc.
		150	73020150	✓	11 2309	24,33/pc.
		200	73020200	✓	11 2309	27,25/pc.
		300	73020300		11 2309	36,24/pc.
		400	73020400		11 2309	66,84/pc.
		500	73020500		11 2309	84,18/pc.
	600	73020600		11 2309	96,16/pc.	

	type	référence	🌀 stock	page. catal.	groupe d'articles	prix en €	
	Pièce en T Click						
	Acier galvanisé Sendzimir	35x100	70022110		11	2309	33,81/pc.
		35x150	70022115		11	2309	37,77/pc.
	Livrée sous forme aplanie.	35x200	70022120		11	2309	43,30/pc.
		35x300	70022130		11	2309	50,17/pc.
		60x100	70022210	✓	11	2309	35,22/pc.
		60x150	70022215	✓	11	2309	39,47/pc.
		60x200	70022220	✓	11	2309	45,12/pc.
		60x300	70022230	✓	11	2309	52,12/pc.
		60x400	70022240		11	2309	97,07/pc.
		60x500	70022250		11	2309	139,35/pc.
		60x600	70022260		11	2309	159,25/pc.
		85x200	70022320		11	2309	50,79/pc.
		85x300	70022330		11	2309	65,33/pc.
		85x400	70022340		11	2309	116,16/pc.
	85x500	70022350		11	2309	135,88/pc.	
	85x600	70022360		11	2309	172,80/pc.	
	Couvercle pour pièce en T Click						
	Acier galvanisé Sendzimir	100	73022100		11	2309	28,23/pc.
		150	73022150		11	2309	31,57/pc.
		200	73022200		11	2309	36,08/pc.
		300	73022300		11	2309	51,76/pc.
		400	73022400		11	2309	76,75/pc.
		500	73022500		11	2309	110,28/pc.
600		73022600		11	2309	125,95/pc.	
	Pièce murale verticale						
	Acier galvanisé Sendzimir	60x100	70027100		20	2309	14,79/pc.
		60x150	70027150		20	2309	16,79/pc.
	Livrée sous forme aplanie.						
	Dérivation Click						
	Acier galvanisé Sendzimir	35x100	70023110		12	2309	25,35/pc.
		35x150	70023115		12	2309	28,23/pc.
	Livrée sous forme aplanie.	35x200	70023120		12	2309	32,91/pc.
		35x300	70023130		12	2309	37,52/pc.
		60x060	70023206		12	2309	20,91/pc.
		60x100	70023210	✓	12	2309	20,91/pc.
		60x150	70023215	✓	12	2309	21,85/pc.
		60x200	70023220	✓	12	2309	23,68/pc.
		60x300	70023230	✓	12	2309	36,74/pc.
		60x400	70023240	✓	12	2309	52,88/pc.
		60x500	70023250		12	2309	60,54/pc.
		60x600	70023260		12	2309	63,96/pc.
		85x200	70023320		12	2309	39,84/pc.
		85x300	70023330		12	2309	45,86/pc.
		85x400	70023340		12	2309	53,95/pc.
		85x500	70023350		12	2309	58,57/pc.
		85x600	70023360		12	2309	59,80/pc.
		100x200	70023420		12	2309	45,63/pc.
	100x300	70023430		12	2309	49,52/pc.	
	100x400	70023440		12	2309	60,10/pc.	
	100x500	70023450		12	2309	66,49/pc.	
	100x600	70023460		12	2309	69,14/pc.	

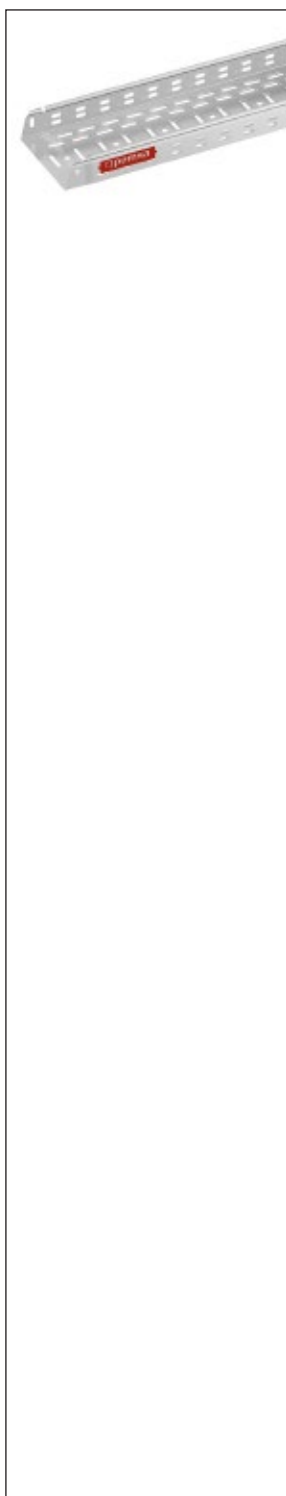

	type	référence	🌀 stock	page. catal.	groupe d'articles	prix en €	
	Couvercle pour dérivation Click						
	Acier galvanisé Sendzimir	60	73023060		12	2309	21,54/pc.
		100	73023100		12	2309	21,54/pc.
		150	73023150		12	2309	21,85/pc.
		200	73023200		12	2309	22,93/pc.
		300	73023300		12	2309	29,61/pc.
		400	73023400		12	2309	30,89/pc.
		500	73023500		12	2309	37,60/pc.
	600	73023600		12	2309	38,92/pc.	
	Croisillon Click						
	Acier galvanisé Sendzimir	35x100	70024110		12	2309	36,98/pc.
		35x150	70024115		12	2309	39,90/pc.
	Livrée sous forme aplanie.	35x200	70024120		12	2309	46,22/pc.
		35x300	70024130		12	2309	54,80/pc.
		60x100	70024210		12	2309	37,95/pc.
		60x150	70024215		12	2309	38,44/pc.
		60x200	70024220	✓	12	2309	44,51/pc.
		60x300	70024230	✓	12	2309	54,31/pc.
		60x400	70024240		12	2309	61,80/pc.
		60x500	70024250		12	2309	115,45/pc.
		60x600	70024260		12	2309	159,10/pc.
		85x200	70024320		12	2309	51,58/pc.
		85x300	70024330		12	2309	62,83/pc.
		85x400	70024340		12	2309	71,66/pc.
		85x500	70024350		12	2309	130,03/pc.
	85x600	70024360		12	2309	179,18/pc.	
	Couvercle pour croisillon Click						
	Acier galvanisé Sendzimir	100	73024100		12	2309	31,93/pc.
		150	73024150		12	2309	34,86/pc.
		200	73024200		12	2309	39,41/pc.
		300	73024300		12	2309	54,99/pc.
		400	73024400		12	2309	84,79/pc.
		500	73024500		12	2309	120,42/pc.
	600	73024600		12	2309	137,65/pc.	
	Pièce de montée Click						
	Acier galvanisé Sendzimir	35x100	70025110		13	2309	31,38/pc.
		35x150	70025115		13	2309	35,03/pc.
	Livrée sous forme aplanie.	35x200	70025120		13	2309	40,15/pc.
		35x300	70025130		13	2309	46,53/pc.
		60x060	70025206		13	2309	23,68/pc.
		60x100	70025210	✓	13	2309	23,68/pc.
		60x150	70025215	✓	13	2309	28,33/pc.
		60x200	70025220	✓	13	2309	31,17/pc.
		60x300	70025230	✓	13	2309	46,92/pc.
		60x400	70025240		13	2309	62,12/pc.
		60x500	70025250		13	2309	68,41/pc.
		60x600	70025260		13	2309	89,69/pc.
		85x200	70025320		13	2309	47,87/pc.
	85x300	70025330		13	2309	56,56/pc.	
	85x400	70025340		13	2309	68,12/pc.	
	85x500	70025350		13	2309	99,56/pc.	
	85x600	70025360		13	2309	104,25/pc.	

	type	référence	📦 stock	page. catal.	groupe d'articles	prix en €	
	Couvercle pour pièce de montée Click						
	Acier galvanisé Sendzimir	60	73025060		13	2309	26,15/pc.
		100	73025100		13	2309	26,15/pc.
		150	73025150		13	2309	29,26/pc.
		200	73025200		13	2309	33,45/pc.
		300	73025300		13	2309	46,78/pc.
		400	73025400		13	2309	71,96/pc.
		500	73025500		13	2309	103,34/pc.
	600	73025600		13	2309	118,06/pc.	
	Pièce de descente Click						
	Acier galvanisé Sendzimir	35x100	70026110		13	2309	31,38/pc.
		35x150	70026115		13	2309	35,03/pc.
	Livrée sous forme aplanie.	35x200	70026120		13	2309	40,15/pc.
		35x300	70026130		13	2309	46,53/pc.
		60x060	70026206		13	2309	23,68/pc.
		60x100	70026210	✓	13	2309	23,68/pc.
		60x150	70026215	✓	13	2309	28,33/pc.
		60x200	70026220	✓	13	2309	31,17/pc.
		60x300	70026230	✓	13	2309	46,92/pc.
		60x400	70026240	✓	13	2309	62,12/pc.
		60x500	70026250		13	2309	68,41/pc.
		60x600	70026260		13	2309	89,69/pc.
		85x200	70026320		13	2309	42,03/pc.
		85x300	70026330		13	2309	57,78/pc.
		85x400	70026340		13	2309	64,84/pc.
	85x500	70026350		13	2309	77,61/pc.	
	85x600	70026360		13	2309	82,16/pc.	
	Couvercle pour pièce de descente Click						
	Acier galvanisé Sendzimir	60	73026060		13	2309	25,29/pc.
		100	73026100		13	2309	25,29/pc.
		150	73026150		13	2309	28,34/pc.
		200	73026200		13	2309	32,35/pc.
		300	73026300		13	2309	45,31/pc.
		400	73026400		13	2309	69,69/pc.
		500	73026500		13	2309	100,05/pc.
	600	73026600		13	2309	114,35/pc.	
	Dérivation universelle Click						
	Acier galvanisé Sendzimir	35	70021100		14	2309	13,81/pc.
		60	70021200	✓	14	2309	14,42/pc.
	Livrée sous forme aplanie.	85	70021300		14	2309	17,40/pc.
		100	70021400		14	2309	17,51/pc.





Chemin de câbles Pemsaband LX Click, H = 35 mm

Acier galvanisé à chaud

type	référence	stock	page. catal.	groupe d'articles	prix en €
↔ 3 m  24 m	35x100 75831100		8	2308	21,24/m
 12 m	35x150 75831150		8	2308	26,45/m
	35x200 75831200		8	2308	32,96/m
	35x300 75831300		8	2308	44,15/m



Chemin de câbles Pemsaband LX Click, H = 60 mm

Acier galvanisé à chaud

↔ 3 m  24 m	60x100 75832100			2310	22,45/m
 12 m	60x150 75832150			2310	28,04/m
	60x200 75832200			2310	32,30/m
 6 m	60x300 75832300			2310	43,19/m
	60x400 75832400			2310	55,05/m
	60x500 75832500			2310	67,45/m
	60x600 75832600			2310	77,56/m

Chemin de câbles Pemsaband SX Click, H = 60 mm

Acier galvanisé à chaud

↔ 3 m  24 m	60x100 75232100	✓	8	2308	26,53/m
 12 m	60x150 75232150		8	2308	31,32/m
	60x200 75232200	✓	8	2308	37,65/m
 6 m	60x300 75232300	✓	8	2308	47,93/m
	60x400 75232400	✓	8	2308	61,91/m
	60x500 75232500		8	2308	81,81/m
	60x600 75232600		8	2308	97,13/m

Chemin de câbles Pemsaband LX Click, H = 85 mm

Acier galvanisé à chaud

↔ 3 m  6 m	85x200 75233200		8	2308	44,04/m
	85x300 75233300		8	2308	60,59/m
	85x400 75233400		8	2308	76,03/m
	85x500 75233500		8	2308	88,92/m
	85x600 75233600		8	2308	103,21/m

Chemin de câbles Pemsaband LX, H = 100 mm

Acier galvanisé à chaud

↔ 3 m  6 m	100x200 75234200		8	2308	47,33/m
	100x300 75234300		8	2308	58,27/m
	100x400 75234400		8	2308	80,59/m
	100x500 75234500		8	2308	92,88/m
	100x600 75234600		8	2308	108,20/m

Accouplement Reijband-Pemsaband

Acier galvanisé à chaud

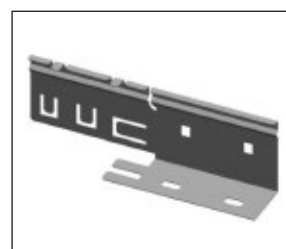

 1 set	60	70130200		20	2309	25,74/set
---	----	----------	--	----	------	-----------







Gaine à câbles Inducanal Click, H= 35 mm

Acier galvanisé à chaud

type	référence	stock	page. catal.	groupe d'articles	prix en €
↔ 3 m  24 m	35x100 75131100		8	2311	23,66/m
 12 m	35x150 75131150		8	2311	27,13/m
	35x200 75131200		8	2311	32,91/m
	35x300 75131300		8	2311	43,24/m

Gaine à câbles Inducanal Click, H= 60 mm

Acier galvanisé à chaud

↔ 3 m  24 m	60x060 75132060	✓	8	2311	26,64/m
	60x100 75132100		8	2311	26,64/m
 12 m	60x150 75132150		8	2311	34,62/m
	60x200 75132200		8	2311	36,75/m
 6 m	60x300 75132300		8	2311	47,03/m
	60x400 75132400		8	2311	88,31/m
	60x500 75132500		8	2311	99,56/m
	60x600 75132600		8	2311	114,28/m

Gaine à câbles Inducanal Click, H= 85 mm

Acier galvanisé à chaud

↔ 3 m  6 m	85x200 75433200		8	2311	44,40/m
	85x300 75433300		8	2311	55,66/m
	85x400 75433400		8	2311	94,46/m
	85x500 75433500		8	2311	115,75/m
	85x600 75433600		8	2311	125,90/m

Gaine à câbles Inducanal, H = 100 mm

Acier galvanisé à chaud

↔ 3 m  6 m	100x200 75434200		8	2311	48,24/m
	100x300 75434300		8	2311	58,94/m
	100x400 75434400		8	2311	97,44/m
	100x500 75434500		8	2311	119,82/m
	100x600 75434600		8	2311	148,77/m

Boulon à collet carré et écrou 6 pans à embase crénelée

Acier galvanisé à chaud

 100 pc.	M6x12 67030093	✓		2309	0,49/pc.
---	----------------	---	--	------	----------

Boulon à collet carré









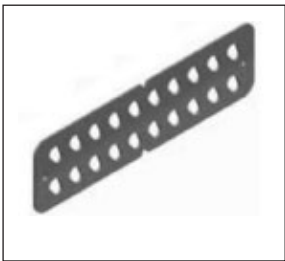
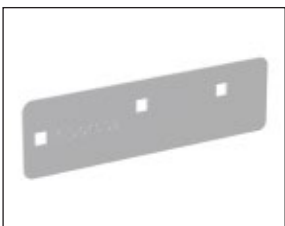

Acier galvanisé à chaud

 100 pc.	M6x12 67030099	✓	9	2309	0,33/pc.
	M6x20 67030100			2309	0,46/pc.

Écrou 6 pans à embase crénelée



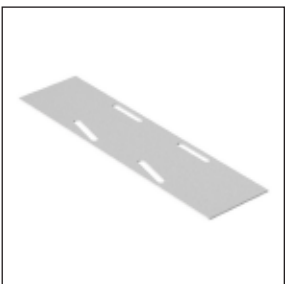

Acier galvanisé à chaud



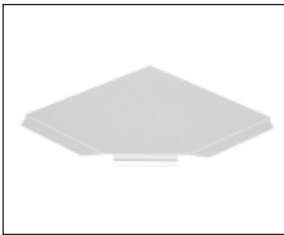

 50 pc.	M6 64030059	✓	9	2309	0,25/pc.
--	-------------	---	---	------	----------

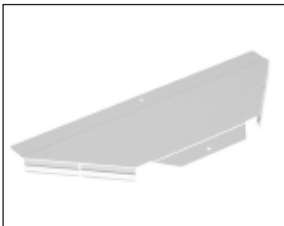

	type	référence	stock	page. catal.	groupe d'articles	prix en €
	Accouplement					
Acier galvanisé à chaud	35	71031005	✓	9	2309	1,94/pc.
	Accouplement					
Acier galvanisé à chaud	60	93930002	✓		2309	3,10/pc.
	Accouplement					
Acier galvanisé à chaud	85/100	93930003			2309	5,35/pc.
	Plaque pour pièce de montée/descente					
Acier galvanisé à chaud	35	71031006		9	2309	1,71/pc.
 4 pc.						
4 plaques pour 1 pièce de montée/descente.						
	Plaque pour pièce de montée/descente					
Acier galvanisé à chaud	60	93930012	✓		2309	2,69/pc.
 8 pc.						
4 plaques pour 1 pièce de montée/descente.						
	Plaque pour pièce de montée/descente					
Acier galvanisé à chaud	85/100	93930013		10	2309	5,05/pc.
 8 pc.						
4 plaques pour 1 pièce de montée/descente.						
	Accouplement de fond					
Acier galvanisé à chaud	300	71030300		9	2309	11,56/pc.
 10 pc.	400	71030400		9	2309	13,38/pc.
	500	71030500		9	2309	18,25/pc.
	600	71030600		9	2309	21,90/pc.

	type	référence	stock	page. catal.	groupe d'articles	prix en €		
	Plaque de montage Pemsaband							
	Acier galvanisé à chaud	60	70430911	15	2309	9,31/pc.		
	 10 pc.							
	Bande de protection							
	Caoutchouc/adhésif		71000000	✓	15	2309	7,00/m	
	 25 m							
	Borne de terre							
	Cuivre	16-50 mm ²	68000034	✓	15	2309	5,95/pc.	
	 20 pc.							
	Couvercle Click							
	Acier galvanisé à chaud							
	↔ 3 m	 24 m	60	73031060	✓	8	2316	11,86/m
			100	73031100	✓	8	2316	16,55/m
		 12 m	150	73031150	✓	8	2316	22,50/m
			200	73031200	✓	8	2316	28,47/m
		 6 m	300	73031300	✓	8	2316	43,30/m
			400	73031400		8	2316	56,07/m
			500	73031500		8	2316	68,84/m
			600	73031600		8	2316	81,62/m
	Cloison de séparation							
	Acier galvanisé à chaud							
	↔ 3 m	 60 m	25	67030610	✓	10	2316	9,67/m
		 48 m	50	67030611	✓	10	2316	13,13/m
	 36 m	80	67030612		10	2316	18,49/m	
	Plaque d'identification							
	Matière synthétique		68000020	10	2307	1,17/pc.		
	 50 pc.							

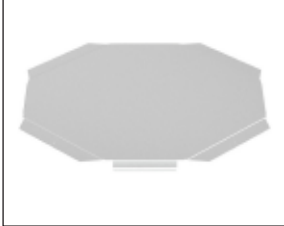

	type	référence	🌀 stock	page. catalog.	groupe d'articles	prix en €	
	Courbe réglable						
	Acier galvanisé à chaud	35x100	70038110		14	2309	40,76/pc.
		35x150	70038115		14	2309	43,60/pc.
		35x200	70038120		14	2309	51,88/pc.
		35x300	70038130		14	2309	60,52/pc.
		60x100	70038210		14	2309	41,96/pc.
		60x150	70038215		14	2309	45,43/pc.
		60x200	70038220		14	2309	53,83/pc.
60x300		70038230		14	2309	63,44/pc.	
	Embout						
	Acier galvanisé à chaud	35x100	70039110		14	2309	23,90/pc.
		35x150	70039115		14	2309	31,21/pc.
		35x200	70039120		14	2309	36,43/pc.
		35x300	70039130		14	2309	48,54/pc.
		60x100	70039210		14	2309	25,79/pc.
		60x150	70039215		14	2309	32,96/pc.
		60x200	70039220		14	2309	39,90/pc.
60x300		70039230		14	2309	55,10/pc.	
	Réduction						
	Acier galvanisé à chaud	35x100	71031010		14	2309	24,33/pc.
		35x150	71031015		14	2309	31,68/pc.
		35x200	71031020		14	2309	36,98/pc.
		35x300	71031030		14	2309	49,27/pc.
		60x100	71032010		14	2309	26,15/pc.
		60x150	71032015		14	2309	33,45/pc.
		60x200	71032020		14	2309	40,50/pc.
60x300		71032030		14	2309	52,79/pc.	
	Pièce murale verticale						
	Acier galvanisé à chaud	60x100	70037100		20	2309	37,40/pc.
		60x150	70037150		20	2309	42,15/pc.
	Courbe Click 90°						
	Acier galvanisé à chaud	35x100	70030110		11	2309	29,32/pc.
		35x150	70030115		11	2309	32,66/pc.
		35x200	70030120		11	2309	37,52/pc.
		35x300	70030130		11	2309	49,69/pc.
		60x100	70030210	✓	11	2309	31,51/pc.
		60x150	70030215		11	2309	34,17/pc.
		60x200	70030220	✓	11	2309	39,11/pc.
		60x300	70030230	✓	11	2309	53,17/pc.
		60x400	70030240		11	2309	91,12/pc.
		60x500	70030250		11	2309	139,35/pc.
		60x600	70030260		11	2309	168,18/pc.
		85x200	70030320		11	2309	43,06/pc.
		85x300	70030330		11	2309	56,86/pc.
		85x400	70030340		11	2309	108,98/pc.
		85x500	70030350		11	2309	153,38/pc.
		85x600	70030360		11	2309	176,45/pc.
		100x200	70030420		11	2309	76,75/pc.
100x300		70030430		11	2309	92,27/pc.	
100x400	70030440		11	2309	166,77/pc.		
100x500	70030450		11	2309	200,67/pc.		
100x600	70030460		11	2309	260,02/pc.		





	type	référence	🌀 stock	page. catal.	groupe d'articles	prix en €	
	Couvercle pour courbe Click 90°						
	Acier galvanisé à chaud	100	73030100	11	2309	25,59/pc.	
		150	73030150	11	2309	28,71/pc.	
		200	73030200	11	2309	32,05/pc.	
		300	73030300	11	2309	45,80/pc.	
		400	73030400	11	2309	76,89/pc.	
		500	73030500	11	2309	98,95/pc.	
	Pièce en T Click						
	Acier galvanisé à chaud	35x100	70032110	11	2309	40,81/pc.	
		35x150	70032115	11	2309	45,55/pc.	
		35x200	70032120	11	2309	53,41/pc.	
		35x300	70032130	11	2309	59,85/pc.	
		60x100	70032210	✓	11	2309	43,49/pc.
		60x150	70032215		11	2309	47,63/pc.
		60x200	70032220	✓	11	2309	54,43/pc.
		60x300	70032230	✓	11	2309	70,24/pc.
		60x400	70032240		11	2309	119,76/pc.
		60x500	70032250		11	2309	166,23/pc.
		60x600	70032260		11	2309	199,86/pc.
		85x200	70032320		11	2309	61,98/pc.
		85x300	70032330		11	2309	84,90/pc.
		85x400	70032340		11	2309	166,35/pc.
		85x500	70032350		11	2309	208,33/pc.
		85x600	70032360		11	2309	254,36/pc.
	Couvercle pour pièce en T Click						
	Acier galvanisé à chaud	100	73032100	11	2309	51,21/pc.	
		150	73032150	11	2309	55,76/pc.	
		200	73032200	11	2309	62,76/pc.	
		300	73032300	11	2309	85,33/pc.	
		400	73032400	11	2309	134,17/pc.	
		500	73032500	11	2309	192,92/pc.	
	Dérivation Click						
	Acier galvanisé à chaud	35x100	70033110	12	2309	31,38/pc.	
		35x150	70033115	12	2309	35,03/pc.	
		35x200	70033120	12	2309	41,11/pc.	
		35x300	70033130	12	2309	47,63/pc.	
		60x100	70033210	✓	12	2309	33,45/pc.
		60x150	70033215		12	2309	37,47/pc.
		60x200	70033220	✓	12	2309	42,82/pc.
		60x300	70033230	✓	12	2309	49,45/pc.
		60x400	70033240	✓	12	2309	58,21/pc.
		60x500	70033250		12	2309	63,62/pc.
		60x600	70033260		12	2309	69,47/pc.
		85x200	70033320		12	2309	50,42/pc.
		85x300	70033330		12	2309	56,86/pc.
		85x400	70033340		12	2309	60,81/pc.
		85x500	70033350		12	2309	68,07/pc.
		85x600	70033360		12	2309	70,91/pc.
		100x200	70033420		12	2309	54,80/pc.
		100x300	70033430		12	2309	61,31/pc.
		100x400	70033440		12	2309	67,57/pc.
	100x500	70033450		12	2309	74,31/pc.	
	100x600	70033460		12	2309	76,95/pc.	





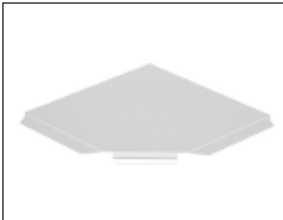

	type	référence	🌀 stock	page. catal.	groupe d'articles	prix en €	
	Couvercle pour dérivation Click						
	Acier galvanisé à chaud	100	73033100		12	2309	25,13/pc.
		150	73033150		12	2309	26,58/pc.
		200	73033200		12	2309	27,99/pc.
		300	73033300		12	2309	35,77/pc.
		400	73033400		12	2309	37,60/pc.
		500	73033500		12	2309	45,50/pc.
600		73033600		12	2309	47,68/pc.	
	Croisillon Click						
	Acier galvanisé à chaud	35x100	70034110		12	2309	45,63/pc.
		35x150	70034115		12	2309	50,37/pc.
		35x200	70034120		12	2309	58,32/pc.
		35x300	70034130		12	2309	67,63/pc.
		60x100	70034210		12	2309	47,49/pc.
		60x150	70034215		12	2309	52,61/pc.
		60x200	70034220		12	2309	60,76/pc.
		60x300	70034230		12	2309	82,00/pc.
		60x400	70034240		12	2309	130,78/pc.
		60x500	70034250		12	2309	187,87/pc.
		60x600	70034260		12	2309	215,37/pc.
		85x200	70034320		12	2309	68,48/pc.
		85x300	70034330		12	2309	91,48/pc.
		85x400	70034340		12	2309	138,26/pc.
85x500		70034350		12	2309	227,96/pc.	
85x600	70034360		12	2309	278,67/pc.		
	Couvercle pour croisillon Click						
	Acier galvanisé à chaud	100	73034100		12	2309	38,69/pc.
		150	73034150		12	2309	43,30/pc.
		200	73034200		12	2309	48,34/pc.
		300	73034300		12	2309	79,18/pc.
		400	73034400		12	2309	106,44/pc.
		500	73034500		12	2309	152,91/pc.
600		73034600		12	2309	174,67/pc.	
	Pièce de montée Click						
	Acier galvanisé à chaud	35x100	70035110		13	2309	38,74/pc.
		35x150	70035115		13	2309	43,24/pc.
		35x200	70035120		13	2309	49,57/pc.
		35x300	70035130		13	2309	57,47/pc.
		60x100	70035210		13	2309	40,76/pc.
		60x150	70035215		13	2309	45,68/pc.
		60x200	70035220		13	2309	52,18/pc.
		60x300	70035230		13	2309	72,07/pc.
		60x400	70035240		13	2309	94,72/pc.
		60x500	70035250		13	2309	110,70/pc.
		60x600	70035260		13	2309	120,73/pc.
		85x200	70035320		13	2309	60,40/pc.
		85x300	70035330		13	2309	74,57/pc.
		85x400	70035340		13	2309	89,60/pc.
85x500		70035350		13	2309	119,33/pc.	
85x600	70035360		13	2309	124,26/pc.		
	Couvercle pour pièce de montée Click						
	Acier galvanisé à chaud	100	73035100		13	2309	32,24/pc.
		150	73035150		13	2309	36,13/pc.
		200	73035200		13	2309	41,29/pc.
		300	73035300		13	2309	67,70/pc.
		400	73035400		13	2309	88,80/pc.
		500	73035500		13	2309	127,54/pc.
600		73035600		13	2309	127,54/pc.	

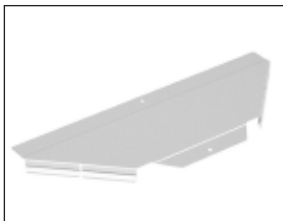
	type	référence	📦 stock	page. catal.	groupe d'articles	prix en €	
	Pièce de descente Click						
	Acier galvanisé à chaud	35x100	70036110		13	2309	39,35/pc.
		35x150	70036115		13	2309	43,99/pc.
		35x200	70036120		13	2309	50,37/pc.
		35x300	70036130		13	2309	58,40/pc.
		60x100	70036210		13	2309	41,00/pc.
		60x150	70036215		13	2309	45,92/pc.
		60x200	70036220		13	2309	52,49/pc.
		60x300	70036230		13	2309	64,49/pc.
		60x400	70036240		13	2309	83,98/pc.
		60x500	70036250		13	2309	94,73/pc.
		60x600	70036260		13	2309	98,40/pc.
		85x200	70036320		13	2309	54,80/pc.
		85x300	70036330		13	2309	68,97/pc.
		85x400	70036340		13	2309	83,39/pc.
	85x500	70036350		13	2309	96,05/pc.	
	85x600	70036360		13	2309	99,70/pc.	
	Couvercle pour pièce de descente Click						
	Acier galvanisé à chaud	100	73036100		13	2309	30,97/pc.
		150	73036150		13	2309	34,67/pc.
		200	73036200		13	2309	39,60/pc.
		300	73036300		13	2309	55,41/pc.
		400	73036400		13	2309	85,21/pc.
		500	73036500		13	2309	122,44/pc.
	600	73036600		13	2309	139,89/pc.	
	Dérivation universelle Click						
	Acier galvanisé à chaud	35	70031100		14	2309	19,72/pc.
		60	70031200		14	2309	21,09/pc.
		85	70031300	✓	14	2309	24,99/pc.
		100	70031400		14	2309	25,54/pc.







	type	référence	stock	page. catal.	groupe d'articles	prix en €	
	Chemin de câbles Pemsaband, H = 60 mm						
	Acier inoxydable AISI 304						
	↔ 3 m	 24 m	60x100 76452100	✓		2315	62,87/m
		 12 m	60x150 76452150			2315	63,54/m
			60x200 76452200	✓		2315	87,71/m
		 6 m	60x300 76452300	✓		2315	110,53/m
			60x400 76452400			2315	112,79/m
		60x500 76452500			2315	154,51/m	
		60x600 76452600			2315	195,65/m	
	Gaine à câbles Inducanal, H = 60 mm						
	Acier inoxydable AISI 304						
	↔ 3 m	 24 m	60x100 76552100	✓		2315	61,11/m
		 12 m	60x150 76552150			2315	63,78/m
			60x200 76552200	✓		2315	87,85/m
		 6 m	60x300 76552300	✓		2315	110,76/m
			60x400 76552400			2315	112,98/m
		60x500 76552500			2315	155,31/m	
		60x600 76552600			2315	196,38/m	
	Boulon à collet carré						
	Acier inoxydable AISI 316L	M6x12	67060099	✓	2309	1,70/pc.	
	Ecrou 6 pans à embase crénelée						
	Acier inoxydable AISI 316L	M6	64060059	✓	2309	1,00/pc.	
	 100 pc.						
	Accouplement						
	Acier inoxydable AISI 304	60	93950002	✓	2309	7,75/pc.	
	 50 pc.						
	Plaque pour pièce de montée/descente						
	Acier inoxydable AISI 304	60	93950012	✓	2309	8,06/pc.	
	 8 pc.						
	4 plaques pour 1 pièce de montée/descente.						

	type	référence	stock	page. catal.	groupe d'articles	prix en €
	Accouplement					
	Acier inoxydable AISI 304	300	71050300		2309	17,13/pc.
	 10 pc.	400	71050400		2309	23,37/pc.
		500	71050500		2309	28,89/pc.
		600	71050600		2309	33,72/pc.
	Couvercle Click					
	Acier inoxydable AISI 304					
	↔ 3 m  24 m	100	73051100	✓	2316	42,12/m
	 12 m	150	73051150	✓	2316	56,19/m
		200	73051200	✓	2316	68,81/m
		300	73051300	✓	2316	96,18/m
	 6 m	400	73051400		2316	124,16/m
		500	73051500		2316	135,10/m
		600	73051600		2316	185,28/m
		Cloison de séparation				
Acier inoxydable 316L		50	67060611		2316	43,58/m
	↔ 3 m  48 m					
	Courbe réglable					
	Acier inoxydable AISI 304	60x100	70058210		2309	38,17/pc.
		60x150	70058215		2309	60,52/pc.
		60x200	70058220		2309	66,75/pc.
		60x300	70058230		2309	112,15/pc.
	Embout et réduction					
	Acier inoxydable AISI 304	60x100	71052010		2309	45,01/pc.
		60x150	71052015		2309	58,63/pc.
		60x200	71052020		2309	77,68/pc.
		60x300	71052030		2309	100,12/pc.

	type	référence	🌀 stock	page. catal.	groupe d'articles	prix en €
	Courbe Click 90°					
	Acier inoxydable AISI 304	60x100	70050210	✓	2309	49,35/pc.
		60x150	70050215		2309	55,66/pc.
		60x200	70050220	✓	2309	86,46/pc.
		60x300	70050230		2309	112,98/pc.
		60x400	70050240		2309	158,99/pc.
		60x500	70050250		2309	231,36/pc.
	60x600	70050260		2309	234,17/pc.	
	Couvercle pour courbe Click 90°					
	Acier inoxydable AISI 304	100	73050100		2309	53,22/pc.
		150	73050150		2309	63,35/pc.
		200	73050200		2309	88,34/pc.
		300	73050300		2309	95,57/pc.
		400	73050400		2309	172,96/pc.
		500	73050500		2309	217,43/pc.
	600	73050600		2309	223,46/pc.	
	Pièce en T Click					
	Acier inoxydable AISI 304	60x100	70052210	✓	2309	60,61/pc.
		60x150	70052215		2309	66,23/pc.
		60x200	70052220	✓	2309	85,30/pc.
		60x300	70052230		2309	112,98/pc.
		60x400	70052240		2309	228,85/pc.
		60x500	70052250		2309	230,97/pc.
	60x600	70052260		2309	232,73/pc.	
	Couvercle pour pièce en T Click					
	Acier inoxydable AISI 304	100	73052100		2309	72,15/pc.
		150	73052150		2309	89,65/pc.
		200	73052200		2309	113,43/pc.
		300	73052300		2309	148,19/pc.
		400	73052400		2309	286,26/pc.
		500	73052500		2309	311,33/pc.
	600	73052600		2309	305,25/pc.	
	Dérivation Click					
	Acier inoxydable AISI 304	60x100	70053210		2309	44,55/pc.
		60x150	70053215		2309	44,79/pc.
		60x200	70053220		2309	57,11/pc.
		60x300	70053230		2309	57,47/pc.
		60x400	70053240		2309	79,83/pc.
		60x500	70053250		2309	79,91/pc.
	60x600	70053260		2309	80,44/pc.	
	Couvercle pour dérivation Click					
	Acier inoxydable AISI 304	100	73053100		2309	48,51/pc.
		150	73053150		2309	50,02/pc.
		200	73053200		2309	50,87/pc.
		300	73053300		2309	66,37/pc.
		400	73053400		2309	64,09/pc.
		500	73053500		2309	89,72/pc.
	600	73053600		2309	92,91/pc.	

	type	référence	🌀 stock	page. catal.	groupe d'articles	prix en €
	Croisillon Click					
	Acier inoxydable AISI 304	60x100	70054210		2309	66,44/pc.
		60x150	70054215		2309	96,79/pc.
		60x200	70054220		2309	88,20/pc.
		60x300	70054230		2309	157,83/pc.
		60x400	70054240		2309	228,55/pc.
		60x500	70054250		2309	231,36/pc.
	60x600	70054260		2309	310,43/pc.	
	Couvercle pour croisillon Click					
	Acier inoxydable AISI 304	100	73054100		2309	84,78/pc.
		150	73054150		2309	105,91/pc.
		200	73054200		2309	103,70/pc.
		300	73054300		2309	182,63/pc.
		400	73054400		2309	236,07/pc.
		500	73054500		2309	295,53/pc.
	600	73054600		2309	349,20/pc.	
	Pièce de montée Click					
	Acier inoxydable AISI 304	60x100	70055210		2309	58,69/pc.
		60x150	70055215		2309	69,11/pc.
		60x200	70055220		2309	70,18/pc.
		60x300	70055230		2309	85,91/pc.
		60x400	70055240		2309	109,64/pc.
		60x500	70055250		2309	158,83/pc.
	60x600	70055260		2309	158,83/pc.	
	Couvercle pour pièce de montée Click					
	Acier inoxydable AISI 304	100	73055100		2309	50,95/pc.
		150	73055150		2309	57,63/pc.
		200	73055200		2309	67,14/pc.
		300	73055300		2309	97,55/pc.
		400	73055400		2309	119,82/pc.
		500	73055500		2309	144,69/pc.
	600	73055600		2309	216,46/pc.	
	Pièce de descente Click					
	Acier inoxydable AISI 304	60x100	70056210		2309	43,19/pc.
		60x150	70056215		2309	50,79/pc.
		60x200	70056220		2309	67,14/pc.
		60x300	70056230		2309	82,41/pc.
		60x400	70056240		2309	107,65/pc.
		60x500	70056250		2309	118,45/pc.
	60x600	70056260		2309	129,40/pc.	
	Couvercle pour pièce de descente Click					
	Acier inoxydable AISI 304	100	73056100		2309	72,61/pc.
		150	73056150		2309	76,33/pc.
		200	73056200		2309	94,27/pc.
		300	73056300		2309	121,04/pc.
		400	73056400		2309	185,06/pc.
		500	73056500		2309	253,64/pc.
	600	73056600		2309	320,99/pc.	
	Dérivation universelle Click					
	Acier inoxydable AISI 304	60	70051200		2309	20,77/pc.

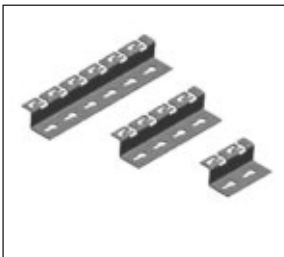
Systemes de suspension – chemins et gaines à câbles

	type	référence	stock	page. catal.	groupe d'articles	prix en €	
	RPLUS console Click						
	Acier galvanisé Sendzimir	100	62025103	✓	16	2307	7,86/pc.
	 4 pc.	150	62025153	✓	16	2307	9,17/pc.
		200	62025203	✓	16	2307	10,55/pc.
		300	62025303	✓	16	2307	12,08/pc.
		400	62025403		16	2307	17,44/pc.
		500	62025503		16	2307	20,24/pc.
600		62025603		16	2307	23,03/pc.	
	RPLUS console Click						
	Acier galvanisé à chaud	100	62035103	✓	16	2307	12,14/pc.
	 4 pc.	150	62035153	✓	16	2307	13,57/pc.
		200	62035203	✓	16	2307	16,03/pc.
		300	62035303	✓	16	2307	19,85/pc.
		400	62035403	✓	16	2307	22,20/pc.
		500	62035503		16	2307	27,68/pc.
600		62035603		16	2307	32,21/pc.	
	RPLUS console						
	Acier inoxydable AISI 304	100	62055103	✓		2307	27,32/pc.
	 4 pc.	150	62055153	✓		2307	30,12/pc.
		200	62055203	✓		2307	33,69/pc.
		300	62055303	✓		2307	40,90/pc.
	 4 pc.	400	62055403	✓		2307	68,52/pc.
		500	62055503	✓		2307	77,33/pc.
600		62055603	✓		2307	87,86/pc.	
		Kit embout étrier réglable					
	Acier galvanisé à chaud		62037002		16	2307	19,53/pc.
	Kit embout étrier réglable						
	Acier inoxydable AISI 304		62057002			2307	sur demande
	RPLUS distanceur Click						
	Acier galvanisé Sendzimir	100	67020520	✓	16	2307	7,83/pc.
	 10 pc.	200	67020522	✓	16	2307	9,36/pc.
		300	67020524	✓	16	2307	10,76/pc.
RPLUS distanceur Click							
Acier galvanisé à chaud	100	67030520	✓	16	2307	9,71/pc.	
 10 pc.	200	67030522	✓	16	2307	12,35/pc.	
	300	67030524	✓	16	2307	14,86/pc.	
	RPLUS distanceur Click						
Acier inoxydable AISI 304	100	67050520	✓		2307	12,10/pc.	
 10 pc.	200	67050522	✓		2307	19,97/pc.	
	300	67050524	✓		2307	27,49/pc.	

Systemes de suspension – chemins et gaines à câbles



SPLUS console Oméga Click

	type	référence	stock	page. catal.	groupe d'articles	prix en €
Acier galvanisé Sendzimir 5 pc.	100	62021104	✓	17	2307	6,29/pc.
	150	62021154	✓	17	2307	8,13/pc.
	200	62021204	✓	17	2307	9,31/pc.
	300	62021304	✓	17	2307	10,98/pc.
	400	62021404	✓	17	2307	16,42/pc.

SPLUS console Oméga Click

	type	référence	stock	page. catal.	groupe d'articles	prix en €
Acier galvanisé à chaud 5 pc.	100	62031104	✓	17	2307	9,63/pc.
	150	62031154		17	2307	12,32/pc.
	200	62031204	✓	17	2307	13,20/pc.
	300	62031304	✓	17	2307	14,12/pc.
	400	62031404		17	2307	21,79/pc.

SPLUS console Oméga Click

	type	référence	stock	page. catal.	groupe d'articles	prix en €
Acier inoxydable AISI 304 5 pc.	100	62051104			2307	19,90/pc.
	150	62051154			2307	24,69/pc.
	200	62051204			2307	31,06/pc.
	300	62051304			2307	37,64/pc.
	400	62051404			2307	45,79/pc.

SPLUS pendard Oméga

	type	référence	stock	page. catal.	groupe d'articles	prix en €
Acier galvanisé Sendzimir 5 pc.	500	62021504	✓	18	2307	18,77/pc.
	600	62021604	✓	18	2307	22,39/pc.

SPLUS pendard Oméga

	type	référence	stock	page. catal.	groupe d'articles	prix en €
Acier galvanisé à chaud 5 pc.	500	62031504		18	2307	25,27/pc.
	600	62031604		18	2307	30,25/pc.

SPLUS pendard Oméga

	type	référence	stock	page. catal.	groupe d'articles	prix en €
Acier inoxydable AISI 304 5 pc.	500	62051504			2307	52,91/pc.
	600	62051604			2307	60,21/pc.



SPLUS étrier en C Oméga Click

	type	référence	stock	page. catal.	groupe d'articles	prix en €
Acier galvanisé Sendzimir 4 pc.	100	62022104	✓	17	2307	12,42/pc.
	150	62022154	✓	17	2307	13,05/pc.
	200	62022204	✓	17	2307	14,03/pc.
	300	62022304	✓	17	2307	16,42/pc.
	400	62022404	✓	17	2307	24,23/pc.

SPLUS étrier en C Oméga Click

	type	référence	stock	page. catal.	groupe d'articles	prix en €
Acier galvanisé à chaud 4 pc.	100	62032104	✓	17	2307	16,42/pc.
	150	62032154		17	2307	18,06/pc.
	200	62032204	✓	17	2307	20,16/pc.
	300	62032304	✓	17	2307	24,16/pc.
	400	62032404		17	2307	36,94/pc.

SPLUS étrier en C Oméga Click

	type	référence	stock	page. catal.	groupe d'articles	prix en €
Acier inoxydable AISI 304 4 pc.	100	62052104			2307	33,97/pc.
	150	62052154			2307	36,84/pc.
	200	62052204			2307	48,44/pc.
	300	62052304			2307	55,65/pc.
	400	62052404			2307	64,31/pc.



Systemes de suspension – chemins et gaines à câbles



SPLUS console Oméga Click

type	référence	stock	page. catal.	groupe d'articles	prix en €	
Acier galvanisé Sendzimir	100	63022104	✓	17	2307	4,26/pc.
 10 pc.	150	63022154	✓	17	2307	4,70/pc.
	200	63022204	✓	17	2307	5,90/pc.
	300	63022304	✓	17	2307	6,94/pc.
	400	63022404	✓	17	2307	9,38/pc.
	500	63022504	✓	17	2307	10,57/pc.
	600	63022604	✓	17	2307	13,97/pc.

SPLUS console Oméga Click

type	référence	stock	page. catal.	groupe d'articles	prix en €	
Acier galvanisé à chaud	100	63032104		17	2307	7,08/pc.
 10 pc.	150	63032154		17	2307	7,57/pc.
	200	63032204		17	2307	9,26/pc.
	300	63032304		17	2307	11,11/pc.
	400	63032404		17	2307	13,49/pc.
	500	63032504		17	2307	15,93/pc.
	600	63032604		17	2307	19,06/pc.

SPLUS console Oméga Click

type	référence	stock	page. catal.	groupe d'articles	prix en €
Acier inoxydable AISI 304	100	63052104	-	2307	13,53/pc.
 10 pc.	150	63052154	-	2307	16,34/pc.
	200	63052204	-	2307	18,95/pc.
	300	63052304	-	2307	23,67/pc.
	400	63052404	-	2307	30,11/pc.
	500	63052504	-	2307	36,77/pc.
	600	63052604	-	2307	44,60/pc.

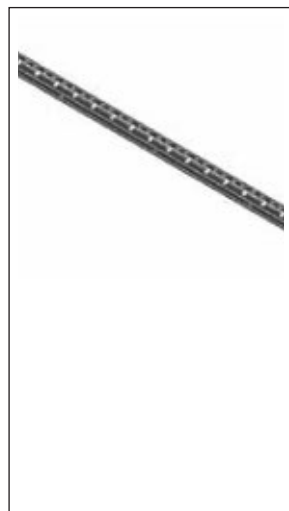

SPLUS profilé Oméga Click

type	référence	stock	page. catal.	groupe d'articles	prix en €
Acier galvanisé Sendzimir					
↔ 1 m	67020110		17	2307	28,31/m
↔ 2 m	67020111		17	2307	28,31/m
↔ 3 m	67020112		17	2307	28,31/m

SPLUS profilé Oméga Click

type	référence	stock	page. catal.	groupe d'articles	prix en €
Acier galvanisé à chaud					
↔ 1 m	67030110		17	2307	46,14/m
↔ 2 m	67030111		17	2307	46,14/m
↔ 3 m	67030112		17	2307	46,14/m



Etrier intérieur avec écrou M10

type	référence	stock	page. catal.	groupe d'articles	prix en €
Acier galvanisé Sendzimir	100	70122210	✓	2309	7,14/pc.
 10 pc.	150	70122215	✓	2309	8,65/pc.
	200	70122220	✓	2309	10,05/pc.
	300	70122230	✓	2309	12,99/pc.
	400	70122240	✓	2309	15,78/pc.

Etrier intérieur avec écrou M10

type	référence	stock	page. catal.	groupe d'articles	prix en €
Acier galvanisé à chaud	100	70132210		2309	9,95/pc.
 10 pc.	150	70132215		2309	12,05/pc.
	200	70132220		2309	14,26/pc.
	300	70132230		2309	18,48/pc.
	400	70132240		2309	22,57/pc.

Systemes de suspension – chemins et gaines à câbles

	type	référence	📦 stock	page. catal.	groupe d'articles	prix en €
	Ecrou hexagonal					
	Acier à zingage électrolytique	M8	67020095		2307	0,17/pc.
	 100 pc.	M10	67020079		2307	0,20/pc.
	Ecrou hexagonal					
	Acier inoxydable AISI 304	M8	67060062		2307	1,08/pc.
	 100 pc.	M10	67060014		2307	2,47/pc.
	Rondelle					
	Acier à zingage électrolytique	M8	67020083		2307	0,08/pc.
	 100 pc.	M10	67020061		2307	0,20/pc.
	Rondelle					
	Acier inoxydable AISI 316	M8	67060063		2307	0,55/pc.
	 100 pc.	M10	67060064		2307	0,80/pc.
	Rondelle étoilée					
	Acier inoxydable	M8	67020084		2307	0,26/pc.
	 100 pc.					
	Rondelle étoilée					
	Acier inoxydable	M10	67020086		2307	0,35/pc.
	 100 pc.					
	Tige filetée					
	Acier à zingage électrolytique	M6	67010140		2307	2,93/pc.
	↔ 0,5 m					
	Tige filetée					
Acier inoxydable AISI 316	M8	67060044		2307	28,35/pc.	
↔ 0,5 m						
Tige filetée						
Acier à zingage électrolytique	M6	67010141		2307	3,76/m	
↔ 1 m						
Tige filetée						
Acier inoxydable AISI 316	M8	67060045		2307	37,01/m	
↔ 1 m	M10	67060145		2307	46,44/m	



Systèmes de support de câbles en matière composite



Le polyester renforcé de fibres de verre (Glass Reinforced Polymer) offre une excellente résistance au feu et à la corrosion. En outre, il ne subit aucune modification en cas de variations de température ou de conditions climatiques défavorables et la gamme est stable aux UV. C'est pourquoi le polyester renforcé de fibres de verre est la solution la plus rentable à long terme.

Notre gamme de produits renforcés de fibres de verre se compose de gaines (fermées) et d'échelles à câbles. De plus, nous proposons ces systèmes dans une gamme étendue de résines, en fonction de l'utilisation prévue.

Application:

- Chemins de fer
- Exploitation pétrolière et gazière
- Pétrochimie
- Navigation
- Tunnels
- Traitement des déchets



	<p>Gaine à câbles (fermée)</p> <p>Hauteur : 60 - 110 mm Largeur : 100 - 150 - 200 - 300 - 400 mm Longueur : 3000 mm</p>
	<p>Echelles à câbles</p> <p>Hauteur : 100 - 150 mm Largeur : 150 jusqu'à 1000 mm Longueur : 3000 - 6000 mm</p>
	<p>Profilsés</p> <p>Dimensions : 41,5 x 41,5 mm 85 x 43,5 mm (double) Longueur : 3000 mm</p>



rejiband® treillis à câbles

Gamme étendue des exécutions et traitements de surface

- ✓ zingage électrolytique
- ✓ zingage électrolytique, bichromaté
- ✓ galvanisation Sendzimir
- ✓ Black C8, Résistance Haute Protection, CLASS 8 IEC 61537
- ✓ acier inoxydable AISI 304 ou AISI 316

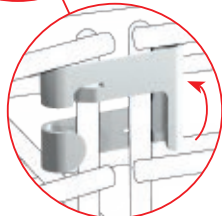
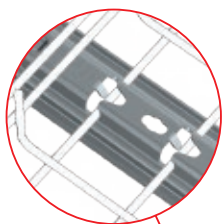

Système CLICK

- ✓ consoles et accessoires

Embouts de sécurité

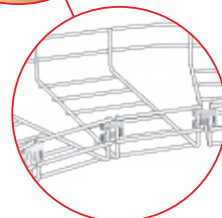
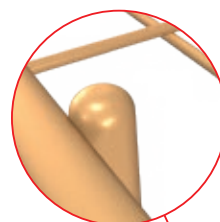

Système simple

- ✓ système à couper, courber et connecter
- ✓ gain de temps et de montage
- ✓ nombre d'accessoires limité

rejiband® RAPIDE

NEW

Seulement
en 2 clicks

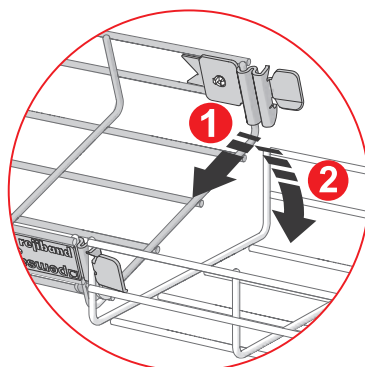
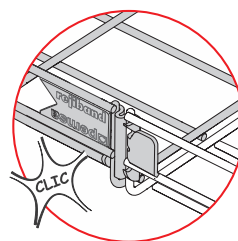

Le système
le plus rapide



rejiband®

rejitech®

rejiband®

rejiband®
black C8

rejiband®
rapide

rejitech®
rejitech G+®

treillis
angulaire



Caractéristiques

E.Z.	✓		✓	✓	
Z.B.	✓		✓	✓	✓
H.D.	✓			✓	✓
C8		✓		✓	
INOX 304	✓				✓
◀ mm	60-600	60-600	60-600	60-200	109
⬆ mm	35/60/100	35-60	60-100	60-100	60
L mm	3000	3000	3000	2000-3000	3000
⬇ N/m	⬇⬇⬇	⬇⬇⬇	⬇⬇⬇	⬇⬇	⬇⬇
🔥	E90				

Applications

🏢 Tertiaire	✓	✓	✓	✓	✓
🚶 Tunnels	✓	✓			
📊 Centres de donnée	✓	✓	✓	✓	✓
⚙️ Installations PV	✓	✓			
🌿 Industrie alimentaire	✓				
🏭 Petrochimie	✓				
📖 E.Z.	-	-	-	page 106	-
📖 Z.B.	page 87-90	-	page 92	page 106	page 107
📖 H.D.	page 87-90	-	-	-	page 107
📖 C8	-	page 87-89	-	-	-
📖 INOX 304	page 87-90	-	-	-	page 107

E.Z. zingage électrolytique NBN EN ISO 2081 – recommandé dans les environnements corrosifs C1 (très faible)
Z.B. zingage électrolytique, bichromaté NBN EN ISO 2081 – recommandé dans les environnements corrosifs C2 (faible)
H.D. galvanisation à chaud NBN EN ISO 1461 – recommandé dans les environnements corrosifs C3/C4 (moyen/haut)
C8 Black C8, Protection Haute Résistance, recommandé dans les environnements corrosifs C5-I (très haut – industrie)
INOX 304 acier inoxydable AISI 304 – recommandé dans les environnements corrosifs C5-I (très haut – industrie)

📖 voir page 2

rejiband[®] 60x60-2

avec double fil



fixation spéciale



Installation facile



Charge élevée



Possibilités pour fixer

Fixation directe

Sur chaque type de support ou structure grâce au kit de fixation.

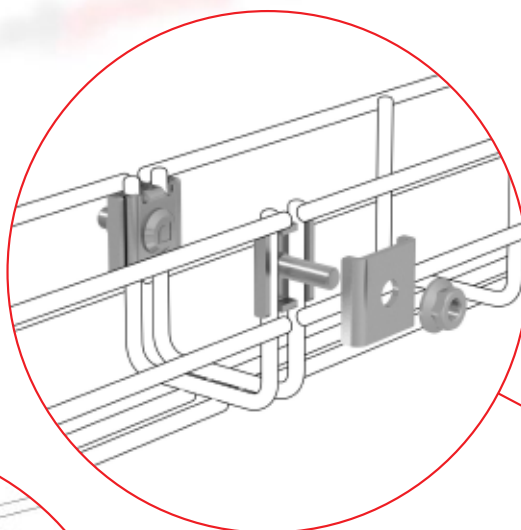

Accouplement renforcé

Pour un accouplement solide.

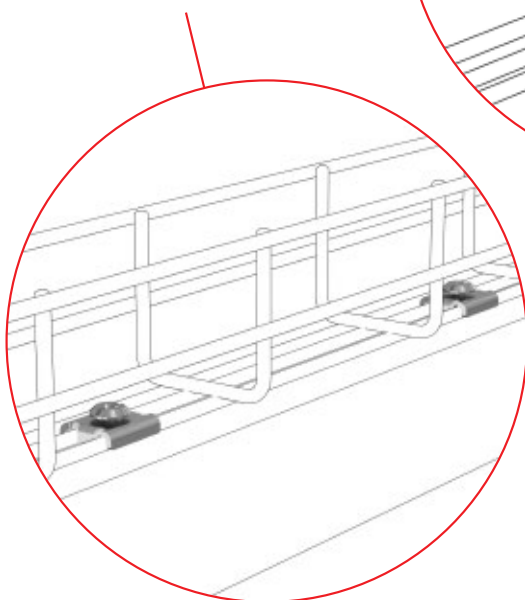

Fixation très simple sur un profilé avec un écrou coulissant

Le boulon à tête cruciforme et éclisse de branchement se vissent dans le boulon coulissant.

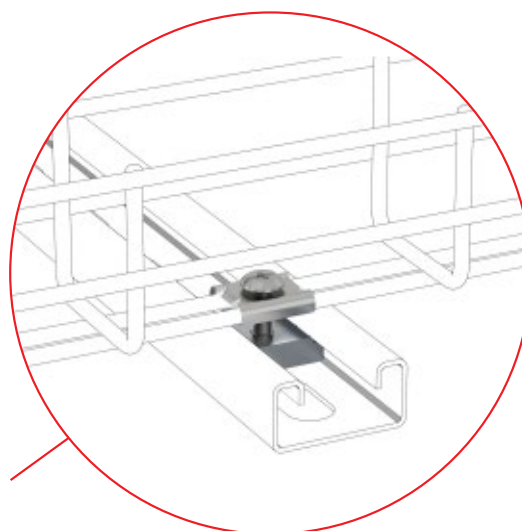









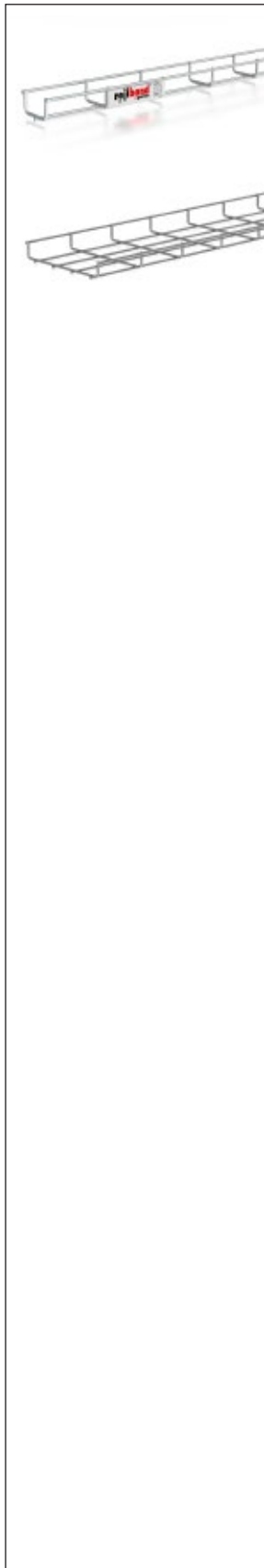







Treillis à câbles



	type	référence	stock	page. catal.	groupe d'articles	prix en €
Treillis à câbles Rejiband 60 avec deux fils dans le fond						
	Acier à zingage électrolytique	60 x 60-2 60212065	✓		2304	9,06/m
	↔ 3 m	18 m				
Treillis à câbles Rejiband 60 avec deux fils dans le fond						
	Acier à zingage électrolytique, bichromaté	60 x 60-2 60222065			2301	10,06/m
	↔ 3 m	18 m				
Treillis à câbles Rejiband 60 avec deux fils dans le fond						
	Acier galvanisé à chaud	60 x 60-2 60232065	✓		2305	15,02/m
	↔ 3 m	18 m				
Treillis à câbles Rejiband 60 avec deux fils dans le fond						
	Black C8	60 x 60-2 60282065	✓		2306	13,24/m
	↔ 3 m	18 m				
Treillis à câbles Rejiband 60 avec deux fils dans le fond						
	Acier inoxydable AISI 304	60 x 60-2 60252065	✓		2302	49,20/m
	↔ 3 m	18 m				
Accouplement pour les deux fils dans le fond						
	Acier à zingage électrolytique	60-2 64010058	✓		2307	0,72/pc.
	25 pc.					
Accouplement pour les deux fils dans le fond						
	Acier à zingage électrolytique, bichromaté	60-2 64020058			2307	0,78/pc.
	25 pc.					
Accouplement pour les deux fils dans le fond						
	Acier galvanisé à chaud	60-2 64030058	✓		2307	0,98/pc.
	25 pc.					
Accouplement pour les deux fils dans le fond						
	Black C8	60-2 64080058	✓		2307	1,00/pc.
	25 pc.					
Accouplement pour les deux fils dans le fond						
	Acier inoxydable AISI 316	60-2 64060058			2307	2,82/pc.
	25 pc.					

Treillis à câbles



	type	référence	stock	page. catal.	groupe d'articles	prix en €
Treillis à câbles Rejiband 35						
Acier à zingage électrolytique						
↔ 3 m	 24 m	35 x 60	60211060	✓	2304	9,09/m
		35 x 100	60211100	✓	2304	9,37/m
		35 x 150	60211150		2304	13,17/m
 18 m	35 x 200	60211200	✓	2304	14,40/m	
		60211300		2304	20,67/m	
 12 m	35 x 400	60211400		2304	25,91/m	
Treillis à câbles Rejiband 35						
Acier à zingage électrolytique, bichromaté						
↔ 3 m	 24 m	35 x 60	60221060	✓	2301	9,42/m
		35 x 100	60221100	✓	6 2301	9,71/m
		35 x 150	60221150		6 2301	13,64/m
 18 m	35 x 200	60221200	✓	6 2301	14,91/m	
		60221300	✓	6 2301	21,41/m	
 12 m	35 x 400	60221400		6 2301	26,85/m	
Treillis à câbles Rejiband 35						
Acier galvanisé à chaud						
↔ 3 m	 24 m	35 x 60	60231060	✓	2305	11,29/m
		35 x 100	60231100	✓	6 2305	12,49/m
		35 x 150	60231150		6 2305	16,16/m
 18 m	35 x 200	60231200		6 2305	18,35/m	
		60231300		6 2305	25,41/m	
 12 m	35 x 400	60231400		6 2305	30,21/m	
Treillis à câbles Rejiband 35						
Black C8						
↔ 3 m	 24 m	35 x 60	60281060	✓	2306	9,94/m
		35 x 100	60281100	✓	2306	11,00/m
		35 x 150	60281150		2306	14,21/m
 18 m	35 x 200	60281200	✓	2306	16,16/m	
		60281300		2306	22,35/m	
 12 m	35 x 400	60281400		2306	26,59/m	
Treillis à câbles Rejiband 35						
Acier inoxydable AISI 304						
↔ 3 m	 24 m	35 x 60	60251060	✓	2302	31,06/m
		35 x 100	60251100	✓	6 2302	37,01/m
		35 x 150	60251150		6 2302	44,05/m
 18 m	35 x 200	60251200		6 2302	57,02/m	
		60251300		6 2302	75,39/m	
 12 m	35 x 400	60251400		6 2302	113,02/m	

Treillis à câbles



Treillis à câbles Rejiband 60

	type	référence	stock	page. catal.	groupe d'articles	prix en €
↔ 3 m	Acier à zingage électrolytique	60 x 60	60212060	✓	2304	8,58/m
		60 x 100	60212100	✓	2304	10,99/m
		60 x 150	60212150	✓	2304	13,58/m
↔ 3 m	Acier à zingage électrolytique	60 x 200	60212200	✓	2304	15,40/m
		60 x 300	60212300	✓	2304	19,98/m
		60 x 400	60212400	✓	2304	28,71/m
↔ 3 m	Acier à zingage électrolytique	60 x 500	60212500	✓	2304	35,47/m
		60 x 600	60212600	✓	2304	42,02/m

Treillis à câbles Rejiband 60

	type	référence	stock	page. catal.	groupe d'articles	prix en €	
↔ 3 m	Acier à zingage électrolytique, bichromaté	60 x 60	60222060	✓	6	2301	9,46/m
		60 x 100	60222100	✓	6	2301	12,38/m
		60 x 150	60222150	✓	6	2301	15,30/m
↔ 3 m	Acier à zingage électrolytique	60 x 200	60222200	✓	6	2301	17,36/m
		60 x 300	60222300	✓	6	2301	22,50/m
		60 x 400	60222400	✓	6	2301	32,33/m
↔ 3 m	Acier à zingage électrolytique	60 x 500	60222500	✓	6	2301	39,94/m
		60 x 600	60222600	✓	6	2301	47,33/m

Treillis à câbles Rejiband 60

	type	référence	stock	page. catal.	groupe d'articles	prix en €	
↔ 3 m	Acier galvanisé à chaud	60 x 60	60232060	✓	6	2305	12,79/m
		60 x 100	60232100	✓	6	2305	17,30/m
		60 x 150	60232150	✓	6	2305	21,41/m
↔ 3 m	Acier galvanisé à chaud	60 x 200	60232200	✓	6	2305	25,35/m
		60 x 300	60232300	✓	6	2305	34,67/m
		60 x 400	60232400	✓	6	2305	45,79/m
↔ 3 m	Acier galvanisé à chaud	60 x 500	60232500	✓	6	2305	54,00/m
		60 x 600	60232600	✓	6	2305	63,73/m

Treillis à câbles Rejiband 60

	type	référence	stock	page. catal.	groupe d'articles	prix en €
↔ 3 m	Black C8	60 x 60	60282060	✓	2306	11,27/m
		60 x 100	60282100	✓	2306	15,26/m
		60 x 150	60282150	✓	2306	18,85/m
↔ 3 m	Black C8	60 x 200	60282200	✓	2306	22,32/m
		60 x 300	60282300	✓	2306	30,50/m
		60 x 400	60282400	✓	2306	40,29/m
↔ 3 m	Black C8	60 x 500	60282500	✓	2306	47,51/m
		60 x 600	60282600	✓	2306	56,07/m

Treillis à câbles Rejiband 60

	type	référence	stock	page. catal.	groupe d'articles	prix en €	
↔ 3 m	Acier inoxydable AISI 304	60 x 60	60252060	✓	6	2302	37,36/m
		60 x 100	60252100	✓	6	2302	50,88/m
		60 x 150	60252150	✓	6	2302	60,27/m
↔ 3 m	Acier inoxydable AISI 304	60 x 200	60252200	✓	6	2302	69,40/m
		60 x 300	60252300	✓	6	2302	87,72/m
		60 x 400	60252400	✓	6	2302	109,67/m
↔ 3 m	Acier inoxydable AISI 304	60 x 500	60252500	✓	6	2302	129,75/m
		60 x 600	60252600	✓	6	2302	147,44/m

Treillis à câbles

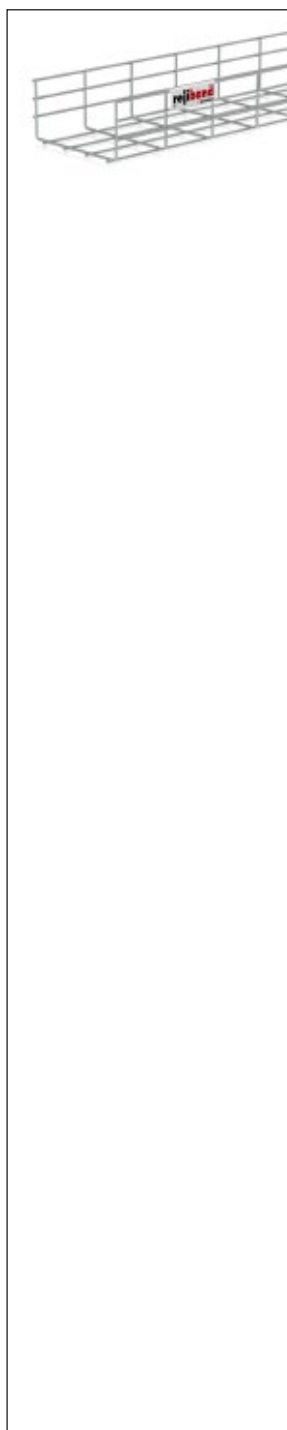

	type	référence	stock	page. catal.	groupe d'articles	prix en €	
Treillis à câbles Rejjiband 100							
Acier à zingage électrolytique							
↔ 3 m	12 m	100 x 100			2304	21,30/m	
		100 x 150	60213150		2304	26,14/m	
	6 m	100 x 200			2304	28,66/m	
		100 x 300	60213300		2304	34,30/m	
		100 x 400	60213400		2304	44,82/m	
		100 x 500	60213500		2304	53,82/m	
		100 x 600	60213600		2304	55,00/m	
Treillis à câbles Rejjiband 100							
Acier à zingage électrolytique, bichromaté							
↔ 3 m	12 m	100 x 100			2301	22,07/m	
		100 x 150	60223150		2301	27,07/m	
	6 m	100 x 200		✓ 6	2301	29,69/m	
		100 x 300	60223300		6	2301	35,53/m
		100 x 400	60223400	✓ 6	6	2301	46,44/m
		100 x 500	60223500		6	2301	55,75/m
		100 x 600	60223600		6	2301	56,98/m
Treillis à câbles Rejjiband 100							
Acier galvanisé à chaud							
↔ 3 m	12 m	100 x 100			2305	27,28/m	
		100 x 150	60233150		2305	30,32/m	
	6 m	100 x 200		6	2305	39,63/m	
		100 x 300	60233300		6	2305	50,43/m
		100 x 400	60233400		6	2305	61,53/m
		100 x 500	60233500		6	2305	71,79/m
		100 x 600	60233600		6	2305	76,65/m
Treillis à câbles Rejjiband 100							
Acier inoxydable AISI 304							
↔ 3 m	12 m	100 x 100			2302	63,89/m	
		100 x 150	60253150		2302	71,99/m	
	6 m	100 x 200		6	2302	91,11/m	
		100 x 300	60253300		6	2302	109,82/m
		100 x 400	60253400		6	2302	128,93/m
		100 x 500	60253500		6	2302	149,66/m
		100 x 600	60253600		6	2302	167,65/m

NEW

rejiband® RAPIDE

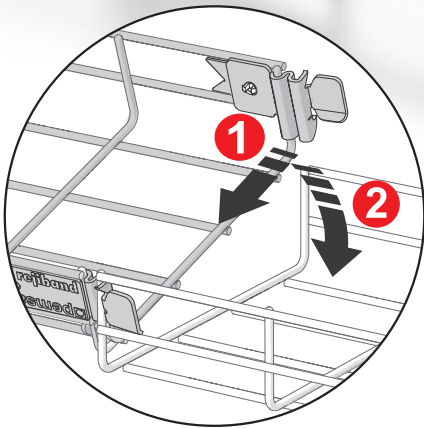
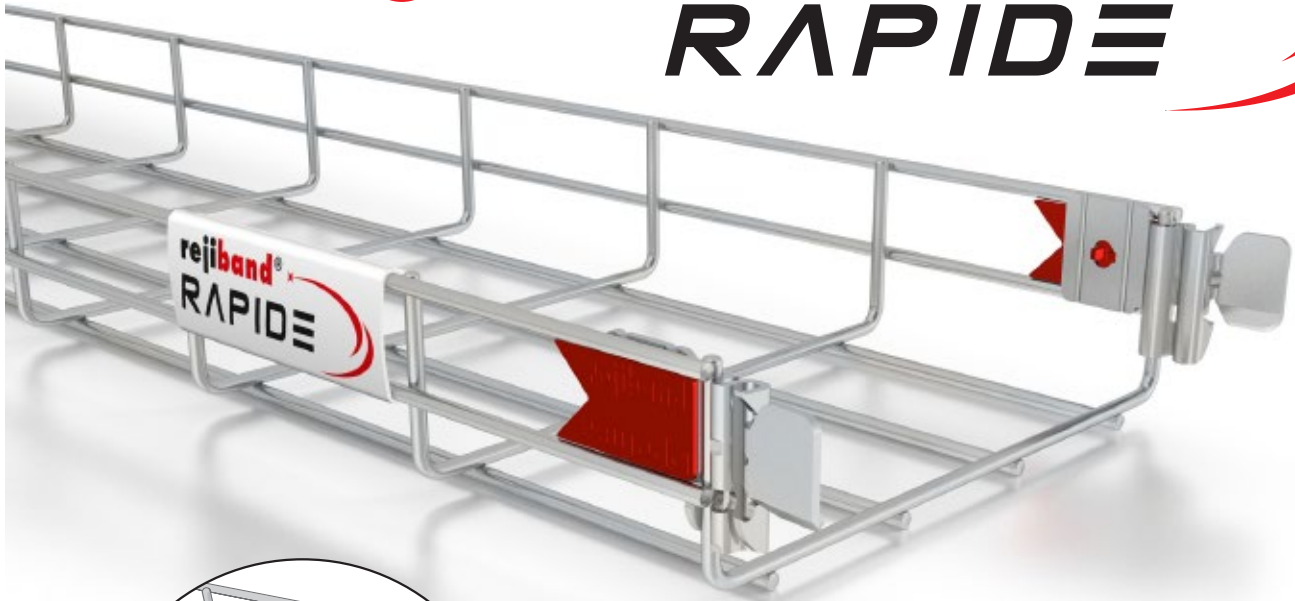

**Seulement
en 2 clicks**

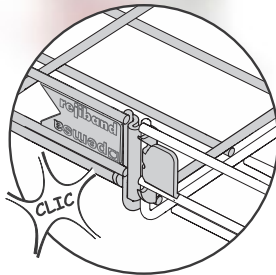

**Le système le
plus rapide**

Gain de temps & de main d'oeuvre, installation rapide

ASSEMBLAGE VERTICAL

MONTAGE BASCULANT

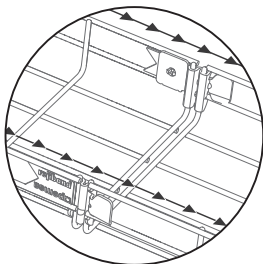

Continuité électrique
selon la norme

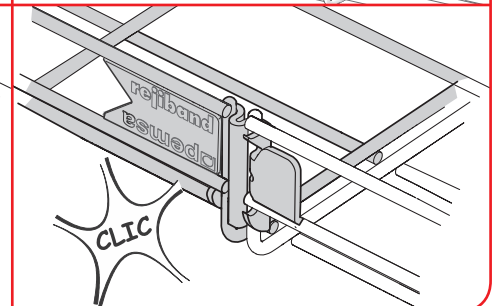
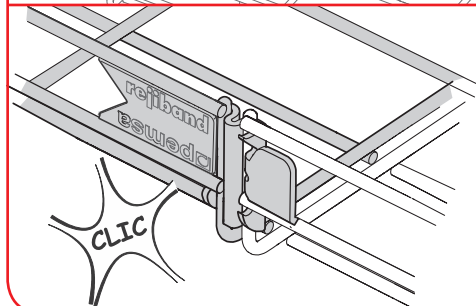
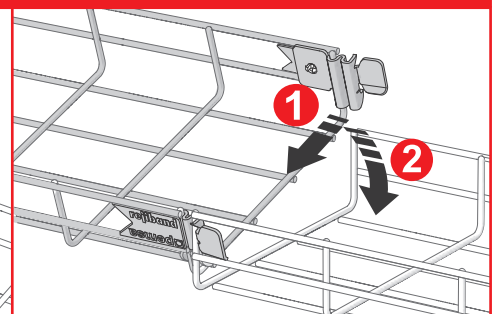
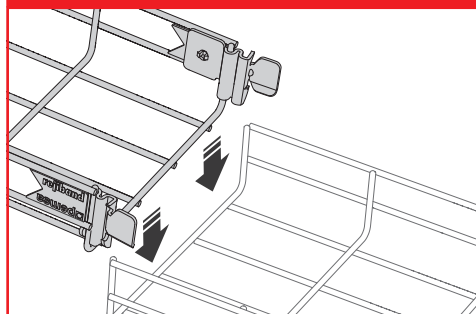



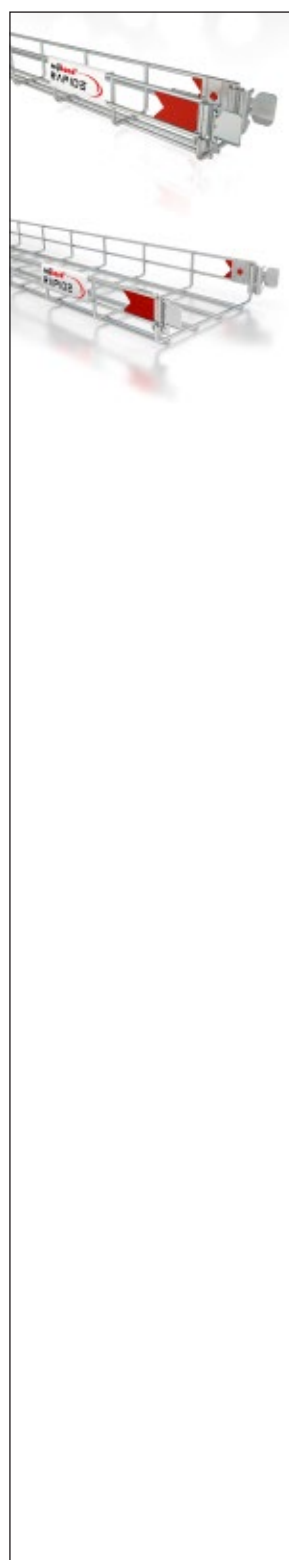

Treillis à câbles







Treillis à câbles Rejiband RAPIDE 60

Acier à zingage électrolytique

	type	référence	stock	page. catal.	groupe d'articles	prix en €
↔ 3 m	 18 m	60 x 60-2	60512060	✓	2304	8,96/m
		60 x 100	60512100	✓	2304	11,34/m
	 24 m	60 x 150	60512150	✓	2304	13,89/m
	 18 m	60 x 200	60512200	✓	2304	15,64/m
	 12 m	60 x 300	60512300	✓	2304	20,27/m
	 6 m	60 x 400	60512400	✓	2304	29,02/m
		60 x 500	60512500	✓	2304	35,74/m
		60 x 600	60512600	✓	2304	42,25/m



Treillis à câbles Rejiband RAPIDE 60

Acier à zingage électrolytique, bichromaté

↔ 3 m	 18 m	60 x 60-2	60522060	✓	2301	9,77/m
		60 x 100	60522100	✓	2301	12,57/m
	 24 m	60 x 150	60522150	✓	2301	15,40/m
	 18 m	60 x 200	60522200	✓	2301	17,36/m
	 12 m	60 x 300	60522300	✓	2301	22,41/m
	 6 m	60 x 400	60522400	✓	2301	31,98/m
		60 x 500	60522500		2301	39,64/m
		60 x 600	60522600		2301	46,65/m



Treillis à câbles Rejiband RAPIDE 100

Acier à zingage électrolytique













↔ 3 m	 12 m	100 x 100	60513100		2304	21,60/m
		100 x 150	60513150		2304	26,44/m
	 6 m	100 x 200	60513200		2304	28,68/m
		100 x 300	60513300		2304	34,47/m
		100 x 400	60513400		2304	44,87/m
		100 x 500	60513500		2304	53,33/m
		100 x 600	60513600		2304	54,27/m

Treillis à câbles Rejiband RAPIDE 100

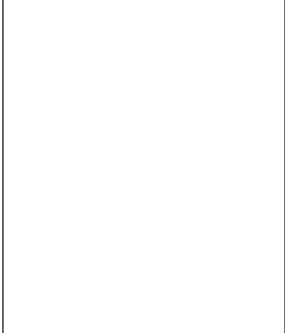
Acier à zingage électrolytique, bichromaté

↔ 3 m	 12 m	100 x 100	60523100		2301	22,10/m
		100 x 150	60523150		2301	27,03/m
	 6 m	100 x 200	60523200		2301	29,43/m
		100 x 300	60523300		2301	35,22/m
		100 x 400	60523400		2301	45,86/m
		100 x 500	60523500		2301	55,32/m
		100 x 600	60523600		2301	56,34/m











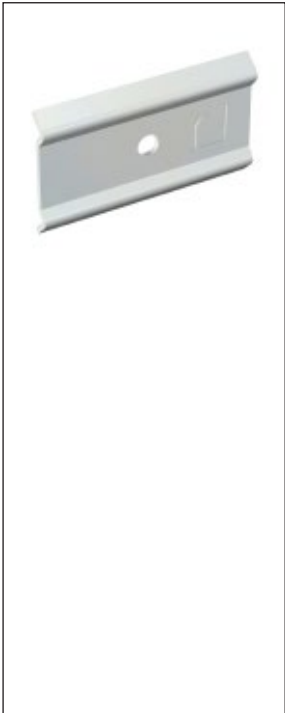



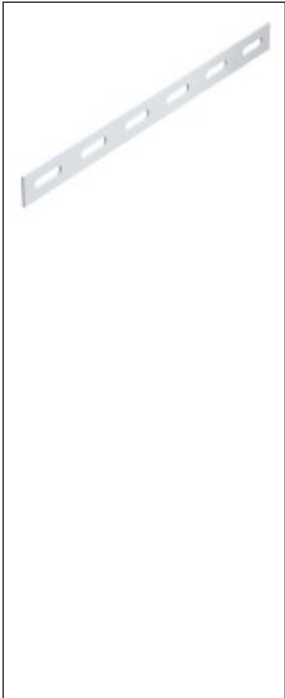

Treillis à câbles

	type	référence	📦 stock	page. catal.	groupe d'articles	prix en €	
	Accouplement latéral pour treillis à câbles Rejiband RAPIDE						
	Acier à zingage électrolytique	4	64010038	✓	2307	2,62/pc.	
 20 pc.	5	64010040	✓	2307	2,62/pc.		
	Accouplement latéral pour treillis à câbles Rejiband RAPIDE						
	Acier à zingage électrolytique,	4	64020038	✓	2307	2,90/pc.	
 20 pc.	bichromaté	5	64020040	✓	2307	2,90/pc.	
	Accouplement de fond pour treillis à câbles Rejiband RAPIDE						
	Acier à zingage électrolytique	4	64010046	✓	2307	3,93/pc.	
 20 pc.	5	64010048	✓	2307	3,93/pc.		
	Accouplement de fond pour treillis à câbles Rejiband RAPIDE						
	Acier à zingage électrolytique,	4	64020046	✓	2307	4,28/pc.	
 20 pc.	bichromaté	5	64020048	✓	2307	4,28/pc.	
	Accouplement renforcé 61						
	Acier à zingage électrolytique		64010061	✓	2307	1,55/pc.	
	 50 pc.						
	Accouplement renforcé 61						
	Acier à zingage électrolytique, bichromaté		64020061	✓	7	2307	1,55/pc.
	 50 pc.						
Accouplement renforcé 61							
Acier galvanisé à chaud		64030061	✓	7	2307	2,19/pc.	
 50 pc.							
Accouplement renforcé 61							
Black C8		64080061	✓		2307	2,19/pc.	
 50 pc.							
Accouplement renforcé 61							
Acier inoxydable AISI 316		64060061	✓	7	2307	6,38/pc.	
 50 pc.							

Treillis à câbles

	type	référence	stock	page. catal.	groupe d'articles	prix en €
	Accouplement Click					
	Acier à zingage électrolytique	64010035			2307	2,32/pc.
	 50 pc.					
	Accouplement Click					
Acier à zingage électrolytique, bichromaté	64020035		7	2307	2,32/pc.	
 50 pc.						
Accouplement Click						
Acier galvanisé à chaud	64030035		✓	7	2307	3,25/pc.
 50 pc.						
Accouplement Click						
Black C8	64080035				2307	3,25/pc.
 50 pc.						
	Accouplement de fond Click					
	Acier à zingage électrolytique	64010036			2307	3,31/pc.
	 10 pc.					
	Accouplement de fond Click					
Acier à zingage électrolytique, bichromaté	64020036		7	2307	3,31/pc.	
 10 pc.						
Accouplement de fond Click						
Acier galvanisé à chaud	64030036		✓	7	2307	4,63/pc.
 10 pc.						
Accouplement de fond Click						
Black C8	64080036				2307	4,63/pc.
 10 pc.						
	Accouplement Click					
	Acier à zingage électrolytique	64010020		✓	2307	4,13/pc.
	 25 pc.					
	Accouplement Click					
Acier à zingage électrolytique, bichromaté	64020030		✓	7	2307	4,13/pc.
 25 pc.						
Accouplement Click						
Acier galvanisé à chaud	64030030		7	2307	4,93/pc.	
 25 pc.						
Accouplement Click						
Black C8	64080030		✓		2307	4,93/pc.
 25 pc.						

Treillis à câbles

	type	référence	stock	page. catal.	groupe d'articles	prix en €
	Accouplement au flanc 41					
	Acier à zingage électrolytique	64010041	✓		2307	1,47/pc.
	 50 pc.					
	Accouplement au flanc 41					
	Acier à zingage électrolytique, bichromaté	64020041	✓	9	2307	1,47/pc.
 50 pc.						
Accouplement au flanc 41						
Acier galvanisé à chaud	64030041	✓	9	2307	2,33/pc.	
 50 pc.						
Accouplement au flanc 41						
Black C8	64080041	✓		2307	2,33/pc.	
 50 pc.						
Accouplement au flanc 41						
Acier inoxydable AISI 316	64060041	✓	9	2307	7,99/pc.	
 50 pc.						
	Multi-éclisse					
	Acier à zingage électrolytique L = 300 mm	67010053	✓		2307	4,50/pc.
	 10 pc.					
	Multi-éclisse					
	Acier à zingage électrolytique, bichromaté L = 300 mm	67020053	✓	9	2307	4,50/pc.
 10 pc.						
Multi-éclisse						
Acier galvanisé à chaud L = 300 mm	67030047	✓	9	2307	7,22/pc.	
 10 pc.						
Multi-éclisse						
Black C8 L = 300 mm	67080053	✓		2307	7,22/pc.	
 10 pc.						
Multi-éclisse						
Acier inoxydable AISI 316 L = 300 mm	67060053		9	2307	13,32/pc.	
 10 pc.						
	Borne de terre					
	Cuivre 16-35 mm ²	68000032	✓	10	2307	9,46/pc.
 20 pc.						
	Borne de terre					
	Cuivre 16-50 mm ²	68000034	✓	10	2309	5,95/pc.
 20 pc.						

Treillis à câbles



Accouplement 60

Acier à zingage électrolytique 64010060 ✓ 2307 1,14/pc.

50 pc.

Accouplement 60

Acier à zingage électrolytique, bichromaté 64020060 ✓ 8 2307 1,14/pc.

50 pc.

Accouplement 60

Acier galvanisé à chaud 64030060 ✓ 8 2307 1,72/pc.

50 pc.

Accouplement 60

Black C8 64080060 ✓ 2307 1,72/pc.

50 pc.

Accouplement 60

Acier inoxydable AISI 316 64060060 ✓ 8 2307 4,37/pc.

50 pc.



Plaque d'accouplement 62

Acier à zingage électrolytique 64010062 ✓ 2307 0,62/pc.

50 pc.

Plaque d'accouplement 62

Acier à zingage électrolytique, bichromaté 64020062 ✓ 8 2307 0,62/pc.

50 pc.

Plaque d'accouplement 62

Acier galvanisé à chaud 64030062 ✓ 8 2307 0,65/pc.

50 pc.

Plaque d'accouplement 62

Acier inoxydable AISI 316 64060062 ✓ 8 2307 2,29/pc.

50 pc.



Accouplement courbe Click

Acier à zingage électrolytique 64010072 2307 1,41/pc.

50 pc.

Accouplement courbe Click

Acier à zingage électrolytique, bichromaté 64020072 8 2307 1,41/pc.

50 pc.

Accouplement courbe Click

Acier galvanisé à chaud 64030072 8 2307 1,94/pc.

50 pc.

Accouplement courbe Click

Black C8 64080072 2307 1,94/pc.

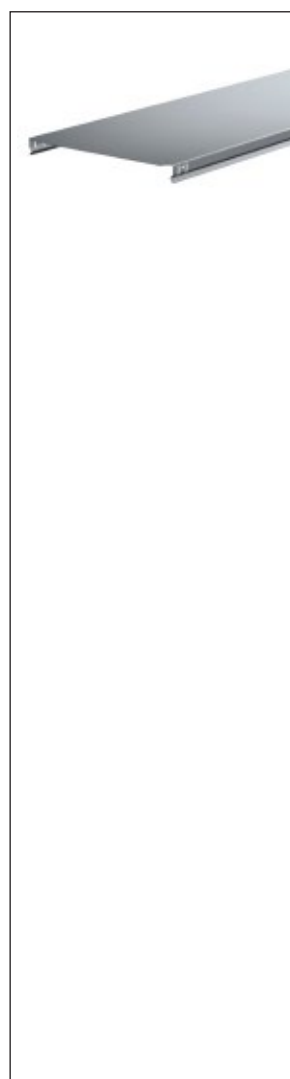

50 pc.

Treillis à câbles





Couvercle Click

Acier galvanisé Sendzimir

	type	référence	stock	page. catal.	groupe d'articles	prix en €	
↔ 3 m	 24 m	60	73021060	✓	6	2316	7,08/m
		100	73021100	✓	6	2316	9,14/m
	 12 m	150	73021150	✓	6	2316	11,84/m
		200	73021200	✓	6	2316	14,42/m
	 6 m	300	73021300	✓	6	2316	21,99/m
		400	73021400		6	2316	28,17/m
		500	73021500		6	2316	38,16/m
		600	73021600		6	2316	44,78/m



Couvercle Click

Acier galvanisé à chaud

↔ 3 m	 24 m	60	73031060	✓	6	2316	11,86/m
		100	73031100	✓	6	2316	16,55/m
	 12 m	150	73031150	✓	6	2316	22,50/m
		200	73031200	✓	6	2316	28,47/m
	 6 m	300	73031300	✓	6	2316	43,30/m
		400	73031400		6	2316	56,07/m
		500	73031500		6	2316	68,84/m
		600	73031600		6	2316	81,62/m

Couvercle Click

Acier inoxydable AISI 304

↔ 3 m	 24 m	60	73051060	✓	6	2316	29,81/m
		100	73051100	✓	6	2316	42,12/m
	 12 m	150	73051150	✓	6	2316	56,19/m
		200	73051200	✓	6	2316	68,81/m
	 6 m	300	73051300	✓	6	2316	96,18/m
		400	73051400		6	2316	124,16/m
		500	73051500		6	2316	135,10/m
		600	73051600		6	2316	185,28/m

Cloison de séparation H = 25 mm

Acier galvanisé Sendzimir

↔ 3 m	 60 m	67020610	✓	10	2316	7,05/m
-------	--	----------	---	----	------	--------

Cloison de séparation H = 25 mm

Acier galvanisé à chaud



















↔ 3 m	 60 m	67030610	✓	10	2316	9,67/m
-------	--	----------	---	----	------	--------

Cloison de séparation H = 25 mm



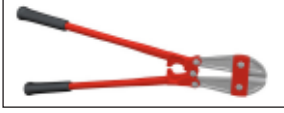







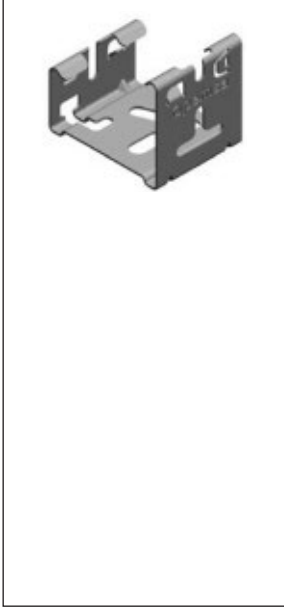

Acier inoxydable AISI 316

↔ 3 m	 60 m	67060610		10	2316	32,35/m
-------	--	----------	--	----	------	---------











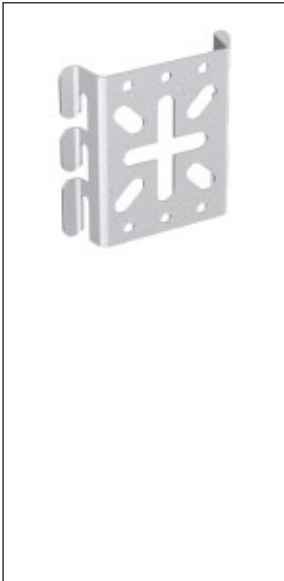

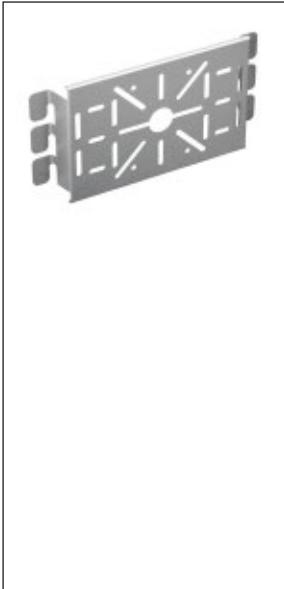

Treillis à câbles

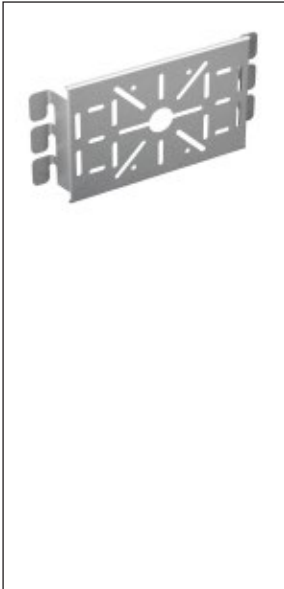
	type	référence	stock	page. catal.	groupe d'articles	prix en €
	Cloison de séparation, H = 50 mm					
	Acier galvanisé Sendzimir	67020611	✓	10	2316	7,92/m
	↔ 3 m  48 m					
	Cloison de séparation, H = 50 mm					
	Acier galvanisé à chaud	67030611	✓	10	2316	13,13/m
	↔ 3 m  48 m					
	Cloison de séparation, H = 50 mm					
	Acier inoxydable AISI 316	67060611		10	2316	43,58/m
	↔ 3 m  48 m					
	Cloison de séparation, H = 80 mm					
	Acier galvanisé Sendzimir	67020612		10	2316	13,93/m
	↔ 3 m  36 m					
	Cloison de séparation, H = 80 mm					
	Acier galvanisé à chaud	67030612		10	2316	18,49/m
	↔ 3 m  36 m					
	Cloison de séparation, H = 80 mm					
	Acier inoxydable AISI 316	67060612		10	2316	57,04/m
	↔ 3 m  36 m					
	Plaque d'identification					
	Matière synthétique rouge	68000020		10	2307	1,17/pc.
	 50 pc.					
	Cisaille pour treillis à câbles					
	450x140	68000058	✓	8	2307	313,25/pc.
	Embout de finition					
	Matière synthétique noir	68000049	✓	9	2307	0,45/pc.
	 100 pc.					
	Galvanospray 0,4l					
	Zinc	68000052	✓	9	2307	56,99/pc.
	Galvanospray 0,4l					
Black C8	68000053	✓		2307	98,00/pc.	

Treillis à câbles

	type	référence	stock	page. catal.	groupe d'articles	prix en €
	Support pour boîte de montage					
	Matière synthétique rouge	68000040		20	2307	1,42/pc.
	 20 pc.					
	Etrier pour éclairage ou boîte de distribution					
	Acier à zingage électrolytique	67010030			2307	8,60/pc.
	 10 pc.					
	Etrier pour éclairage ou boîte de distribution					
	Acier à zingage électrolytique, bichromaté	67020030		20	2307	8,60/pc.
 10 pc.						
Etrier pour éclairage ou boîte de distribution						
Acier galvanisé à chaud	67030030		20	2307	9,46/pc.	
 10 pc.						
Etrier pour éclairage ou boîte de distribution						
Black C8	67080030			2307	9,46/pc.	
 10 pc.						
	Bande auto-adhésive Rejifix					
	ABS noir	89011000		20	2307	140,93/pc.
1 pc. = 25 m						
	Support pour câbles					
	ABS rouge	68000010		20	2307	2,03/pc.
 20 pc.						
	Plaquette d'identification					
	Polypropylène	89010000		21	2307	1,30/pc.
 20 pc.						









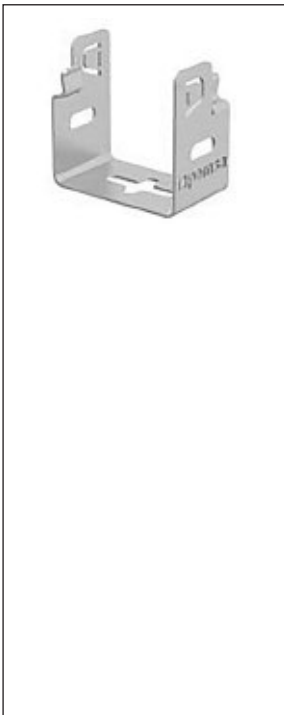

Treillis à câbles

	type	référence	stock	page. catal.	groupe d'articles	prix en €	
	Mini-support universel						
	Acier galvanisé Sendzimir	87x65	62026010	✓	13	2307	3,27/pc.
	 10 pc.						
	Mini-support universel						
	Acier galvanisé à chaud	87x65	62036010	✓	13	2307	7,02/pc.
	 10 pc.						
	Mini-support universel						
	Black C8	87x65	62086010	✓		2307	7,02/pc.
 10 pc.							
	Mini-support universel						
	Acier inoxydable AISI 316	87x65	62066010	✓	13	2307	12,42/pc.
	 10 pc.						
	Plaque de montage						
	Acier galvanisé Sendzimir	109x170	62026011	✓	13	2307	6,09/pc.
	 10 pc.						
	Plaque de montage						
	Acier galvanisé à chaud	109x170	62036011	✓	13	2307	10,70/pc.
 10 pc.							
	Plaque de montage						
	Black C8	109x170	62086011			2307	10,70/pc.
	 10 pc.						
	Plaque de montage						
Acier inoxydable AISI 316	109x170	62066011		13	2307	26,03/pc.	
 10 pc.							
	Sortie pour câbles optiques						
	Matière synthétique rouge		67020039	✓	21	2307	4,22/pc.
 10 pc.							
	Sortie pour câbles						
	Acier galvanisé Sendzimir		67010016			2307	7,78/pc.
Sortie pour câbles							
Acier galvanisé à chaud		67030016			2307	12,99/pc.	

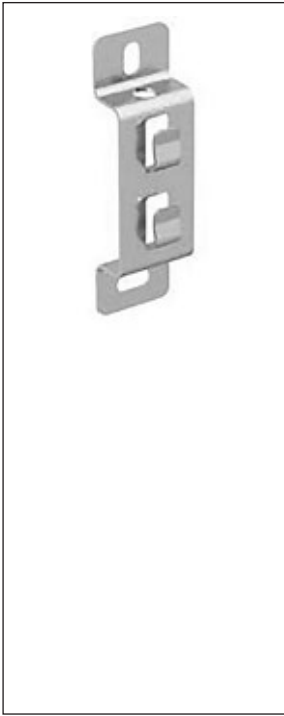
Treillis à câbles

	type	référence	stock	page. catal.	groupe d'articles	prix en €
	Etrier avec sorties pour tubes					
	Acier à zingage électrolytique	67010040			2307	4,82/pc.
	 10 pc.					
	Etrier avec sorties pour tubes					
	Acier à zingage électrolytique, bichromaté	67020040		21	2307	4,82/pc.
	 10 pc.					
	Etrier avec sorties pour tubes					
	Black C8	67080040			2307	6,86/pc.
	 10 pc.					
	Etrier mural léger					
	Acier à zingage électrolytique	62016021	✓		2307	1,82/pc.
	 25 pc.					
	Etrier mural léger					
	Acier à zingage électrolytique, bichromaté	62026021	✓	15	2307	1,82/pc.
	 25 pc.					
	Etrier mural léger					
	Acier galvanisé à chaud	62036021	✓	15	2307	3,04/pc.
	 25 pc.					
	Etrier mural léger					
	Black C8	62086021	✓		2307	3,04/pc.
	 25 pc.					
	Etrier de plafond léger					
	Acier à zingage électrolytique	62016020			2307	7,31/pc.
	 10 pc.					
	Etrier de plafond léger					
	Acier à zingage électrolytique, bichromaté	62026020	✓	15	2307	7,31/pc.
	 10 pc.					
	Etrier de plafond léger					
	Acier galvanisé à chaud	62036020		15	2307	10,88/pc.
	 10 pc.					
	Etrier de plafond léger					
	Black C8	62086020			2307	10,88/pc.
	 10 pc.					

Treillis à câbles

	type	référence	stock	page. catal.	groupe d'articles	prix en €	
	Support de fond 60						
	Acier à zingage électrolytique	100x63	62016022		2307	6,02/pc.	
	 10 pc.						
	Support de fond 60						
	Acier à zingage électrolytique, bichromaté	100x63	62026022	✓	15	2307	6,02/pc.
 10 pc.							
Support de fond 60							
Acier galvanisé à chaud	100x63	62036022	✓	15	2307	8,02/pc.	
Support de fond 60							
Black C8	100x63	62086022			2307	8,02/pc.	
 10 pc.							
Support de fond 60							
Acier inoxydable AISI 316	100x63	62066022		15	2307	15,81/pc.	
 10 pc.							
	Support pour flanc 60						
	Acier à zingage électrolytique	104x30	62011060	✓		2307	3,13/pc.
	 25 pc.						
	Support pour flanc 60						
	Acier à zingage électrolytique, bichromaté	104x30	62021060	✓	14	2307	3,13/pc.
	 25 pc.						
	Support pour flanc 60						
Acier galvanisé à chaud	104x30	62031060	✓	14	2307	4,20/pc.	
 25 pc.							
Support pour flanc 60							
Black C8	104x30	62081060	✓		2307	4,20/pc.	
 25 pc.							
Support pour flanc 60							
Acier inoxydable AISI 316	104x30	62061060	✓	14	2307	7,52/pc.	
 25 pc.							
	Accouplement pour treillis / profilé						
	Acier galvanisé à chaud		67030049	✓	21	2307	2,55/pc.
 50 pc.							

Treillis à câbles



Suspension centrale Click

Acier à zingage électrolytique



type	référence	stock	page. catal.	groupe d'articles	prix en €
M6	67010143	✓		2307	3,88/pc.
M8/M10	67010043	✓		2307	3,88/pc.

Suspension centrale Click

Acier à zingage électrolytique, bichromaté



M6	67020143	✓	14	2307	3,88/pc.
M8/M10	67020043	✓	14	2307	3,88/pc.

Suspension centrale Click

Acier galvanisé à chaud



M6	67030143		14	2307	4,84/pc.
M8/M10	67030043		14	2307	4,84/pc.

Suspension centrale Click

Black C8



M6	67080143	✓		2307	4,84/pc.
M8/M10	67080043			2307	4,84/pc.

Suspension centrale Click

Acier inoxydable AISI 316



M6	67060143	✓	14	2307	9,07/pc.
M8/M10	67060043		14	2307	9,07/pc.

Suspension centrale

Acier à zingage électrolytique



M6	67010144			2307	1,51/pc.
M8/M10	67010046	✓		2307	1,31/pc.

Suspension centrale

Acier à zingage électrolytique, bichromaté



M8/M10	67020046	✓	14	2307	1,31/pc.
--------	----------	---	----	------	----------

Suspension centrale

Acier galvanisé à chaud



M8/M10	67030046	✓	14	2307	2,24/pc.
--------	----------	---	----	------	----------

Suspension centrale

Black C8



M8/M10	67080046	✓		2307	2,24/pc.
--------	----------	---	--	------	----------

Suspension centrale







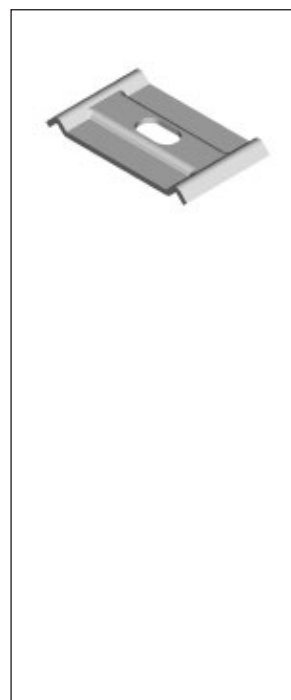





Acier inoxydable AISI 316

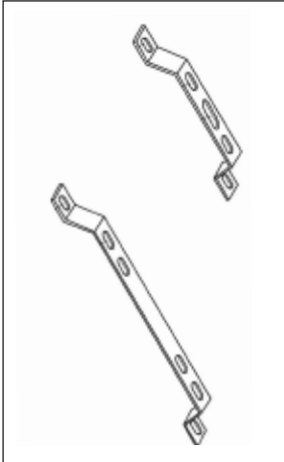

M8/M10	67060046	✓	14	2307	3,43/pc.
--------	----------	---	----	------	----------

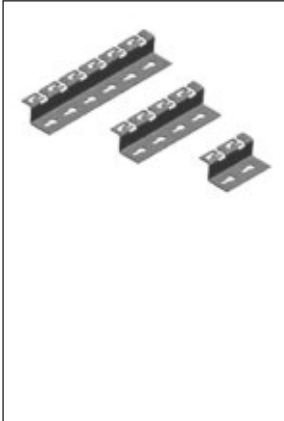

Treillis à câbles

	type	référence	stock	page. catal.	groupe d'articles	prix en €	
	Pied d'appui						
	Matière synthétique rouge  100 pc. Hauteur 40 mm empilable.	68000060	✓	12	2307	2,97/pc.	
	Adhésif pour pied (2 x 4 kg)						
	Adhésif + durcisseur suffisant pour env. 400 pieds d'appui.	68000066		12	2307	330,54/pc.	
	Roofsupport						
	Matière synthétique/béton 1 set = 20 supports	60102011RSC	✓		2307	305,20/bt.	
	Distanceur						
	Acier galvanisé Sendzimir  10 pc.	180 350	67030539 67030540	✓ ✓	12 12	2307 2307	8,08/pc. 10,15/pc.
	Distanceur						
	Acier galvanisé à chaud  10 pc.	180 350	67030541 67030542	✓	12 12	2307 2307	14,32/pc. 16,47/pc.
Distanceur							
Acier inoxydable AISI 316  10 pc.	180 350	67060541 67060542	✓	12 12	2307 2307	40,11/pc. 54,91/pc.	
	RPLUS distanceur Click						
	Acier galvanisé Sendzimir  10 pc.	100 200 300	67020520 67020522 67020524	✓ ✓ ✓	17 17 17	2307 2307 2307	7,83/pc. 9,36/pc. 10,76/pc.
	RPLUS distanceur Click						
	Acier galvanisé à chaud  10 pc.	100 200 300	67030520 67030522 67030524	✓ ✓ ✓	17 17 17	2307 2307 2307	9,71/pc. 12,35/pc. 14,86/pc.
	RPLUS distanceur Click						
	Acier inoxydable AISI 304  10 pc.	100 200 300	67050520 67050522 67050524	✓ ✓ ✓	17 17 17	2307 2307 2307	12,10/pc. 19,97/pc. 27,49/pc.

rejiband® BLACK C8®

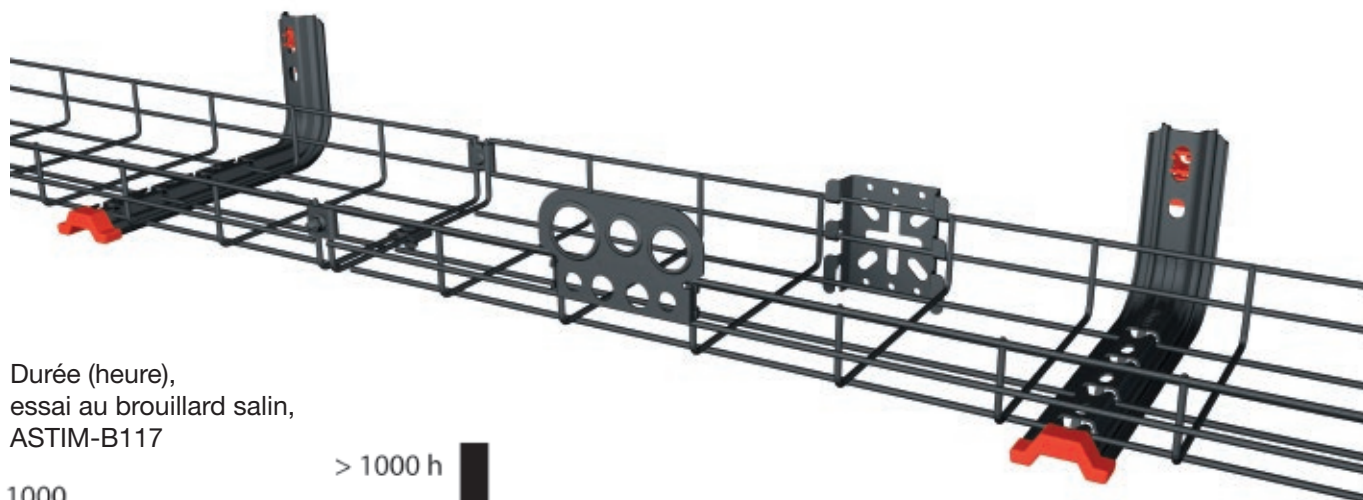

Durée (heure),
essai au brouillard salin,
ASTIM-B117

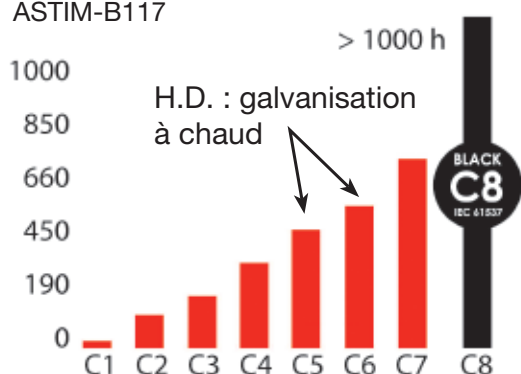

- ✓ une protection élevée contre la corrosion
- ✓ une finition esthétique de haute qualité – un revêtement lisse et régulier

- ✓ libre de membranes de zinc et de particules de zinc libres
- ✓ écologique



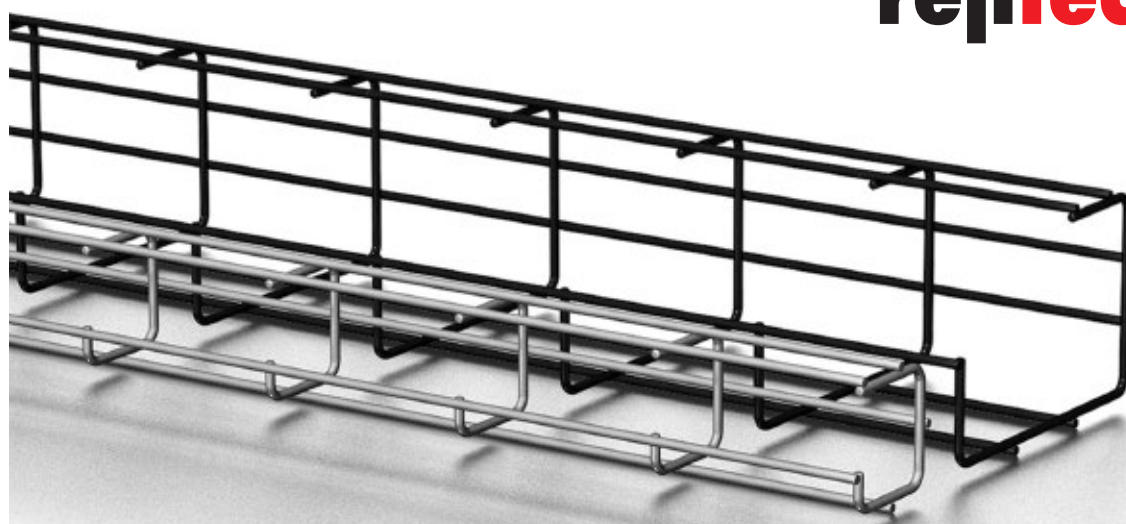





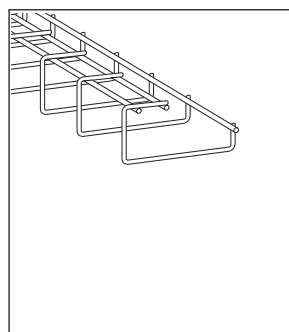





rejitech® G+















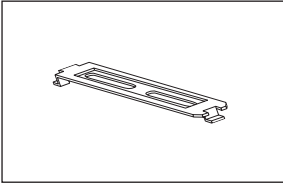

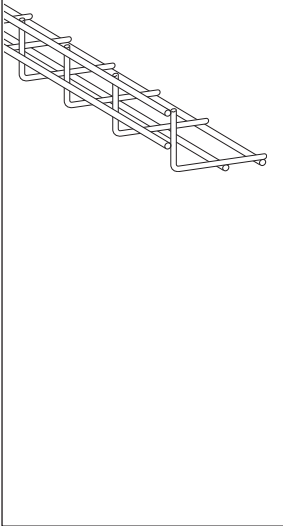

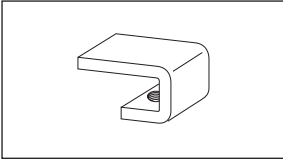
- ✓ installation rapide avec étrier
- ✓ directement au plafond
- ✓ pas besoin des étriers en C

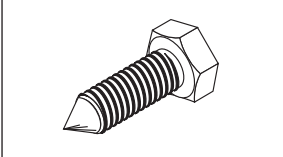
Treillis de plafond et treillis angulaire

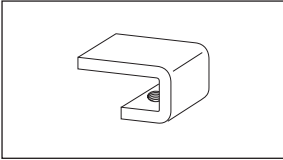

	type	référence	stock	page. catal.	groupe d'articles	prix en €	
Treillis de plafond Rejitech							
	Acier à zingage électrolytique	60 x 100	60215020	✓	2304	16,31/m	
	↔ 2 m	 16 m					
Treillis de plafond Rejitech							
	Acier à zingage électrolytique, bichromaté	60 x 100	60225020	✓	6	2301	16,90/m
	↔ 2 m	 16 m					
Treillis de plafond Rejitech G+							
	Acier à zingage électrolytique						
	↔ 3 m	 24 m	60 x 60 100 x 60	60613206 60613306	✓ ✓	2304 2304	15,28/m 17,90/m
		 12 m	100 x 100	60613310	✓	2304	22,32/m
		 6 m	100 x 150 100 x 200	60613315 60613320	✓ ✓	2304 2304	24,27/m 28,84/m
Treillis de plafond Rejitech G+							
	Acier à zingage électrolytique, bichromaté						
	↔ 3 m	 24 m	60 x 60 100 x 60	60623206 60623306		2301 2301	16,30/m 19,09/m
		 12 m	100 x 100	60623310		2301	23,82/m
		 6 m	100 x 150 100 x 200	60623315 60623320		2301 2301	25,93/m 30,74/m
Treillis de plafond Rejitech G+							
	Acier galvanisé à chaud						
	↔ 3 m	 24 m	60 x 60 100 x 60	60633206 60633306		2305 2305	23,36/m 28,48/m
		 12 m	100 x 100	60633310		2305	33,60/m
		 6 m	100 x 150 100 x 200	60633315 60633320		2305 2305	35,85/m 44,08/m
Treillis de plafond Rejitech G+							
	Black C8						
	↔ 3 m	 24 m	60 x 60 100 x 60	60683206 60683306		2306 2306	20,56/m 25,07/m
		 12 m	100 x 100	60683310	✓	2306	29,57/m
		 6 m	100 x 150 100 x 200	60683315 60683320		2306 2306	31,51/m 38,80/m

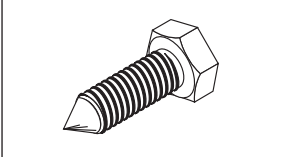
Treillis de plafond et treillis angulaire

	type	référence	stock	page. catal.	groupe d'articles	prix en €
	Etrier pour treillis de plafond Rejitech et Rejitech G+					
	Acier à zingage électrolytique	67010052	✓		2307	1,99/pc.
	 25 pc.					
	Etrier pour treillis de plafond Rejitech et Rejitech G+					
	Acier à zingage électrolytique, bichromaté	67020052	✓	11	2307	1,99/pc.
	 25 pc.					
	Etrier pour treillis de plafond Rejitech et Rejitech G+					
	Acier galvanisé à chaud	67030252	✓	11	2307	2,72/pc.
	 25 pc.					
	Etrier pour treillis de plafond Rejitech et Rejitech G+					
	Black C8	67080252	✓	11	2307	2,72/pc.
	 25 pc.					
	Support pour boîte de montage pour treillis de plafond Rejitech					
	Acier à zingage électrolytique, bichromaté	67020041	✓	11	2307	13,54/pc.
	 10 pc.					
	Treillis angulaire					
	Acier à zingage électrolytique, bichromaté	60 x 109 60220000	✓	6	2301	13,42/m
	↔ 3 m  18 m					
	Treillis angulaire					
	Acier galvanisé à chaud	60 x 109 60230000		6	2305	16,62/m
↔ 3 m  18 m						
Treillis angulaire						
Acier inoxydable AISI 304	60 x 109 60250000		6	2302	30,97/m	
↔ 3 m  18 m						
	Etrier pour treillis angulaire					
	Acier à zingage électrolytique, bichromaté	67020051	✓	13	2307	9,77/pc.
	 10 pc.					
	Vis hexagonale à pointe conique					
	Acier à zingage électrolytique, bichromaté	M10x20 67020098	✓	13	2307	1,79/pc.
	 10 pc.					

Systemes de suspension – treillis à câbles



SPLUS console Oméga Click

	type	référence	stock	page. catal.	groupe d'articles	prix en €	
 5 pc.	Acier galvanisé Sendzimir	100	62021104	✓	18	2307	6,29/pc.
		150	62021154	✓	18	2307	8,13/pc.
		200	62021204	✓	18	2307	9,31/pc.
		300	62021304	✓	18	2307	10,98/pc.
		400	62021404	✓	18	2307	16,42/pc.

SPLUS onsole Oméga Click

 5 pc.	Acier galvanisé à chaud	100	62031104	✓	18	2307	9,63/pc.
		150	62031154		18	2307	12,32/pc.
		200	62031204	✓	18	2307	13,20/pc.
		300	62031304	✓	18	2307	14,12/pc.
		400	62031404		18	2307	21,79/pc.

SPLUS console Oméga Click

 5 pc.	Black C8	100	62081104	✓		2307	9,63/pc.
		150	62081154			2307	12,32/pc.
		200	62081204	✓		2307	13,20/pc.
		300	62081304	✓		2307	14,12/pc.
		400	62081404			2307	21,79/pc.

SPLUS console Oméga Click

 5 pc.	Acier inoxydable AISI 304	100	62051104		18	2307	19,90/pc.
		150	62051154		18	2307	24,69/pc.
		200	62051204		18	2307	31,06/pc.
		300	62051304		18	2307	37,64/pc.
		400	62051404		18	2307	45,79/pc.

SPLUS étrier en C Oméga Click

 4 pc.	Acier galvanisé Sendzimir	100	62022104	✓	18	2307	12,42/pc.
		150	62022154	✓	18	2307	13,05/pc.
		200	62022204	✓	18	2307	14,03/pc.
		300	62022304	✓	18	2307	16,42/pc.
		400	62022404	✓	18	2307	24,23/pc.

SPLUS étrier en C Oméga Click

 4 pc.	Acier galvanisé à chaud	100	62032104	✓	18	2307	16,42/pc.
		150	62032154		18	2307	18,06/pc.
		200	62032204	✓	18	2307	20,16/pc.
		300	62032304	✓	18	2307	24,16/pc.
		400	62032404		18	2307	36,94/pc.

SPLUS étrier en C Oméga Click

 4 pc.	Black C8	100	62082104	✓		2307	16,42/pc.
		150	62082154			2307	18,06/pc.
		200	62082204	✓		2307	20,16/pc.
		300	62082304	✓		2307	24,16/pc.
		400	62082404			2307	36,94/pc.

SPLUS étrier en C Oméga Click

 4 pc.	Acier inoxydable AISI 304	100	62052104		18	2307	33,97/pc.
		150	62052154		18	2307	36,84/pc.
		200	62052204		18	2307	48,44/pc.
		300	62052304		18	2307	55,65/pc.
		400	62052404		18	2307	64,31/pc.



Systemes de suspension – treillis à câbles

	type	référence	stock	page. catal.	groupe d'articles	prix en €	
	RPLUS console Click						
	Acier galvanisé Sendzimir	100	62025103	✓	17	2307	7,86/pc.
	 4 pc.	150	62025153	✓	17	2307	9,17/pc.
		200	62025203	✓	17	2307	10,55/pc.
		300	62025303	✓	17	2307	12,08/pc.
		400	62025403		17	2307	17,44/pc.
		500	62025503		17	2307	20,24/pc.
600		62025603		17	2307	23,03/pc.	
	RPLUS console Click						
	Acier galvanisé à chaud	100	62035103	✓	17	2307	12,14/pc.
	 4 pc.	150	62035153	✓	17	2307	13,57/pc.
		200	62035203	✓	17	2307	16,03/pc.
		300	62035303	✓	17	2307	19,85/pc.
		400	62035403	✓	17	2307	22,20/pc.
		500	62035503		17	2307	27,68/pc.
600		62035603		17	2307	32,21/pc.	
	RPLUS console Click						
	Black C8	100	62085103	✓		2307	12,14/pc.
	 4 pc.	150	62085153			2307	13,57/pc.
		200	62085203	✓		2307	16,03/pc.
		300	62085303	✓		2307	19,85/pc.
		400	62085403			2307	22,20/pc.
		500	62085503			2307	27,68/pc.
600		62085603			2307	32,21/pc.	
	RPLUS console						
	Acier inoxydable AISI 304	100	62055103	✓	17	2307	27,32/pc.
	 4 pc.	150	62055153	✓	17	2307	30,12/pc.
		200	62055203	✓	17	2307	33,69/pc.
		300	62055303	✓	17	2307	40,90/pc.
	 4 pc.	400	62055403	✓	17	2307	68,52/pc.
		500	62055503	✓	17	2307	77,33/pc.
600		62055603	✓	17	2307	87,86/pc.	
Kit embout étrier réglable							
Acier galvanisé à chaud		62037002		17	2307	19,53/pc.	
 4 pc.							
Kit embout étrier réglable							
Acier inoxydable AISI 304		62057002		17	2307	sur demande	

Systemes de suspension – treillis à câbles

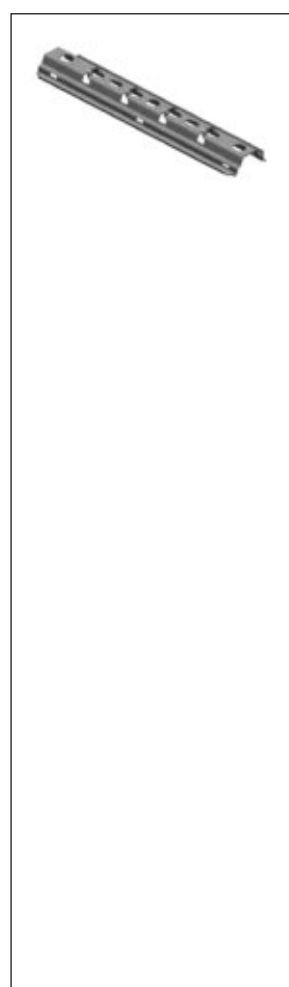

SPLUS console Oméga Click

	type	référence	stock	page. catal.	groupe d'articles	prix en €	
 10 pc.	Acier galvanisé Sendzimir	100	63022104	✓	18	2307	4,26/pc.
		150	63022154	✓	18	2307	4,70/pc.
		200	63022204	✓	18	2307	5,90/pc.
		300	63022304	✓	18	2307	6,94/pc.
		400	63022404	✓	18	2307	9,38/pc.
		500	63022504	✓	18	2307	10,57/pc.
		600	63022604	✓	18	2307	13,97/pc.

SPLUS console Oméga Click

 10 pc.	Acier galvanisé à chaud	100	63032104		18	2307	7,08/pc.
		150	63032154		18	2307	7,57/pc.
		200	63032204		18	2307	9,26/pc.
		300	63032304		18	2307	11,11/pc.
		400	63032404		18	2307	13,49/pc.
		500	63032504		18	2307	15,93/pc.
		600	63032604		18	2307	19,06/pc.

SPLUS console Oméga Click

 10 pc.	Black C8	100	63082104	✓	18	2307	9,02/pc.
		150	63082154		18	2307	9,15/pc.
		200	63082204	✓	18	2307	9,26/pc.
		300	63082304	✓	18	2307	11,11/pc.
		400	63082404		18	2307	13,49/pc.
		500	63082504		18	2307	15,93/pc.
		600	63082604		18	2307	19,06/pc.

SPLUS console Oméga Click

 10 pc.	Acier inoxydable AISI 304	100	63052104	-	2307	13,53/pc.
		150	63052154	-	2307	16,34/pc.
		200	63052204	-	2307	18,95/pc.
		300	63052304	-	2307	23,67/pc.
		400	63052404	-	2307	30,11/pc.
		500	63052504	-	2307	36,77/pc.
		600	63052604	-	2307	44,60/pc.



SPLUS profilé Oméga Click

	Acier galvanisé Sendzimir						
	↔ 1 m		67020110		18	2307	28,31/m
	↔ 2 m		67020111		18	2307	28,31/m
	↔ 3 m		67020112		18	2307	28,31/m

SPLUS profilé Oméga Click

	Acier galvanisé à chaud						
	↔ 1 m		67030110		18	2307	46,14/m
	↔ 2 m		67030111		18	2307	46,14/m
	↔ 3 m		67030112		18	2307	46,14/m

SPLUS protecteur Oméga Click

	Matière synthétique rouge		62031084		19	2307	0,99/pc.
	 50 pc.						

Systemes de suspension – treillis à câbles

	type	référence	stock	page. catal.	groupe d'articles	prix en €	
	SPLUS cheville Oméga						
	Matière synthétique rouge	62031085		19	2307	0,49/pc.	
	 50 pc.						
	SPLUS pendeur Oméga						
	Acier galvanisé Sendzimir	500	62021504	✓	19	2307	18,77/pc.
		600	62021604	✓	19	2307	22,39/pc.
	 5 pc.						
	SPLUS pendeur Oméga						
	Acier galvanisé à chaud	500	62031504		19	2307	25,27/pc.
		600	62031604		19	2307	30,25/pc.
	 5 pc.						
	SPLUS pendeur Oméga						
	Black C8	500	62081504			2307	25,27/pc.
	600	62081604			2307	30,25/pc.	
 5 pc.							
SPLUS pendeur Oméga							
Acier inoxydable AISI 304	500	62051504		19	2307	52,91/pc.	
	600	62051604		19	2307	60,21/pc.	
 5 pc.							
	Etrier de plafond, ouvert						
	Acier galvanisé Sendzimir		67030060		2307	3,57/pc.	
 10 pc.							
	Etrier de plafond, réglable						
	Acier galvanisé à chaud		67030061		2307	8,51/pc.	
	Agrafe pour poutre en I						
	Acier à zingage électrolytique		67020048		2307	36,75/pc.	
	Support panneau sandwich						
	Acier galvanisé Sendzimir	45	67020020		15	2307	5,08/pc.
		90	67020120		15	2307	5,51/pc.
	 10 pc.						
	Support panneau sandwich						
	Acier galvanisé à chaud	45	67030020		15	2307	8,20/pc.
	90	67030120		15	2307	8,78/pc.	
 10 pc.							





Systemes de suspension – treillis à câbles

	type	référence	stock	page. catal.	groupe d'articles	prix en €	
	Boulon à collet carré et écrou 6 pans à embase crénelée						
	Acier à zingage électrolytique	M6x12	67010093	✓	2309	0,35/pc.	
	 100 pc.						
	Boulon à collet carré et écrou 6 pans à embase crénelée						
	Acier galvanisé à chaud	M6x12	67030093	✓	2309	0,49/pc.	
	 100 pc.						
	Boulon à collet carré						
	Acier à zingage électrolytique	M6x12	67010099	✓	24	2309	0,26/pc.
		M6x20	67010100	✓	24	2309	0,29/pc.
	 100 pc.						
	Boulon à collet carré						
	Acier à zingage électrolytique, bichromaté	M6x20	67020100		24	2307	0,38/pc.
	 100 pc.						
	Boulon à collet carré						
	Acier galvanisé à chaud	M6x12	67030099		24	2309	0,33/pc.
		M6x20	67030100	✓	24	2309	0,46/pc.
 100 pc.	M6x30	67030109	✓	24	2309	0,49/pc.	
Boulon à collet carré							
Acier inoxydable AISI 316	M6x20	67060100		24	2309	1,70/pc.	
 100 pc.							
	Écrou 6 pans à embase crénelée						
	Acier à zingage électrolytique	M6	64010059	✓	24	2309	0,20/pc.
	 50 pc.						
	Écrou 6 pans à embase crénelée						
	Acier à zingage électrolytique, bichromaté	M6	64020059		24	2307	0,20/pc.
	 50 pc.						
	Écrou 6 pans à embase crénelée						
	Acier galvanisé à chaud	M6	64030059	✓	24	2309	0,25/pc.
	 50 pc.						
	Écrou 6 pans à embase crénelée						
Acier inoxydable AISI 316	M6	64060059	✓	24	2309	1,00/pc.	
 50 pc.							

Systemes de suspension – treillis à câbles

	type	référence	stock	page. catal.	groupe d'articles	prix en €	
	Boulon						
	Acier à zingage électrolytique  100 pc.	M6x15	67020054		24	2307	0,25/pc.
		M8x15	67010068		24	2307	0,42/pc.
		M8x20	67010065		24	2307	0,49/pc.
		M8x35	67010066		24	2307	0,66/pc.
		M8x65	67020092		24	2307	0,82/pc.
		M10x20	67020059		24	2307	0,82/pc.
		M10x35	67020077		24	2307	1,07/pc.
		M10x60	67020010		24	2307	1,67/pc.
	Boulon						
Acier galvanisé à chaud  100 pc.	M8x15	67030068		24	2307	0,65/pc.	
	M8x20	67030065	✓	24	2307	0,61/pc.	
	M8x35	67030066	✓	24	2307	0,85/pc.	
	M10x20	67030059		24	2307	1,10/pc.	
	M10x35	67030077	✓	24	2307	1,62/pc.	
	M10x60	67030010		24	2307	2,49/pc.	
Boulon							
Acier inoxydable AISI 316  100 pc.	M8x20	67060065		24	2307	1,05/pc.	
	M8x35	67060066		24	2307	1,83/pc.	
	M10x20	67060059		24	2307	2,32/pc.	
	M10x35	67060077		24	2307	2,93/pc.	
	M10x60	67060010		24	2307	4,39/pc.	
	Ecrou hexagonal						
	Acier à zingage électrolytique  100 pc.	M8	67020095		24	2307	0,17/pc.
		M10	67020079		24	2307	0,20/pc.
	Ecrou hexagonal						
	Acier à zingage électrolytique, bichromaté  100 pc.	M8	67020062		24	2307	0,16/pc.
		M10	67020014		24	2307	0,29/pc.
	Ecrou hexagonal						
	Acier galvanisé à chaud  100 pc.	M8	67030062		24	2307	0,23/pc.
		M10	67030014		24	2307	0,77/pc.
	Ecrou hexagonal						
Acier inoxydable AISI 304  100 pc.	M8	67060062		24	2307	1,08/pc.	
	M10	67060014		24	2307	2,47/pc.	
	Rondelle						
	Acier à zingage électrolytique  100 pc.	M8	67020083		24	2307	0,08/pc.
		M10	67020061		24	2307	0,20/pc.
	Rondelle						
	Acier à zingage électrolytique, bichromaté  100 pc.	M8	67020063		24	2307	0,11/pc.
		M10	67020013		24	2307	0,20/pc.
	Rondelle						
	Acier galvanisé à chaud  100 pc.	M8	67030063		24	2307	0,11/pc.
		M10	67030013		24	2307	0,30/pc.
	Rondelle						
Acier inoxydable AISI 316  100 pc.	M8	67060063		24	2307	0,55/pc.	
	M10	67060064		24	2307	0,80/pc.	

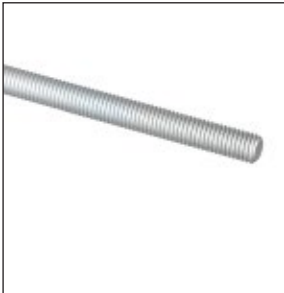
Systemes de suspension – treillis à câbles

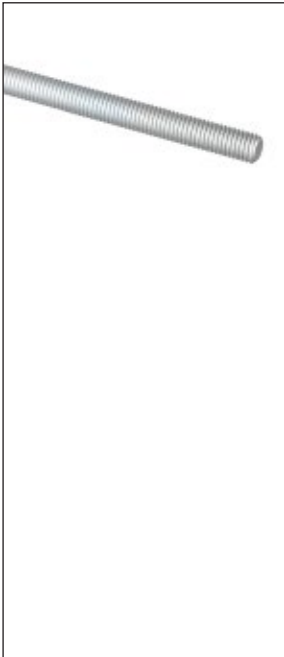
	type	référence	stock	page. catal.	groupe d'articles	prix en €
	Rondelle étoilée					
	Acier inoxydable	M8	67020084		2307	0,26/pc.
	 100 pc.					
	Rondelle étoilée					
	Acier inoxydable	M10	67020086		2307	0,35/pc.
	 100 pc.					
	Tige filetée					
	Acier à zingage électrolytique	M6	67020140		2307	4,74/pc.
	bichromaté	M8	67020044		2307	5,23/pc.
	↔ 0,5 m					
Tige filetée						
Acier inoxydable AISI 316	M8	67060044		2307	28,35/pc.	
↔ 0,5 m						
Tige filetée						
Acier à zingage électrolytique, bichromaté	M6	67020141		14	2307	5,82/m
	M8	67020045	✓	14	2307	6,00/m
	M10	67020145		14	2307	7,42/m
↔ 1 m						
Tige filetée						
Acier inoxydable AISI 316	M6	67060141		14	2307	34,09/m
	M8	67060045		14	2307	37,01/m
	M10	67060145		14	2307	46,44/m
↔ 1 m						

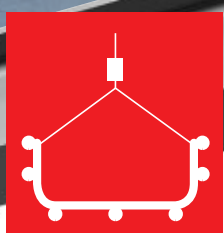

spiderband®

Système de suspension avec câble

Découvrez ici les atouts de **spiderband®**:

- ✓ un montage simple et rapide grâce au système flexible
- ✓ un éventail de possibilités de fixation
- ✓ un montage simple grâce au nombre limité d'articles
- ✓ une grande capacité de charge jusqu'à 120 kg.

rejiband®
CE **pemsa**







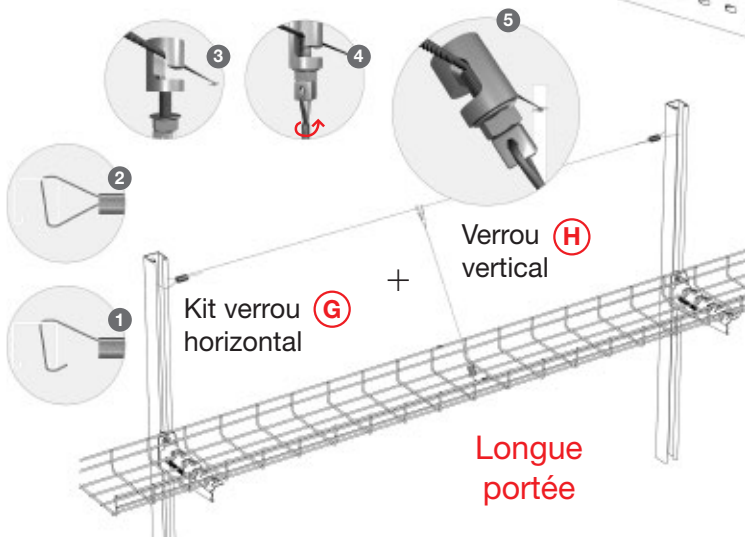
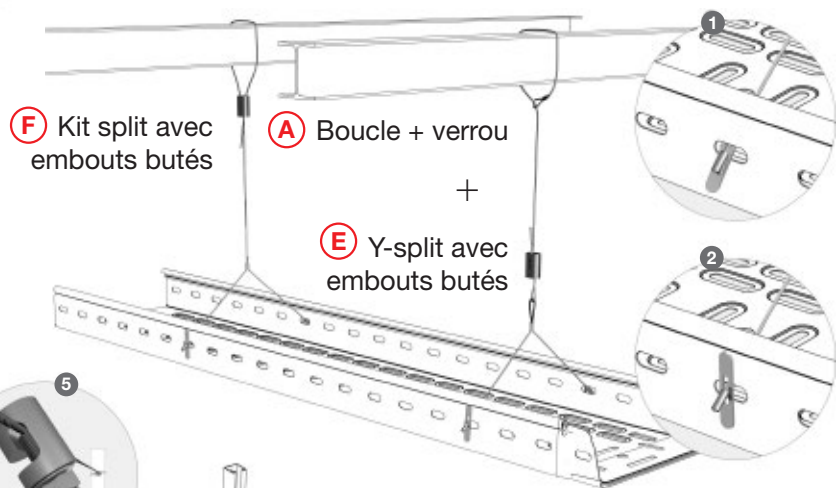
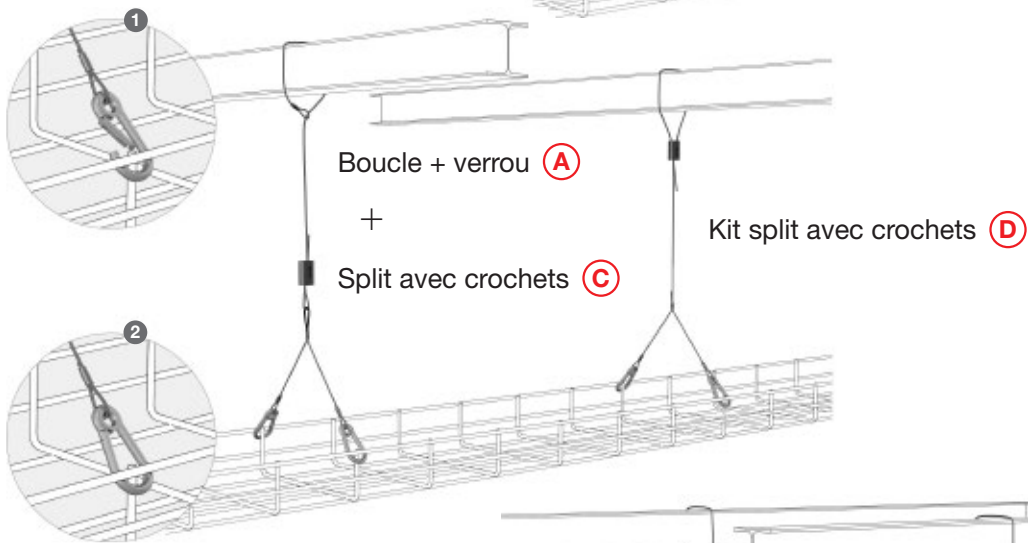
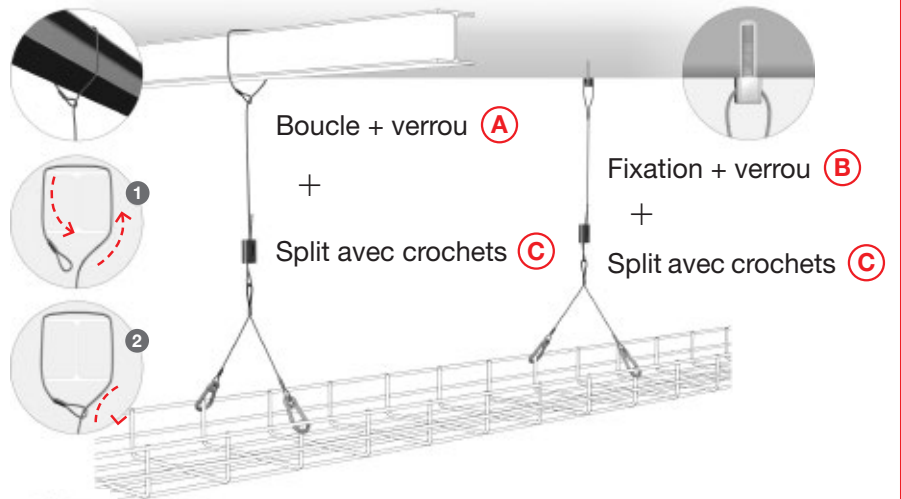

Vue d'ensemble de l'installation



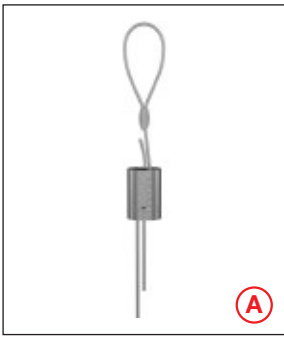

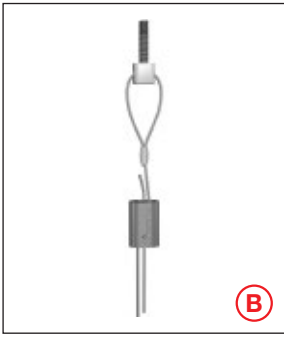





spiderband®



Systeme de suspension avec cable SPIDERBAND

	type	référence	stock	page. catal.	groupe d'articles	prix en €
Verrou						
	Aluminium	10	62301100	✓	1505	6,14/pc.
	 10 pc.	50	62301400	✓	1505	6,96/pc.
		120	62301800		1505	12,65/pc.
Câble						
	Acier à zingage électrolytique					
	↔ 200 m	10	62302102	✓	1505	0,67/m
	↔ 100 m	50	62302401	✓	1505	0,75/m
120		62302801		1505	1,12/m	
Boucle + verrou						
	Acier à zingage électrolytique					
	 10 pc.	10/1	62303101	✓	1505	9,80/pc.
		45/1	62303301	✓	1505	11,90/pc.
		90/1	62303601		1505	27,92/pc.
		10/3	62303103		1505	12,50/pc.
		45/3	62303303		1505	15,05/pc.
		90/3	62303603		1505	31,43/pc.
		10/5	62303105		1505	15,19/pc.
45/5	62303305	✓	1505	18,11/pc.		
90/5	62303605		1505	34,95/pc.		
Fixation + verrou						
	Acier à zingage électrolytique					
	10/M6x20/1	62304101	✓	1505	10,03/pc.	
	45/M8x20/1	62304301	✓	1505	12,20/pc.	
	90/M8x20/1	62304601		1505	13,77/pc.	
	10/M6x20/3	62304103		1505	12,72/pc.	
	45/M8x20/3	62304303		1505	15,35/pc.	
	90/M8x20/3	62304603		1505	17,36/pc.	
	10/M6x20/5	62304105		1505	21,18/pc.	
	45/M8x20/5	62304305		1505	18,48/pc.	
90/M8x20/5	62304605		1505	30,08/pc.		
Split avec crochets						
	Acier à zingage électrolytique	50/300	62305430	✓	1505	9,43/pc.
	 10 pc.	50/460	62305440		1505	9,73/pc.
Split avec crochets + verrou						
	Acier à zingage électrolytique	35/300/1	62307231	✓	1505	20,51/pc.
	 10 pc.	90/300/1	62307631	✓	1505	27,32/pc.
		35/300/3	62307233		1505	22,23/pc.
		90/300/3	62307633		1505	31,96/pc.
		35/460/1	62307241	✓	1505	20,58/pc.
		90/460/1	62307641		1505	27,32/pc.
		35/460/3	62307243		1505	22,30/pc.
		90/460/3	62307643		1505	30,76/pc.

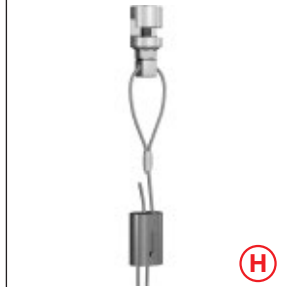
Systeme de suspension avec cable SPIDERBAND

	type	référence	stock	page. catal.	groupe d'articles	prix en €
	Y-split avec embouts butés					
	Acier à zingage électrolytique	35/300	62306230	✓	1505	8,53/pc.
	 10 pc.	35/460	62306240		1505	8,83/pc.
		35/500	62306250		1505	9,05/pc.
	Y-split avec embouts butés + verrou					
	Acier à zingage électrolytique	35/300/1	62308231	✓	1505	18,56/pc.
	 10 pc.	90/300/1	62308631	✓	1505	26,49/pc.
		35/300/3	62308233		1505	20,06/pc.
		90/300/3	62308633		1505	29,04/pc.
		35/460/1	62308241	✓	1505	18,48/pc.
		90/460/1	62308641		1505	26,72/pc.
		35/460/3	62308243		1505	20,21/pc.
90/460/3		62308643		1505	29,27/pc.	
	Verrou + câble horizontal + verrou					
	Acier à zingage électrolytique					
	 5 pc.	75/5	62309501		1505	98,79/pc.
		75/10	62309502		1505	114,43/pc.
 2 pc.	75/15	62309503		1505	130,15/pc.	
	Crochet + câble vertical					
	Acier à zingage électrolytique	35/1	62310201		1505	20,06/pc.
	 10 pc.					



Les profilés Stagobel

La gamme de profilés Stagobel est disponible dans **diverses longueurs, largeurs et finitions** : un profilé simple ou double, avec ou sans rebord dentelé, différents types de perforation, etc., et ce, en Sendzimir, en galvanisé à chaud ou en acier inoxydable.

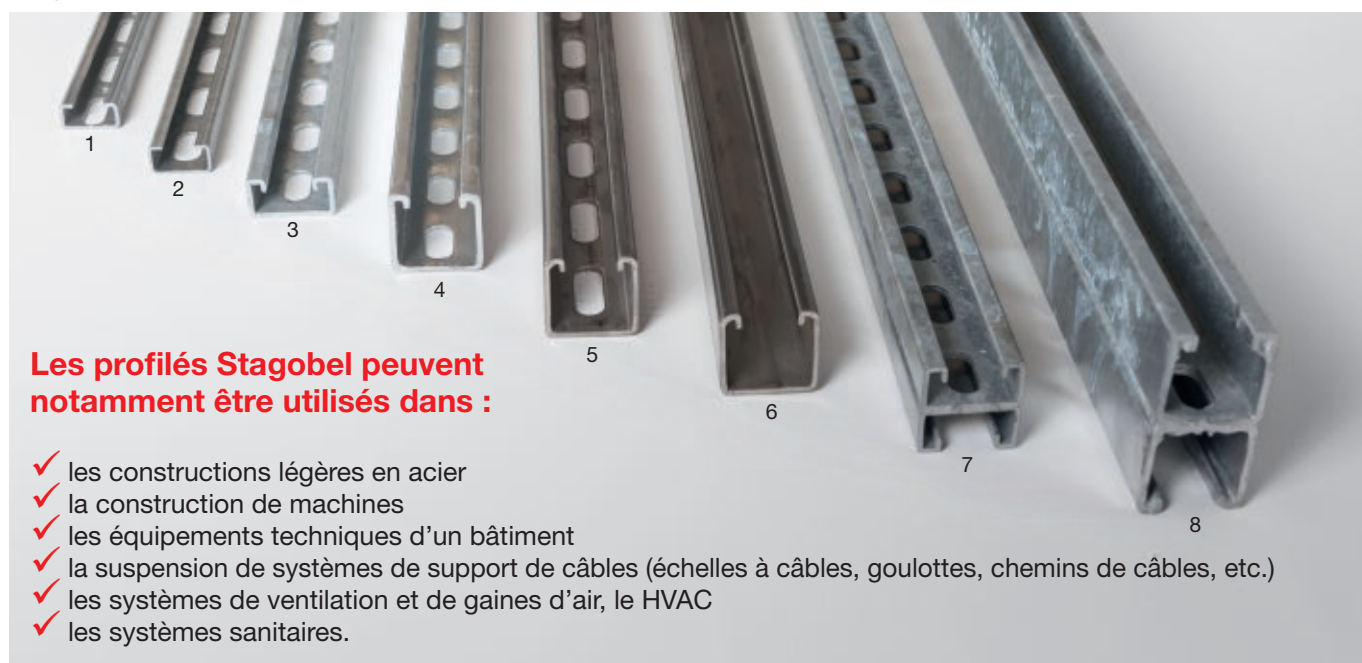

Les profilés Stagobel peuvent notamment être utilisés dans :







- ✓ les constructions légères en acier
- ✓ la construction de machines
- ✓ les équipements techniques d'un bâtiment
- ✓ la suspension de systèmes de support de câbles (échelles à câbles, goulottes, chemins de câbles, etc.)
- ✓ les systèmes de ventilation et de gaines d'air, le HVAC
- ✓ les systèmes sanitaires.









	1	2	3	4	5	6	7	8
Dimensions (mm)	30x15	30x15	41x21	41x41	41x41	41x41	41x21 (double)	41x41 (double)
Epaisseur (mm)	2,0	1,5	2,0 2,5	2,0 2,5	2,5	2,5	2,0	2,5
Longueur (mm)	2000	4000	6000 3000 6000	6000 3000 6000	6000	6000	6000	6000
Modèle de perforation (mm)	30x11 + 5x5	30x14	30x14	30x14	40x13	/	30x14	30x14
Rebord dentelé			✓	✓			✓	✓
G.S.	✓	✓						
H.D.			✓	✓			✓	✓
INOX 316					✓	✓		

G.S. galvanisation Sendzimir NBN EN 10346 – recommandé dans les environnements corrosifs C2 (faible)
H.D. galvanisation à chaud NBN EN ISO 1461 – recommandé dans les environnements corrosifs C3/C4 (moyen/haut)
INOX 316 acier inoxydable AISI 316 – recommandé dans les environnements corrosifs C5-M (très élevé/maritime)

 voir page 2

Profilés







	type	référence	📦 stock	page. catal.	groupe d'articles	prix en €
	Profilé 30-15-2.0 avec perforations 30x11 + 5x5					
	Acier galvanisé Sendzimir					
↔ 2 m	2000	PROF30-15-2.0-2/GS	✓		1501	6,58/m
	Profilé 30-15-1.5 avec perforations 30x14					
	Acier galvanisé Sendzimir					
↔ 4 m	4000	PROF30-15-1.5-4/GS	✓		1501	5,25/m
	Profilé 41-21-2.0 avec perforations 30x14					
	Acier galvanisé à chaud					
↔ 6 m	6000	PROF41-21-2.0-6/HD	✓		1501	14,38/m
	Profilé 41-21-2.5 avec perforations 30x14					
	Acier galvanisé à chaud					
	↔ 3 m	3000	PROF41-21-2.5-3/HD	✓	1501	18,02/m
	↔ 6 m	6000	PROF41-21-2.5-6/HD	✓	1501	18,02/m
	Profilé 41-41-2.0 avec perforations 30x14					
	Acier galvanisé à chaud					
↔ 6 m	6000	PROF41-41-2.0-6/HD	✓		1501	21,52/m
	Profilé 41-41-2.5 avec perforations 30x14					
	Acier galvanisé à chaud					
	↔ 3 m	3000	PROF41-41-2.5-3/HD	✓	1501	24,46/m
	↔ 6 m	6000	PROF41-41-2.5-6/HD	✓	1501	24,46/m

	type	référence	stock	page. catal.	groupe d'articles	prix en €
	Profilé 41-41-2.5 avec perforations 40x13					
	Acier inoxydable AISI 316					
	↔ 6 m	6000	PROF41-41-2.5-6/RVS316P ✓		1501	108,18/m
	Profilé 41-41-2.5 sans perforations					
	Acier inoxydable AISI 316					
	↔ 6 m	6000	PROF41-41-2.5-6/RVS316 ✓		1501	103,52/m
	Profilé double 41-21-2.0, hauteur = 42 mm, avec perforations 30x14					
	Acier galvanisé à chaud					
	↔ 6 m	6000	PROFD41-21-2.0-6/HD ✓		1501	32,12/m
	Profilé double 41-41-2.5, hauteur = 82 mm, avec perforations 30x14					
	Acier galvanisé à chaud					
	↔ 6 m	6000	PROFD41-41-2.5-6/HD ✓		1501	54,76/m
	Bouchon pour profilé épaisseur 2,5 mm et hauteur 21 mm					
	Matière synthétique, vert foncé					
	 50 pc.	21	KOKSPLDB ✓		1503	1,89/pc.
	Bouchon pour profilé épaisseur 2,5 mm et hauteur 41 mm					
	Matière synthétique, vert foncé					
	 50 pc.	41	KOKSPSDB ✓		1503	2,94/pc.

Profilés











	type	référence	stock	page. catal.	groupe d'articles	prix en €
	Raccord droit 40x6x184					
	Acier galvanisé à chaud	N1 67030205	✓		1503	5,45/pc.
	Raccord droit renforcé 49x56x181					
	Acier galvanisé à chaud	N2 67030214	✓		1503	17,75/pc.
	Equerre 90° 50x50x40					
	Acier galvanisé à chaud	N3 67030201	✓		1503	2,49/pc.
	Equerre 90° 95x95x40					
	Acier galvanisé à chaud	N4 67030202	✓		1503	4,98/pc.
	Equerre 135° 75x105x39					
	Acier galvanisé à chaud	N5 67030210	✓		1503	4,27/pc.
	Equerre 45° 66x63x39					
	Acier galvanisé à chaud	N6 67030209	✓		1503	4,27/pc.
	Raccord en L 88x6x88					
	Acier galvanisé à chaud	N7 67030211	✓		1503	5,76/pc.

Profilés

	type	référence	📦 stock	page. catal.	groupe d'articles	prix en €
	Raccord en T 90° 105x51x90					
	Acier galvanisé à chaud	N8 67030204	✓		1503	10,90/pc.
	Raccord en T 90x6x140					
	Acier galvanisé à chaud	N9 67030203	✓		1503	14,24/pc.
	Raccord trois directions 114x6x114					
	Acier galvanisé à chaud	N10 67030212	✓		1503	6,92/pc.
	Equerre 90° renforcée 101x101x48					
	Acier galvanisé à chaud	N11 67030213	✓		1503	15,34/pc.
	Etrier Oméga (40x47x142)					
	Acier galvanisé à chaud	N12 67030207	✓		1503	15,34/pc.
	Etrier Oméga (40x87x141)					
	Acier galvanisé à chaud	N13 67030208	✓		1503	6,62/pc.
	Etrier Oméga (40x27x142)					
	Acier galvanisé à chaud	N14 67030206	✓		1503	7,32/pc.

Profilés

	type	référence	📦 stock	page. catal.	groupe d'articles	prix en €
	Equerre 90° double 50x90x90					
	Acier galvanisé à chaud	N15 67030215	✓		1503	6,00/pc.
	Equerre 90° triple 50x90x90					
	Acier galvanisé à chaud	N16 67030216	✓		1503	12,69/pc.
	Support profilé 41x41 (106x150x150)					
	Acier galvanisé à chaud	67030064	✓		1503	32,54/pc.
	Support profilé 41x82 (94x150x150)					
	Acier galvanisé à chaud	67030164	✓		1503	30,04/pc.
	Articulation réglable 154x135x77					
	Acier galvanisé à chaud	67030102	✓		1503	27,86/pc.
	Etrier pour profilé / poutre en I (95x70x80)					
	Acier galvanisé à chaud	67030101	✓		1503	14,72/pc.
	Accouplement treillis / profilé					
	Acier galvanisé à chaud	67030049	✓		2307	2,55/pc.
	 50 pc.					

	type	référence	stock	page. catal.	groupe d'articles	prix en €
	Ecrou coulissant					
	Acier à zingage électrolytique	M6	67020055	✓	1503	1,00/pc.
	 100 pc.	M8	67010056	✓	1503	1,00/pc.
		M10	67011058	✓	1503	1,44/pc.
		Ecrou coulissant				
	Acier galvanisé à chaud	M6	67030054	✓	1503	1,34/pc.
	 100 pc.	M8	67030056	✓	1503	1,34/pc.
		M10	67031058	✓	1503	1,67/pc.
		Ecrou coulissant				
Acier inoxydable AISI 316	M6	67060054	✓	1503	8,13/pc.	
 100 pc.	M8	67060056	✓	1503	8,44/pc.	
	M10	67060058	✓	1503	9,63/pc.	
	Ecrou coulissant avec ressort					
Acier à zingage électrolytique	M10 / 21	67020058	✓	1503	1,78/pc.	
 100 pc.	M10 / 41	67020158	✓	1503	2,00/pc.	
	Ecrou coulissant avec ressort					
Acier galvanisé à chaud	M6 / 21	67630058	✓	1503	1,56/pc.	
 100 pc.	M6 / 41	67630158	✓	1503	1,67/pc.	
	M8 / 21	67830058	✓	1503	1,78/pc.	
	M8 / 41	67830158	✓	1503	1,84/pc.	
	M10 / 21	67030058	✓	1503	1,95/pc.	
	M10 / 41	67030158	✓	1503	2,05/pc.	
	Boulon coulissant à ressort					
Acier à zingage électrolytique	M10x30	67020159		1503	3,07/pc.	
 100 pc.						
	Boulon hexagonal					
	Acier à zingage électrolytique	M8X35	67010066		2307	0,66/pc.
	 100 pc.	M10X35	67020077		2307	1,07/pc.
		Boulon hexagonal				
	Acier galvanisé à chaud	M8X35	67030066	✓	2307	0,85/pc.
	 100 pc.	M10X35	67030077	✓	2307	1,62/pc.
Boulon hexagonal						
Acier inoxydable AISI 316L	M8X35	67060066		2307	1,83/pc.	
 100 pc.	M10X35	67060077		2307	2,93/pc.	





Systemes de support de câbles avec maintien de fonction

Objectif

Les systemes de support de câbles avec maintien de fonction sont essentiels pour une infrastructure à l'épreuve du feu. Les systemes de sécurité tels qu'un éclairage de secours, un systeme d'alarme incendie, ... doivent, en cas d'incendie, continuer à fonctionner parfaitement pendant une durée déterminée. Il est dès lors crucial qu'outre le câblage, les systemes de support de câbles (échelle à câbles, chemin de câbles et treillis à câbles) aient aussi ces propriétés ignifuges et garantissent donc, en cas d'incendie, la fonctionnalité et la fiabilité de l'installation durant cette période.

Application

Les systemes de support de câbles avec maintien de fonction sont notamment appliqués pour des installations d'évacuation des fumées, de ventilation, d'alarme et de sécurité dans les bâtiments publics, les immeubles de bureaux, les tunnels, les hôpitaux, ...



Echelles à câbles KHZPS – p. 128-129



Treillis à câbles Rejistand – p. 130-132
Chemins de câbles Pemsaband – p. 133-135



Boîte de connexion E90 – p. 138-139

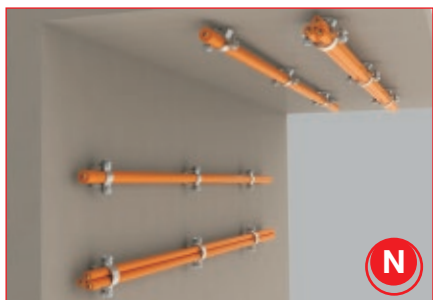

Attache OMEGA E90 – p. 137



Etrier de câbles E90 – p. 136





Attache câbles E90 – p. 136

Maintien de fonction – échelles à câbles

	type	référence	📦 stock	page. catal.	groupe d'articles	prix en €	
	Echelle à câbles KHZPS						
	Acier galvanisé Sendzimir	150	725350	✓	23	1308	40,75/m
	↔ 6 m	200	725351	✓	23	1308	40,75/m
		300	725352	✓	23	1308	42,14/m
		400	725353	✓	23	1308	43,90/m
	Accouplement 21						
	Zinc+	21	795051	✓	78	1313	14,02/pc.
	📦 10 pc.						
	Console 50						
	Acier galvanisé à chaud	50/ 150	723433	✓	32	1304	14,18/pc.
		50/ 200	723434	✓	32	1304	14,54/pc.
		50/ 300	723436	✓	32	1304	16,74/pc.
		50/ 400	723437	✓	32	1304	26,46/pc.
	Etrier 42						
	Acier galvanisé Sendzimir	42	795239		34	1313	5,34/pc.
	📦 10 pc.						
	Pendard simple 2F						
	Acier galvanisé à chaud	2F/ 280	717196	✓	46	1313	22,18/pc.
		2F/ 370	717197	✓	46	1313	25,34/pc.
		2F/ 505	717198	✓	46	1313	28,77/pc.
		2F/ 640	794202			1313	29,79/pc.
		2F/ 730	717199	✓	46	1313	33,02/pc.
	Fixation tige/console 82						
	Acier galvanisé à chaud	82	786768		36	1313	66,93/pc.
	📦 10 pc.						

Maintien de fonction – échelles à câbles





	type	référence	 stock	page. catal.	groupe d'articles	prix en €
	Tige filetée M10					
	Acier à zingage électrolytique	2000	716792	✓	42	1313
	↔ 2 m					
	Erou hexagonal					
	Acier galvanisé à chaud	M10	723938		42	1313
	 100 pc.					
	Boulon hexagonal M8 x 50					
	Acier à zingage électrolytique	M8x50	795132			1313
	 100 pc.					
	Erou hexagonal					
	Acier à zingage électrolytique	M8	794715	✓		1313
	 100 pc.					

Maintien de fonction – treillis à câbles



Treillis à câbles Rejiband 60

Acier à zingage électrolytique, bichromaté

type	référence	stock	page. catal.	groupe d'articles	prix en €		
↔ 3 m	 24 m	60 x 100	60222100	✓	4	2301	12,38/m
		60 x 150	60222150	✓	4	2301	15,30/m
	 18 m	60 x 200	60222200	✓	4	2301	17,36/m
	 12 m	60 x 300	60222300	✓	4	2301	22,50/m
	 6 m	60 x 400	60222400	✓	4	2301	32,33/m

Treillis à câbles Rejiband 60

Acier galvanisé à chaud

↔ 3 m	 24 m	60 x 100	60232100	✓	4	2305	17,30/m
		60 x 150	60232150	✓	4	2305	21,41/m
	 18 m	60 x 200	60232200	✓	4	2305	25,35/m
	 12 m	60 x 300	60232300	✓	4	2305	34,67/m
	 6 m	60 x 400	60232400	✓	4	2305	45,79/m



Accouplement renforcé 61

Acier à zingage électrolytique, bichromaté

64020061

✓

4

2307

1,55/pc.

 50 pc.

Accouplement renforcé 61

Acier galvanisé à chaud

64030061

✓

4

2307

2,19/pc.

 50 pc.



Accouplement 60

Acier à zingage électrolytique, bichromaté

64020060

✓

4

2307

1,14/pc.

 50 pc.

Accouplement 60

Acier galvanisé à chaud

64030060

✓

4

2307

1,72/pc.

 50 pc.











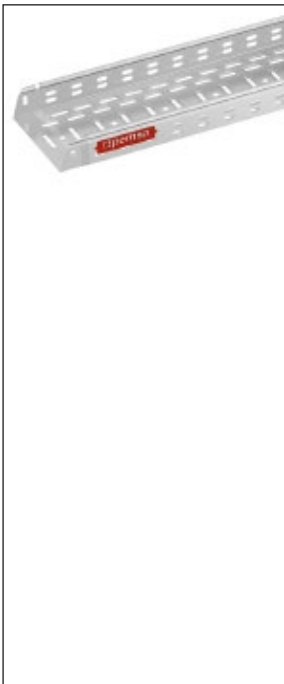



Maintien de fonction – treillis à câbles

	type	référence	stock	page. catal.	groupe d'articles	prix en €
	SPLUS console Oméga Click					
	Acier galvanisé Sendzimir	100	62021104	✓	4	2307 6,29/pc.
	 5 pc.	150	62021154	✓	4	2307 8,13/pc.
		200	62021204	✓	4	2307 9,31/pc.
		300	62021304	✓	4	2307 10,98/pc.
		400	62021404	✓	4	2307 16,42/pc.
SPLUS console Oméga Click						
Acier galvanisé à chaud	100	62031104	✓	4	2307 9,63/pc.	
 5 pc.	150	62031154	✓	4	2307 12,32/pc.	
	200	62031204	✓	4	2307 13,20/pc.	
	300	62031304	✓	4	2307 14,12/pc.	
	400	62031404	✓	4	2307 21,79/pc.	
	SPLUS étrier en C Oméga Click					
Acier galvanisé Sendzimir	100	62022104	✓	8	2307 12,42/pc.	
 4 pc.	150	62022154	✓	8	2307 13,05/pc.	
	200	62022204	✓	8	2307 14,03/pc.	
	300	62022304	✓	8	2307 16,42/pc.	
	400	62022404	✓	8	2307 24,23/pc.	
	SPLUS étrier en C Oméga Click					
Acier galvanisé à chaud	100	62032104	✓	8	2307 16,42/pc.	
 4 pc.	150	62032154	✓	8	2307 18,06/pc.	
	200	62032204	✓	8	2307 20,16/pc.	
	300	62032304	✓	8	2307 24,16/pc.	
	400	62032404	✓	8	2307 36,94/pc.	
	SPLUS connecteur Oméga E90					
Acier galvanisé à chaud		62031090	✓	4	2307 6,22/pc.	
 60 pc.						
E90 accouplement 60						
Acier galvanisé à chaud	M6x30	64030160	✓	4	2307 2,10/pc.	
 50 pc.						
Tige filetée						
	Acier à zingage électrolytique, bichromaté	M8/0,5m	67020044		4	2307 5,23/pc.
		M8/1m	67020045	✓	4	2307 6,00/m
	↔ 0,5 m ↔ 1 m	M10/1m	67020145		4	2307 7,42/m
Ecrou hexagonal						
	Acier à zingage électrolytique, bichromaté	M8	67020062		4	2307 0,16/pc.
		M10	67020014		4	2307 0,29/pc.
 100 pc.						









Maintien de fonction – treillis à câbles

	type	référence	stock	page. catal.	groupe d'articles	prix en €		
	Pendant simple							
	Acier galvanisé à chaud	500 1000	67030660 67030661		10 2307	42,69/pc. 64,42/pc.		
	Pendant double							
	Acier galvanisé à chaud	500 1000	67030662 67030663		10 2307	82,10/pc. 143,92/pc.		
	Boulon hexagonal							
	Acier à zingage électrolytique Acier galvanisé à chaud	M10x35 M10x35	67020077 67030077	✓	10 2307	1,07/pc. 1,62/pc.		
	📦 100 pc.							
	Ecrou coulissant avec ressort							
	Acier à zingage électrolytique Acier galvanisé à chaud	M10/41 M10/41	67020158 67030158	✓ ✓	10 1503	2,00/pc. 2,05/pc.		
	📦 100 pc.							
	RPLUS console Click							
	Acier galvanisé Sendzimir	100 150 200 300 400	62025103 62025153 62025203 62025303 62025403	✓ ✓ ✓ ✓ ✓	6 6 6 6 6	2307 2307 2307 2307 2307	7,86/pc. 9,17/pc. 10,55/pc. 12,08/pc. 17,44/pc.	
		📦 4 pc.						
		RPLUS console Click						
		Acier galvanisé à chaud	100 150 200 300 400	62035103 62035153 62035203 62035303 62035403	✓ ✓ ✓ ✓ ✓	6 6 6 6 6	2307 2307 2307 2307 2307	12,14/pc. 13,57/pc. 16,03/pc. 19,85/pc. 22,20/pc.
			📦 4 pc.					
		RPLUS connecteur E90						
		Acier galvanisé à chaud		62035001		6 2307	6,22/pc.	
		📦 15 pc.						







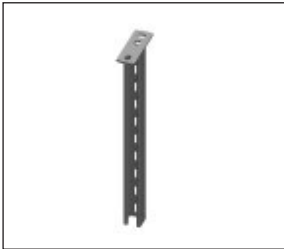

Maintien de fonction – chemins de câbles

	type	référence	stock	page. catal.	groupe d'articles	prix en €	
	Chemin de câbles Pemsaband SX Click, H = 60 mm						
	Acier galvanisé Sendzimir						
	↔ 3 m	 24 m	60x100 75522100	✓	12	2308	10,16/m
		 12 m	60x150 75522150	✓	12	2308	13,57/m
			60x200 75522200	✓	12	2308	14,71/m
		 6 m	60x300 75522300	✓	12	2308	19,58/m
			60x400 75522400	✓	12	2308	28,29/m
	Chemin de câbles Pemsaband SX Click, H = 60 mm						
	Acier galvanisé à chaud						
	↔ 3 m	 24 m	60x100 75232100	✓	12	2308	26,53/m
	 12 m	60x150 75232150		12	2308	31,32/m	
		60x200 75232200	✓	12	2308	37,65/m	
	 6 m	60x300 75232300	✓	12	2308	47,93/m	
		60x400 75232400	✓	12	2308	61,91/m	
	Boulon à collet carré et écrou 6 pans à embase crénelée						
	Acier à zingage électrolytique M6x12 67010093 ✓ 2309 0,35/pc.						
	 100 pc.						
	Boulon à collet carré et écrou 6 pans à embase crénelée						
	Acier galvanisé à chaud M6x12 67030093 ✓ 2309 0,49/pc.						
	 100 pc.						
	Tige filetée						
	Acier à zingage électrolytique, M8/0,5m 67020044 12 2307 5,23/pc.						
	bichromaté M8/1m 67020045 ✓ 12 2307 6,00/m						
	↔ 0,5 m ↔ 1 m M10/1m 67020145 12 2307 7,42/m						
	Écrou hexagonal						
	Acier à zingage électrolytique, M8 12 2307 0,16/pc.						
	bichromaté M10 67020014 12 2307 0,29/pc.						
 100 pc.							













Maintien de fonction – chemins de câbles







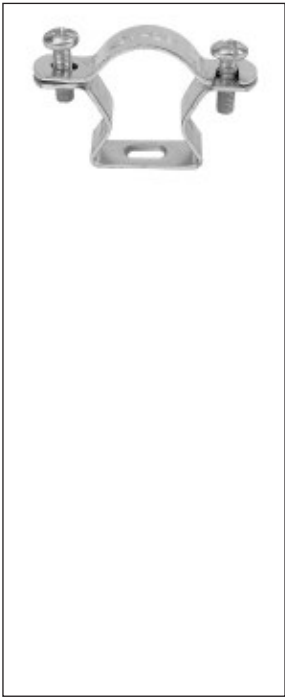

	type	référence	stock	page. catal.	groupe d'articles	prix en €	
	SPLUS console Oméga Click						
	Acier galvanisé Sendzimir	100	62021104	✓	12	2307	6,29/pc.
	 5 pc.	150	62021154	✓	12	2307	8,13/pc.
		200	62021204	✓	12	2307	9,31/pc.
		300	62021304	✓	12	2307	10,98/pc.
400		62021404	✓	12	2307	16,42/pc.	
	SPLUS console Oméga Click						
	Acier galvanisé à chaud	100	62031104	✓	12	2307	9,63/pc.
	 5 pc.	150	62031154	✓	12	2307	12,32/pc.
		200	62031204	✓	12	2307	13,20/pc.
		300	62031304	✓	12	2307	14,12/pc.
400		62031404	✓	12	2307	21,79/pc.	
	SPLUS connecteur Oméga E90						
	Acier galvanisé à chaud		62031090	✓	12	2307	6,22/pc.
 60 pc.							
	Boulon à collet carré						
	Acier galvanisé à chaud	M6x30	67030109	✓	12	2309	0,49/pc.
 100 pc.							
	Ecrou 6 pans à embase crénelée						
	Acier galvanisé à chaud	M6	64030059	✓	12	2309	0,25/pc.
 50 pc.							
	SPLUS profilé support Click						
	Acier galvanisé Sendzimir	100	63022104	✓	16	2307	4,26/pc.
	 10 pc.	150	63022154	✓	16	2307	4,70/pc.
		200	63022204	✓	16	2307	5,90/pc.
		300	63022304	✓	16	2307	6,94/pc.
400		63022404	✓	16	2307	9,38/pc.	
	SPLUS profilé support Click						
	Acier galvanisé à chaud	100	63032104		16	2307	7,08/pc.
	 10 pc.	150	63032154		16	2307	7,57/pc.
		200	63032204		16	2307	9,26/pc.
		300	63032304		16	2307	11,11/pc.
400		63032404		16	2307	13,49/pc.	

Maintien de fonction – chemins de câbles

	type	référence	 stock	page. catal.	groupe d'articles	prix en €	
	Pendant simple						
	Acier galvanisé à chaud	500	67030660		18	2307	42,69/pc.
		1000	67030661		18	2307	64,42/pc.
	Pendant double						
	Acier galvanisé à chaud	500	67030662		18	2307	82,10/pc.
		1000	67030663		18	2307	143,92/pc.
	RPLUS console Click						
	Acier galvanisé Sendzimir	100	62025103	✓	18	2307	7,86/pc.
	 4 pc.	150	62025153	✓	18	2307	9,17/pc.
		200	62025203	✓	18	2307	10,55/pc.
		300	62025303	✓	18	2307	12,08/pc.
400		62025403	✓	18	2307	17,44/pc.	
	RPLUS console Click						
	Acier galvanisé à chaud	100	62035103	✓	18	2307	12,14/pc.
	 4 pc.	150	62035153	✓	18	2307	13,57/pc.
		200	62035203	✓	18	2307	16,03/pc.
		300	62035303	✓	18	2307	19,85/pc.
400		62035403	✓	18	2307	22,20/pc.	
	RPLUS connecteur E90						
	Acier galvanisé à chaud		62035001		18	2307	6,22/pc.
	 15 pc.						

Maintien de fonction





	type	référence	stock	page. catal.	groupe d'articles	prix en €	
	Attache pour câble simple						
	Acier galvanisé Sendzimir		diam. câble				
	 1000 pc. = 1 bt.	simple	4 mm	K6706PO	✓	2508	252,20/bt.
		simple	6 mm	K6708PO	✓	2508	285,08/bt.
		simple	8 mm	K6710PO	✓	2508	288,96/bt.
simple		10 mm	K6712PO	✓	2508	291,06/bt.	
	Attache pour câble simple						
	Acier galvanisé à chaud		diam. câble				
	 1000 pc. = 1 bt.	simple	6 mm	K6708POGMT		2508	396,00/bt.
		simple	8 mm	K6710POGMT		2508	468,80/bt.
simple		10 mm	K6712POGMT		2508	540,40/bt.	
	Attache pour câble simple						
	Acier galvanisé Sendzimir		diam. câble				
 500 pc. = 1 bt.	simple	14 mm	K6716EP0		2508	216,19/bt.	
	Attache pour câble simple						
Acier galvanisé à chaud		diam. câble					
 500 pc. = 1 bt.	simple	14 mm	K6716EPOGMT		2508	324,82/bt.	
	Attache pour câble simple						
	Acier galvanisé Sendzimir		diam. câble				
 400 pc. = 1 bt.	double	14 mm	K6716EDPO		2508	316,80/bt.	
Attache pour câble simple							
Acier galvanisé à chaud		diam. câble					
 400 pc. = 1 bt.	double	14 mm	K6716EDPOGMT		2508	345,60/bt.	
	Etrier pour groupe de câbles						
	Acier galvanisé Sendzimir		KSD2S				
 5 pc.				✓	2508	2,03/pc.	

	type	référence	stock	page. catal.	groupe d'articles	prix en €	
	Attache Oméga pour plusieurs câbles						
	Acier galvanisé Sendzimir	diam. câble					
	 100 pc. = 1 bt.	12-14 mm	K5216EZNMS		2508		407,49/bt.
		14-18 mm	K5220ZNMS		2508		349,34/bt.
		18-22 mm	K5225ZNMS		2508		373,26/bt.
	 50 pc. = 1 bt.	22-30 mm	K5232ZNMS		2508		238,05/bt.
	 25 pc. = 1 bt.	38-50 mm	K5250ZNMS		2508		121,69/bt.
		51-60 mm	K5263ZNMS		2508		187,74/bt.
	Attache Oméga pour plusieurs câbles						
	Acier galvanisé à chaud	diam. câble					
 50 pc. = 1 bt.	12-14 mm	K5216EZNMF		2508		189,14/bt.	
	14-18 mm	K5220ZNF		2508		201,00/bt.	
	18-22 mm	K5225ZNF		2508		214,20/bt.	
 25 pc. = 1 bt.	22-30 mm	K5232ZNF		2508		125,10/bt.	
 20 pc. = 1 bt.	30-38 mm	K5240ZNF		2508		122,40/bt.	
	38-50 mm	K5250ZNF		2508		145,44/bt.	
	51-60 mm	K5263ZNF		2508		172,08/bt.	
Vis à béton 6,3X35							
Acier galvanisé à chaud	6,3x35	KSB6.3X35POGMT	✓	2508		66,87/sac	
 100 pc. = 1 sac							

Maintien de fonction

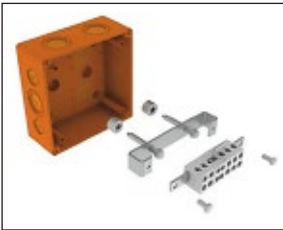
	type	référence	🌀 stock	page. catal.	groupe d'articles	prix en €
	E90 Boîte de connexion IP66 pour câbles d'alimentation, avec bornier simple					
Matière synthétique exempte d'halogènes	1,5-6 mm ²	KKSK100P0	✓	2508		70,81/pc.
	E90 Boîte de connexion IP66 pour câbles d'alimentation, avec bornier simple					
Matière synthétique exempte d'halogènes	1,5-10 mm ²	KKSK125P010		2508		89,16/pc.
	E90 Boîte de connexion IP66 pour câbles d'alimentation, avec bornier simple					
Matière synthétique exempte d'halogènes	1,5-16 mm ²	KKSK175P016		2508		122,92/pc.
	E90 Boîte de connexion IP66 pour câbles d'alimentation, avec bornier double					
Matière synthétique exempte d'halogènes	1,5-6 mm ²	KKSK1252P06	✓	2508		95,88/pc.
	E90 Boîte de connexion IP66 pour câbles d'alimentation, avec bornier double					
Matière synthétique exempte d'halogènes	1,5-10 mm ²	KKSK1752P010	✓	2508		122,92/pc.

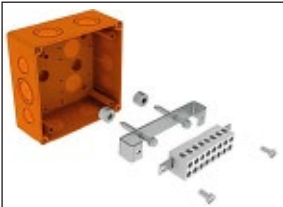
Maintien de fonction

	type	référence	 stock	page. catal.	groupe d'articles	prix en €
	E90 Boîte de connexion IP66 pour câbles d'alimentation, avec bornier simple et fusible					
Matière synthétique exempte d'halogènes	1,5-6 mm ²	KKSK125P06P		2508		103,32/pc.
	E90 Boîte de connexion IP66 pour câbles d'alimentation, avec bornier simple et fusible					
Matière synthétique exempte d'halogènes	1,5-10 mm ²	KKSK175P010P		2508		134,50/pc.
	E90 Boîte de connexion IP66 pour câbles de données, avec bornier					
Matière synthétique exempte d'halogènes	0,5-4 mm ²	KKSK125DPO		2508		104,80/pc.
	E90 Boîte de connexion IP66 pour câbles de données, avec bornier					
Matière synthétique exempte d'halogènes	0,5-4 mm ²	KKSK175DPO		2508		137,68/pc.



Canal de sol ouvert pour charges lourdes



Gaine de sol noyée –
boîte de sol en polyamide



Gaine de sol noyée –
boîte de sol en acier inoxydable



Gaine de sol noyée –
boîte de sol en acier inoxydable



Boîte de sol BODO
en aluminium



Boîte de sol BODO en matière synthétique



Boîte de sol en acier inoxydable



Systemes de gaines de sol

Systemes de canal de sol au ras du sol

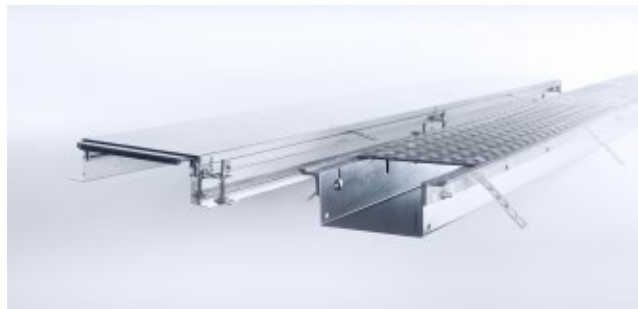

Canal de sol ouvert pour bureaux page 144-145

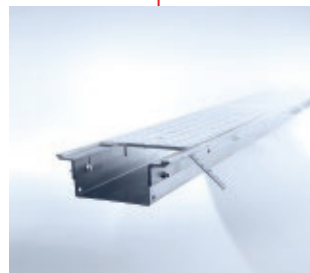

Canal de sol ouvert pour charges lourdes page 145-146

Systemes de gaines de sol noyees

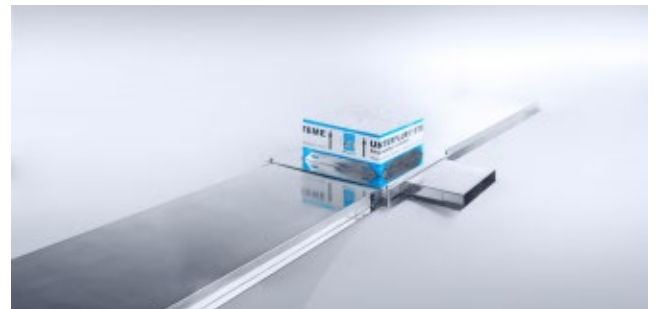

Gaine de sol noyee fermee Voir tableau de selection aux pages suivantes

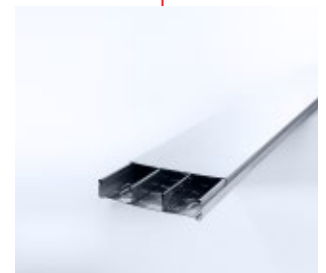

Canal de sol noyee avec couvercle page 151-152

SYSTÈMES DE GAINES DE SOL NOYÉES POUR SOLS EN TAPIS (LINOLÉUM) - BOÎTES DE SOL EN POLYAMIDE

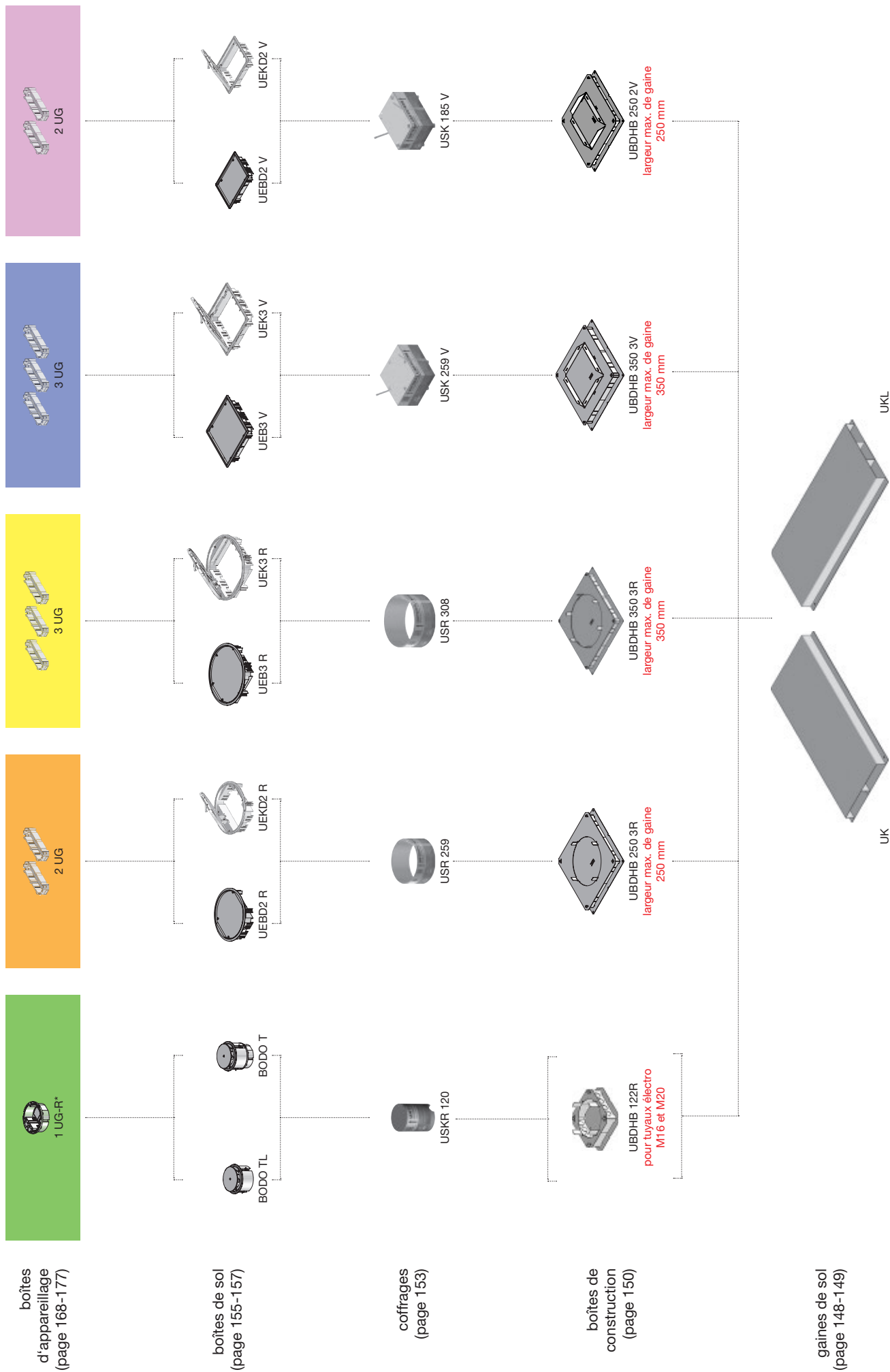

SYSTÈMES DE GAINES DE SOL NOYÉES POUR PARQUET ET CARRELAGE - BOÎTES DE SOL EN ACIER INOXYDABLE

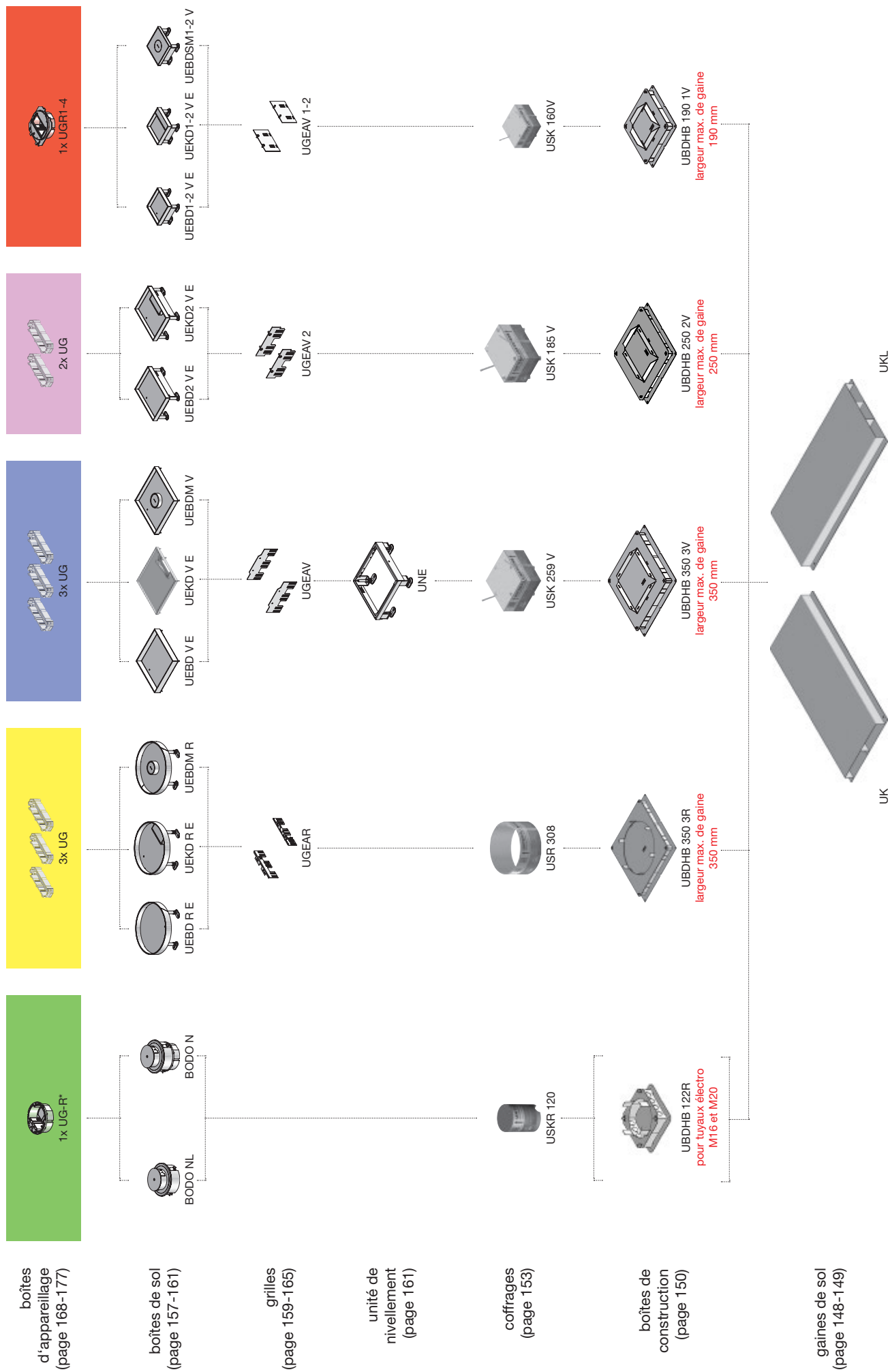

Canaux de sol au ras du sol

	type	référence	stock	page. catal.	groupe d'articles	prix en €
Système de gaines de sol ouvert						
	Acier galvanisé Sendzimir	200	UEBS 20S	A04	1407	168,02/m
	↔ 2 m	300	UEBS 30S	A04	1407	185,14/m
		400	UEBS 40S	A04	1407	202,26/m
Paroi latérale						
	Acier galvanisé Sendzimir	48-68	UEBSMSP 60S	A07	1407	18,39/m
	↔ 2 m	88-108	UEBSMSP 100S	A07	1407	22,82/m
Paroi latérale						
	Polyamide	48-68	UEBSMSP 60	A07	1407	21,56/m
	↔ 2 m	88-108	UEBSMSP 100	A07	1407	35,50/m
Bac de fond						
	Acier galvanisé Sendzimir	60-200	UEBSMSW 60-20S	A05	1407	26,63/m
	↔ 2 m	60-300	UEBSMSW 60-30S	A05	1407	31,07/m
		60-400	UEBSMSW 60-40S	A05	1407	36,14/m
		80-200	UEBSMSW 80-20S	A05	1407	28,52/m
		80-300	UEBSMSW 80-30S	A05	1407	33,60/m
		80-400	UEBSMSW 80-40S	A05	1407	39,32/m
		100-200	UEBSMSW 100-20S	A05	1407	31,07/m
		100-300	UEBSMSW 100-30S	A05	1407	36,14/m
		100-400	UEBSMSW 100-40S	A05	1407	43,75/m
		120-200	UEBSMSW 120-20S	A05	1407	33,60/m
		120-300	UEBSMSW 120-30S	A05	1407	36,14/m
		120-400	UEBSMSW 120-40S	A05	1407	43,75/m
Pied de nivellement						
	Acier galvanisé Sendzimir	60/110	UEBSST 80S	A07	1407	13,95/pc.
		100/150	UEBSST 150S	A08	1407	19,03/pc.
Embout						
	Acier galvanisé Sendzimir	60-200	UEBSES 60-20S	A11	1407	26,63/pc.
		60-300	UEBSES 60-30S	A11	1407	29,16/pc.
		60-400	UEBSES 60-40S	A11	1407	31,70/pc.
		100-200	UEBSES 100-20S	A11	1407	27,90/pc.
		100-300	UEBSES 100-30S	A11	1407	30,44/pc.
		100-400	UEBSES 100-40S	A11	1407	32,96/pc.
Dérivation						
	Acier galvanisé Sendzimir	200	UEBSMA 20S	A09	1407	33,73/pc.
		300	UEBSMA 30S	A09	1407	34,37/pc.
		400	UEBSMA 40S	A09	1407	35,00/pc.

Canaux de sol au ras du sol

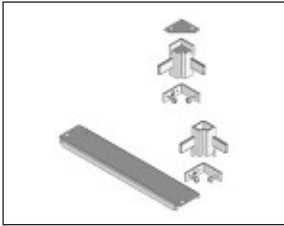
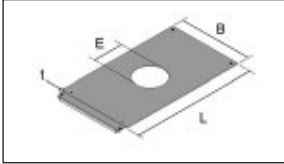
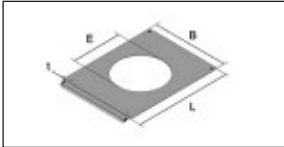
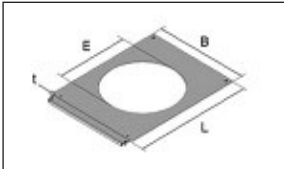
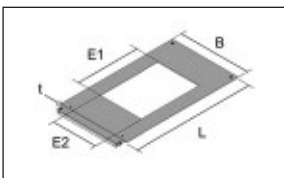
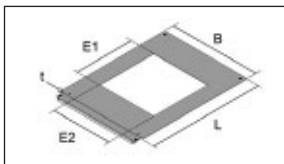
	type	référence	stock	page. catal.	groupe d'articles	prix en €
	Pièce d'angle					
	Acier galvanisé Sendzimir					
	200	UEBSMB 20S		A09	1407	33,73/pc.
	300	UEBSMB 30S		A09	1407	34,37/pc.
	400	UEBSMB 40S		A10	1407	35,00/pc.
	Couvercle de montage, trou diamètre 122					
	Acier galvanisé Sendzimir					
	200	UEBSMD-122R 20S		A05	1407	57,07/pc.
	↔ 0,5 m	300	UEBSMD-122R 30S		A05	1407
	400	UEBSMD-122R 40S		A05	1407	69,76/pc.
	Couvercle de montage, trou diamètre 260					
	Acier galvanisé Sendzimir					
	400	UEBSMD-260R 40S		A05	1407	69,76/pc.
	↔ 0,5 m					
	Couvercle de montage, trou diamètre 307					
	Acier galvanisé Sendzimir					
	400	UEBSMD-307R 40S		A05	1407	69,76/pc.
	↔ 0,5 m					
	Couvercle de montage, trou 185 x 260					
	Acier galvanisé Sendzimir					
	300	UEBSMD-185V 30S		A06	1407	63,41/pc.
	↔ 0,5 m	400	UEBSMD-185V 40S		A06	1407
	Couvercle de montage, trou 261 x 261					
	Acier galvanisé Sendzimir					
	400	UEBSMD-260V 40S		A06	1407	69,76/pc.
	↔ 0,5 m					

Canaux de sol pour charges lourdes

	type	référence	stock	page. catal.	groupe d'articles	prix en €	
Base canal de sol							
	Acier galvanisé Sendzimir						
			UBK	UBK 100-20S	A18	1401	51,56/m
	↔ 3 m		UBK	UBK 100-30S	A18	1401	61,70/m
			UBK	UBK 100-40S	A18	1401	74,82/m
			UBK	UBK 135-20S	A18	1401	57,07/m
			UBK	UBK 135-30S	A18	1401	68,48/m
			UBK	UBK 135-40S	A18	1401	81,59/m
			UBK	UBK 170-20S	A18	1401	63,41/m
			UBK	UBK 170-30S	A18	1401	74,39/m
		UBK	UBK 170-40S	A18	1401	86,22/m	
Couvercle pour canal de sol							
	Acier galvanisé à chaud						
			UBKD	UBKD5 25F	A18	1401	318,29/m
	↔ 1 m		UBKD	UBKD5 35F	A18	1401	358,86/m
			UBKD	UBKD5 45F	A18	1401	401,98/m
			UBKD	UBKD8 25F	A18	1401	381,69/m
			UBKD	UBKD8 35F	A18	1401	451,43/m
			UBKD	UBKD8 45F	A18	1401	516,11/m
			UBKD	UBKD10 25F	A18	1401	421,01/m
			UBKD	UBKD10 35F	A18	1401	511,03/m
		UBKD	UBKD10 45F	A18	1401	593,46/m	
Profilé latéral							
	Acier galvanisé à chaud						
			UBKPR	UBKPR5F	A19	1401	61,70/m
	↔ 3 m		UBKPR	UBKPR8F	A19	1401	80,31/m
		UBKPR	UBKPR10F	A19	1401	96,80/m	
Embout							
	Acier galvanisé Sendzimir						
			UBKEB	UBKEB 100-20S	A20	1401	28,73/pc.
			UBKEB	UBKEB 100-30S	A20	1401	32,85/pc.
			UBKEB	UBKEB 100-40S	A20	1401	34,94/pc.
			UBKEB	UBKEB 135-20S	A20	1401	30,82/pc.
			UBKEB	UBKEB 135-30S	A20	1401	34,94/pc.
			UBKEB	UBKEB 135-40S	A20	1401	36,90/pc.
			UBKEB	UBKEB 170-20S	A20	1401	32,85/pc.
			UBKEB	UBKEB 170-30S	A20	1401	36,90/pc.
		UBKEB	UBKEB 170-40S	A20	1401	39,00/pc.	
Profilé pour courbe intérieure							
	Acier galvanisé à chaud						
			UBKIB	UBKIB5F	A20	1401	143,30/pc.
			UBKIB	UBKIB8F	A20	1401	183,87/pc.
		UBKIB	UBKIB10F	A20	1401	224,46/pc.	
Profilé pour courbe extérieure							
	Acier galvanisé à chaud						
			UBKAB	UBKAB5F	A20	1401	166,12/pc.
			UBKAB	UBKAB8F	A20	1401	216,84/pc.
		UBKAB	UBKAB10F	A20	1401	267,57/pc.	

Canaux de sol pour charges lourdes

	type	référence	stock	page. catal.	groupe d'articles	prix en €
	Accouplement (base canal de sol)					
	Acier galvanisé Sendzimir					
	UBKV	UBKV 100S	A21	1401	2,73/pc.	
	UBKV	UBKV 135S	A21	1401	3,55/pc.	
	UBKV	UBKV 170S	A21	1401	4,43/pc.	
	Teneur de distance					
	Acier galvanisé à chaud					
	UBKDB	UBKDB5 25F	A21	1401	4,19/pc.	
	UBKDB	UBKDB5 35F	A21	1401	4,76/pc.	
	UBKDB	UBKDB5 45F	A21	1401	6,09/pc.	
	UBKDB	UBKDB8 25F	A21	1401	4,43/pc.	
	UBKDB	UBKDB8 35F	A21	1401	5,21/pc.	
	UBKDB	UBKDB8 45F	A21	1401	6,42/pc.	
	Cloison de séparation					
	Acier galvanisé Sendzimir					
	UBKTR	UBKTR 100S	A14	1401	5,27/m	
	UBKTR	UBKTR 135S	A14	1401	6,13/m	
	UBKTR	UBKTR 170S	A14	1401	7,00/m	

Gaines de sol noyées fermées

	type	référence	stock	page. catal.	groupe d'articles	prix en €	
Gaine de sol fermée, 2 compartiments							
	Acier galvanisé Sendzimir						
		↔ 3 m	UK	UK 2-28-190S	✓	B04 1403	44,39/m
			UK	UK 2-28-250S	✓	B04 1403	48,19/m
			UK	UK 2-28-350S	✓	B04 1403	67,21/m
			UK	UK 2-38-190S	✓	B04 1403	46,49/m
			UK	UK 2-38-250S	✓	B04 1403	50,72/m
			UK	UK 2-38-350S	✓	B04 1403	68,91/m
			UK	UK 2-48-190S		B04 1403	47,76/m
			UK	UK 2-48-250S		B04 1403	52,42/m
		UK	UK 2-48-350S		B04 1403	70,59/m	
Gaine de sol fermée, 3 compartiments							
	Acier galvanisé Sendzimir						
		↔ 3 m	UKL	UKL 3-28-250S		B04 1403	49,45/m
			UKL	UKL 3-28-350S		B04 1403	67,64/m
			UKL	UKL 3-38-250S	✓	B04 1403	55,37/m
			UKL	UKL 3-38-350S	✓	B04 1403	69,76/m
			UKL	UKL 3-48-250S	✓	B04 1403	60,87/m
		UKL	UKL 3-48-350S	✓	B04 1403	71,86/m	
Etrier de fixation							
	Acier galvanisé Sendzimir						
		UB	UB 28-190S	✓	B05 1403	7,22/pc.	
		UB	UB 28-250S	✓	B05 1403	7,42/pc.	
		UB	UB 28-350S	✓	B05 1403	8,31/pc.	
		UB	UB 38-190S	✓	B05 1403	7,42/pc.	
		UB	UB 38-250S	✓	B05 1403	7,54/pc.	
		UB	UB 38-350S	✓	B05 1403	8,31/pc.	
		UB	UB 48-190S		B05 1403	7,54/pc.	
		UB	UB 48-250S	✓	B05 1403	7,80/pc.	
	UB	UB 48-350S	✓	B05 1403	8,50/pc.		
Pièce de montée, 2 compartiments							
	Acier galvanisé Sendzimir						
		UVB	UVB 2-28-190S	✓	B05 1403	56,04/pc.	
		UVB	UVB 2-28-250S	✓	B05 1403	60,69/pc.	
		UVB	UVB 2-28-350S	✓	B05 1403	68,10/pc.	
		UVB	UVB 2-38-190S	✓	B05 1403	57,14/pc.	
		UVB	UVB 2-38-250S	✓	B05 1403	61,32/pc.	
		UVB	UVB 2-38-350S	✓	B05 1403	68,79/pc.	
		UVB	UVB 2-48-190S		B05 1403	59,80/pc.	
		UVB	UVB 2-48-250S		B05 1403	64,29/pc.	
	UVB	UVB 2-48-350S		B05 1403	71,84/pc.		
Pièce de montée, 3 compartiments							
	Acier galvanisé Sendzimir						
		UVB	UVB 3-28-250S		B05 1403	67,28/pc.	
		UVB	UVB 3-28-350S		B05 1403	80,41/pc.	
		UVB	UVB 3-38-250S	✓	B05 1403	72,28/pc.	
		UVB	UVB 3-38-350S	✓	B05 1403	84,33/pc.	
		UVB	UVB 3-48-250S	✓	B05 1403	76,72/pc.	
	UVB	UVB 3-48-350S	✓	B05 1403	96,70/pc.		

Gaines de sol noyées fermées

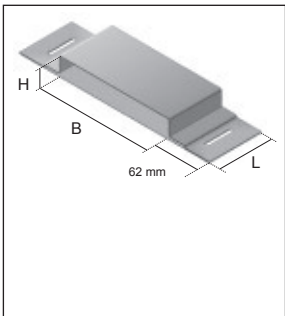
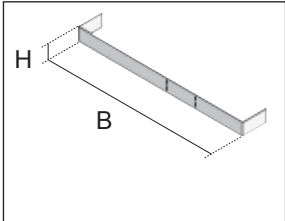
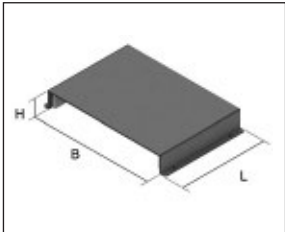
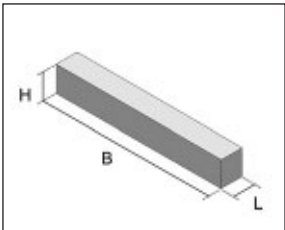
	type	référence	stock	page. catal.	groupe d'articles	prix en €	
	Manchon de fixation						
	Acier galvanisé Sendzimir						
	UM	UM 28-190S		B06	1403	11,79/pc.	
	UM	UM 28-250S		B06	1403	12,50/pc.	
	UM	UM 28-350S		B06	1403	13,89/pc.	
	UM	UM 38-190S		B06	1403	11,98/pc.	
	UM	UM 38-250S		B06	1403	12,75/pc.	
	UM	UM 38-350S		B06	1403	14,21/pc.	
	UM	UM 48-190S		B06	1403	12,23/pc.	
	UM	UM 48-250S		B06	1403	12,86/pc.	
	UM	UM 48-350S		B06	1403	14,32/pc.	
À utiliser aux endroits avec joints d'expansion.							
	Embout						
	Acier galvanisé Sendzimir						
	UE	UE 28-350S		B06	1403	14,21/pc.	
	UE	UE 38-350S		B06	1403	16,10/pc.	
	UE	UE 48-350S		B06	1403	18,65/pc.	
	Cloison anti-incendie						
	Acier galvanisé Sendzimir						
		28-350	UKBS 28-350S		B11	1402	535,12/pc.
		38-350	UKBS 38-350S		B11	1402	557,95/pc.
	48-350	UKBS 48-350S		B11	1402	583,32/pc.	
	Bouchon en mousse Easyfoam						
	Polycarbonate						
		30-390	UKBSR 28-350S		B11	1402	22,00/pc.
		40-390	UKBSR 38-350S		B11	1402	22,97/pc.
	50-390	UKBSR 48-350S		B11	1402	24,09/pc.	

Boîtes de construction vides

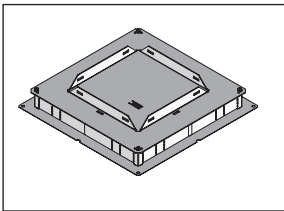
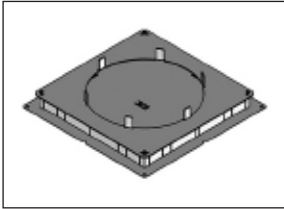
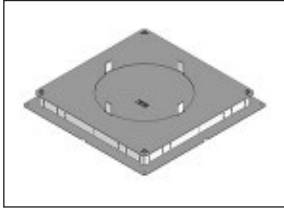
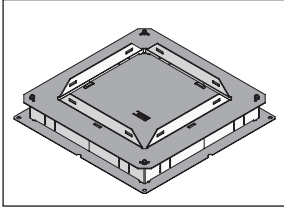
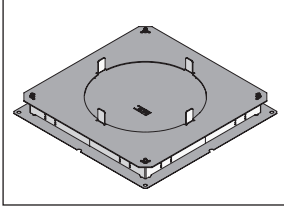
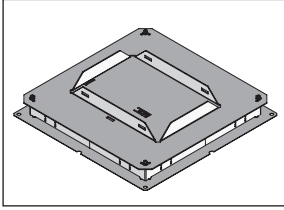
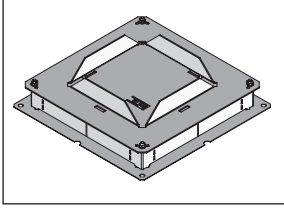
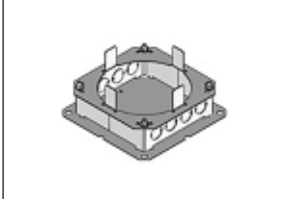
	type	référence	stock	page. catal.	groupe d'articles	prix en €
	Boîte de construction vide					
	Acier galvanisé Sendzimir	262x262	UBDHB350 28-259V	✓	B07 1402	118,31/pc.
		262x262	UBDHB350 38-259V	✓	B07 1402	122,37/pc.
		262x262	UBDHB350 48-259V	✓	B07 1402	129,35/pc.
	Boîte de construction vide					
	Acier galvanisé Sendzimir	Ø310	UBDHB350 28-308R	✓	B07 1402	121,68/pc.
		Ø310	UBDHB350 38-308R		B07 1402	126,04/pc.
		Ø310	UBDHB350 48-308R		B07 1402	130,61/pc.
	Boîte de construction vide					
	Acier galvanisé Sendzimir	Ø260	UBDHB350 28-259R		B08 1402	117,84/pc.
		Ø260	UBDHB350 38-259R		B08 1402	122,54/pc.
		Ø260	UBDHB350 48-259R		B08 1402	127,03/pc.
	Boîte de construction vide					
	Acier galvanisé Sendzimir	262x262	UBDHB250 28-259V	✓	B08 1402	109,14/pc.
		262x262	UBDHB250 38-259V	✓	B08 1402	112,17/pc.
		262x262	UBDHB250 48-259V		B08 1402	115,22/pc.
	Boîte de construction vide					
	Acier galvanisé Sendzimir	Ø260	UBDHB250 28-259R		B09 1402	109,95/pc.
		Ø260	UBDHB250 38-259R		B09 1402	113,06/pc.
		Ø260	UBDHB250 48-259R		B09 1402	115,97/pc.
	Boîte de construction vide					
	Acier galvanisé Sendzimir	187x262	UBDHB250 28-185V	✓	B09 1402	100,88/pc.
		187x262	UBDHB250 38-185V	✓	B09 1402	104,23/pc.
		187x262	UBDHB250 48-185V		B09 1402	107,79/pc.
	Boîte de construction vide					
	Acier galvanisé Sendzimir	165x165	UBDHB190 28-160V	✓	B10 1402	96,13/pc.
		165x165	UBDHB190 38-160V	✓	B10 1402	96,88/pc.
		165x165	UBDHB190 48-160V		B10 1402	97,64/pc.
	Boîte de construction vide					
	Acier galvanisé Sendzimir	Ø123	UBDHB 38-122R	✓	B10 1406	65,18/pc.

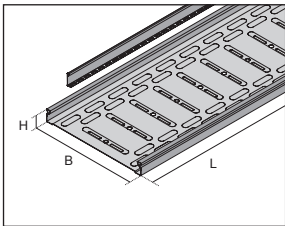
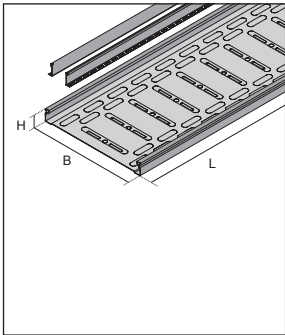
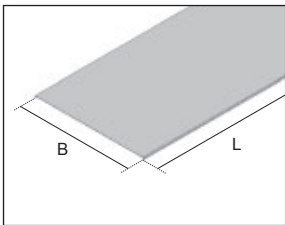
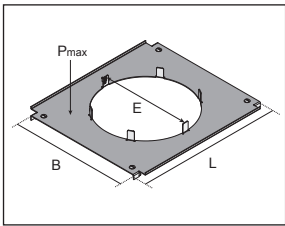
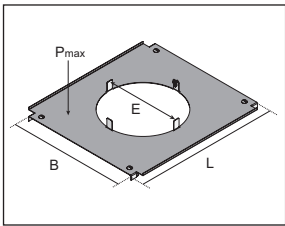
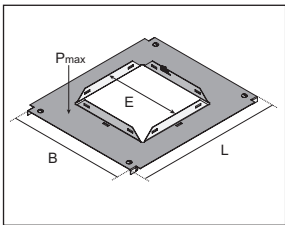
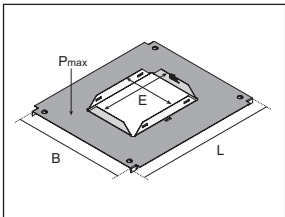

Canaux de sol avec couvercle

	type	référence	stock	page. catal.	groupe d'articles	prix en €	
	Base canal de sol, 2 compartiments						
	Acier galvanisé Sendzimir	UKR	UKR 35-30S		B14	1402	23,79/m
	↔ 3 m						
	Base canal de sol, 3 compartiments						
	Acier galvanisé Sendzimir	UKR	UKR 35-40S	✓	B14	1402	27,11/m
	↔ 3 m	UKR	UKR 35-50S	✓	B14	1402	33,30/m
		UKR	UKR 60-40S	✓	B14	1402	39,69/m
		UKR	UKR 60-50S	✓	B14	1402	45,65/m
		UKR	UKR 85-40S		B14	1402	57,49/m
		UKR	UKR 85-50S		B14	1402	63,41/m
		UKR	UKR 110-40S		B14	1402	62,13/m
	UKR	UKR 110-50S		B14	1402	74,82/m	
	Couvercle pour canal de sol						
	Acier galvanisé Sendzimir	UKD	UKD 30S		B14	1402	24,86/m
	↔ 3 m	UKD	UKD 40S	✓	B14	1402	28,54/m
		UKD	UKD 50S	✓	B14	1402	34,43/m
	Couvercle de montage						
	Acier galvanisé Sendzimir	Ø310	UKDA-308R 40S		B15	1402	59,73/pc.
		Ø310	UKDA-308R 50S		B15	1402	66,78/pc.
	Couvercle de montage						
	Acier galvanisé Sendzimir	Ø260	UKDA-260R 30S		B15	1402	53,38/pc.
		Ø260	UKDA-260R 40S		B15	1402	58,85/pc.
		Ø260	UKDA-260R 50S		B15	1402	66,06/pc.
	Couvercle de montage						
	Acier galvanisé Sendzimir	262x262	UKDA-260V 40S	✓	B15	1402	59,41/pc.
		262x262	UKDA-260V 50S	✓	B15	1402	66,44/pc.
	Couvercle de montage						
	Acier galvanisé Sendzimir	187x262	UKDA-185V 30S		B16	1402	44,97/pc.
		187x262	UKDA-185V 40S		B16	1402	52,24/pc.

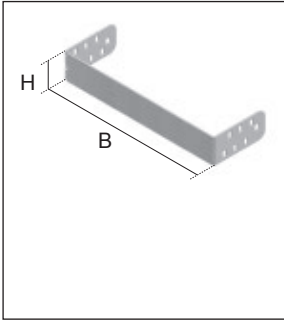
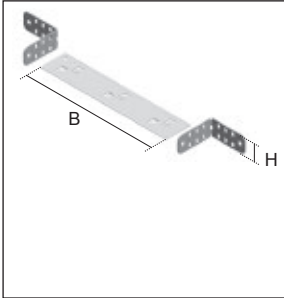
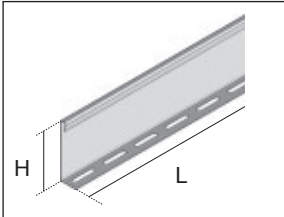
Canaux de sol avec couvercle

	type	référence	stock	page. catal.	groupe d'articles	prix en €
Embout						
	Acier galvanisé Sendzimir					
	UKEB	UKEB 35-30S		B16	1402	4,51/pc.
	UKEB	UKEB 35-40S	✓	B16	1402	5,07/pc.
	UKEB	UKEB 35-50S		B16	1402	6,72/pc.
	UKEB	UKEB 60-40S		B16	1402	7,60/pc.
	UKEB	UKEB 60-50S		B16	1402	9,25/pc.
	UKEB	UKEB 85-40S		B16	1402	10,53/pc.
	UKEB	UKEB 85-50S		B16	1402	13,06/pc.
	UKEB	UKEB 110-40S		B16	1402	14,32/pc.
UKEB	UKEB 110-50S		B16	1402	15,98/pc.	
Dérivation						
	Acier galvanisé Sendzimir					
	UKAZ	UKAZ 35-30S		B16	1402	sur demande
	UKAZ	UKAZ 35-40S	✓	B16	1402	11,79/pc.
	UKAZ	UKAZ 35-50S		B16	1402	12,50/pc.
	UKAZ	UKAZ 60-40S		B16	1402	12,37/pc.
	UKAZ	UKAZ 60-50S		B16	1402	13,78/pc.
	UKAZ	UKAZ 85-40S		B16	1402	19,03/pc.
	UKAZ	UKAZ 85-50S		B16	1402	19,03/pc.
	UKAZ	UKAZ 110-40S		B16	1402	19,48/pc.
UKAZ	UKAZ 110-50S		B16	1402	20,23/pc.	
Cloison de séparation						
	Acier galvanisé Sendzimir					
	UKTR	UKTR 35S		B17	1402	3,69/m
	UKTR	UKTR 60S		B17	1402	10,91/m
	UKTR	UKTR 85S		B17	1402	10,67/m
	UKTR	UKTR 110S		B17	1402	13,11/m

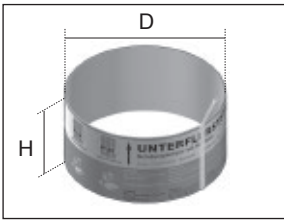
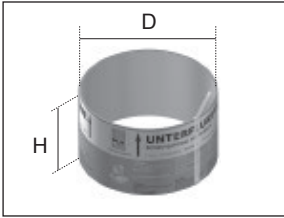
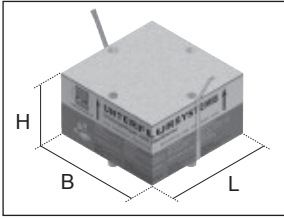
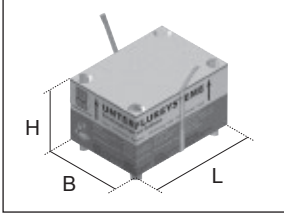
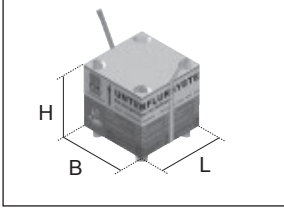

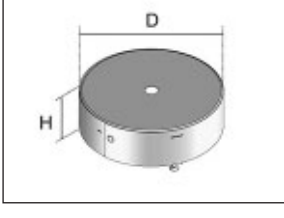
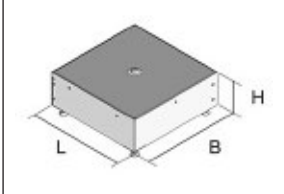
Coffrages

	type	référence	stock	page. catal.	groupe d'articles	prix en €
	Tube de coffrage					
	Carton	Ø308 USR 308-150 Ø308 USR 308-225	✓	B18 B18	1402 1402	13,44/pc. 23,97/pc.
	Tube de coffrage					
	Carton	Ø259 USR 259-150		B18	1402	12,37/pc.
	Corps de coffrage					
	Polystyrène	261x261 USK 259V-150 261x261 USK 259V-225	✓ ✓	B18 B18	1402 1402	16,30/pc. 25,30/pc.
	Corps de coffrage					
	Polystyrène	186x261 USK 185V-150	✓	B18	1402	13,06/pc.
	Corps de coffrage					
	Polystyrène	164x164 USK 160V-150	✓	B18	1402	10,97/pc.
	Corps de coffrage					
	Polystyrène	Ø122 USK 120R-82 Ø122 USK 120R-150	✓	B18 B18	1406 1406	6,47/pc. 7,91/pc.
	Tube de coffrage, rond, résistant à la chaleur					
	Acier galvanisé Sendzimir	Ø307 UNSKH 308R-100S		B18	1402	113,98/pc.
	Corps de coffrage, carré, résistant à la chaleur					
	Acier galvanisé Sendzimir	259x259 UNSKH 260V-100S		B19	1402	88,65/pc.

Accessoires

	type	référence	stock	page. catal.	groupe d'articles	prix en €
	Cheville à frapper Acier galvanisé cheville en PVC	UN 5/38	✓	B20	1402	13,48/bt.
	1 boîte = 50 pièces					
	Cheville à frapper Acier galvanisé cheville en acier	SNA 6x30/5	✓	B20	1402	168,66/bt.
	1 boîte = 100 pièces					
	Ruban adhésif avec tissu	UGKB		B20	1402	30,95/pc.
	1 pc. = 50 m					
	Adhésif bitumes	UBKM		B20	1402	38,23/pc.
	Languette de terre Acier galvanisé Sendzimir	UBDEL		B20	1402	10,86/pc.
	Borne de terre Acier galvanisé Sendzimir	UBDHB-Z		B20	1402	2,15/pc.

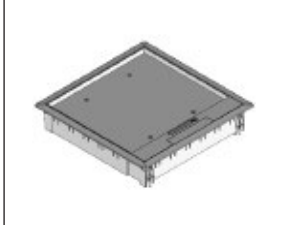
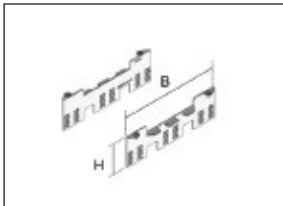

Boîtes de sol avec rebord

	type	référence	📦 stock	page. catal.	groupe d'articles	prix en €
	Boîte de tirage triple, ronde					
	Polyamide					
	gris	UEB3-R-G		C04	1402	45,88/pc.
	noir	UEB3-R-S		C04	1402	45,88/pc.
	Boîte de raccordement triple, ronde, sortie avec brosse					
	Polyamide					
	gris	UEK3-R-G		C04	1402	69,23/pc.
	noir	UEK3-R-S		C04	1402	69,23/pc.
	Boîte de tirage triple, carrée					
	Polyamide					
	gris	UEB3-V-G	✓	C06	1402	43,66/pc.
	noir	UEB3-V-S	✓	C06	1402	43,66/pc.
	Boîte de raccordement triple, carrée, sortie avec brosse					
	Polyamide					
	gris	UEK3-V-G	✓	C06	1402	57,07/pc.
	noir	UEK3-V-S	✓	C06	1402	57,07/pc.
	Set de montage pour boîte de raccordement, sortie avec brosse					
	Acier galvanisé Sendzimir					
	UGEA3	UGEA3-50-S	✓	C08	1402	10,65/set
	UGEA3	UGEA3-80-S	✓	C08	1402	12,55/set

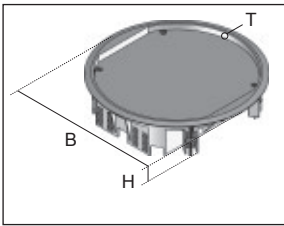
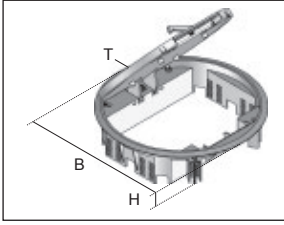
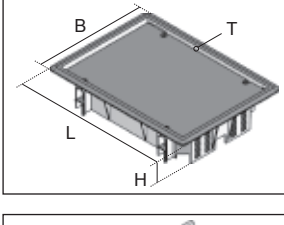
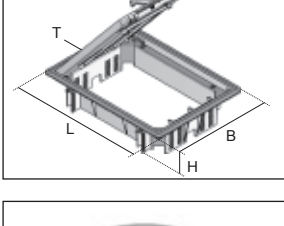
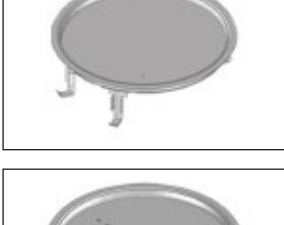
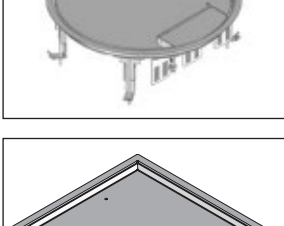
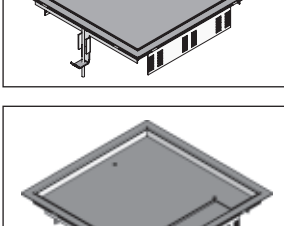
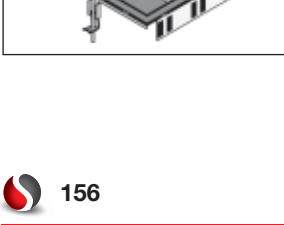

Boîtes de sol avec rebord

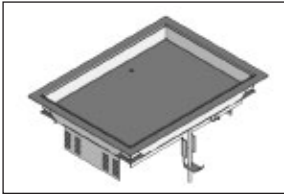
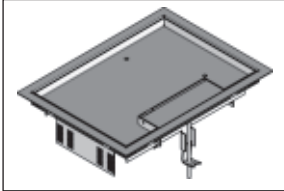
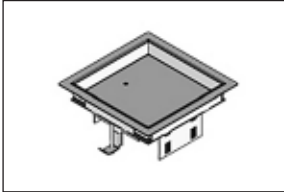
	type	référence	stock	page. catal.	groupe d'articles	prix en €
	Boîte de tirage double, ronde					
	Polyamide	gris noir	UEBD2-R-G UEBD2-R-S	C05 C05	1402 1402	33,68/pc. 33,68/pc.
	Boîte de raccordement double, ronde					
	Polyamide	gris noir	UEKD2-R-G UEKD2-R-S	C06 C06	1402 1402	52,88/pc. 52,88/pc.
	Boîte de tirage double, rectangulaire					
	Polyamide	gris noir	UEBD2-V-G UEBD2-V-S	C07 C07	1402 1402	36,77/pc. 36,77/pc.
	Boîte de raccordement double, rectangulaire					
	Polyamide	gris noir	UEKD2-V-G UEKD2-V-S	✓ ✓	C07 C07	1402 1402
	Boîte de tirage triple, ronde					
	INOX	12 mm	UEBDD 15-R E		C14	370,07/pc.
	Boîte de raccordement triple, ronde					
	INOX	12 mm	UEKDD 15-R E		C14	471,33/pc.
	Boîte de tirage triple, carrée					
	INOX	12 mm 22 mm	UEBDD 15-V E UEBDD 25-V E		C16 C16	1402 1402
	Boîte de raccordement triple, carrée					
	INOX	12 mm 22 mm	UEKDD 15-V E UEKDD 25-V E	✓ ✓	C17 C17	1402 1402

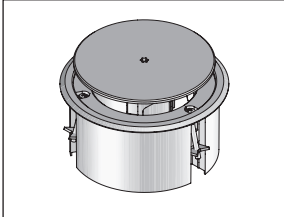

Boîtes de sol avec rebord

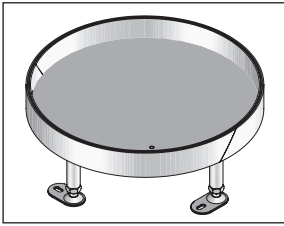
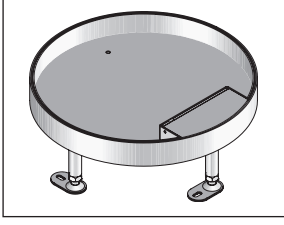
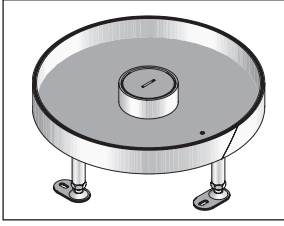
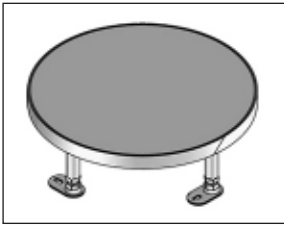
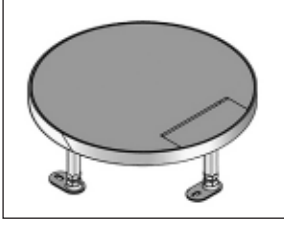
	type	référence	🌀 stock	page. catal.	groupe d'articles	prix en €	
	Boîte de tirage double, rectangulaire						
	INOX	12 mm 22 mm	UEBDD2 15-V E UEBDD2 25-V E		C15 C15	1402 1402	240,94/pc. 251,08/pc.
	Boîte de raccordement double, rectangulaire						
	INOX	12 mm 22 mm	UEKDD2 15-V E UEKDD2 25-V E	✓	C17 C17	1402 1402	339,85/pc. 361,40/pc.
	Boîte de tirage, carrée						
	INOX	12 mm 22 mm	UEBDD1-2 15-V E UEBDD1-2 25-V E		C15 C15	1402 1402	144,56/pc. 147,11/pc.
	Boîte de raccordement, carrée						
	INOX	12 mm 22 mm	UEKDD1-2 15-V E UEKDD1-2 25-V E		C16 C16	1402 1402	186,39/pc. 201,62/pc.
	Boîte de raccordement BODO, ronde						
	Aluminium		BODO NL	✓	C41	1406	318,53/pc.
		noir	BODO NL-SW		C41	1406	429,90/pc.
		chromé	BODO NL-CR		C41	1406	583,55/pc.
	Acier inoxydable	massif	BODO NL-E		C41	1406	1304,13/pc.
	Lation	massif	BODO NL-MMS		C41	1406	1057,14/pc.
	Boîte de raccordement BODO, ronde						
	ABS	gris	BODO TL-G	✓	C42	1406	55,26/pc.
		noir	BODO TL-S	✓	C42	1406	55,26/pc.

Boîtes de sol avec rebord de marquage

	type	référence	stock	page. catal.	groupe d'articles	prix en €
	Cassette de nivellement + couvercle aveugle, rond					
	INOX					
	2 kN	UEBD 15-R E	C20	1402	361,40/set	
	2 kN	UEBD 35-R E	C20	1402	414,66/set	
	Cassette de nivellement + couvercle avec sortie latérale, rond					
	INOX					
	2 kN	UEKD 15-R E	C21	1402	440,02/set	
	2 kN	UEKD 35-R E	C21	1402	503,43/set	
	Cassette de nivellement + couvercle avec sortie centrale, rond					
	INOX					
	2 kN	UEBDM 15-R-WD	C23	1402	453,97/set	
	2 kN	UEBDM 35-R-WD	C23	1402	526,25/set	
	Cassette de nivellement + couvercle rempli, aveugle, rond					
	INOX					
	4 kN	UEBD 15-RP E	C21	1402	528,79/set	
	Cassette de nivellement + couvercle rempli avec sortie latérale, rond					
	INOX					
	4 kN	UEKD 15-RP E	C22	1402	608,67/set	
	Cassette de nivellement + couvercle rempli avec sortie centrale, rond					
	INOX					
	4 kN	UEBDM 15-RP-WD	C24	1402	701,24/set	

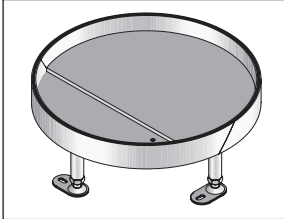
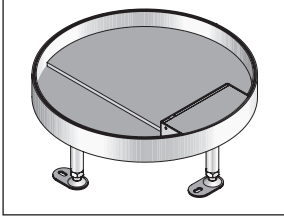
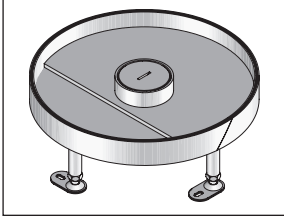
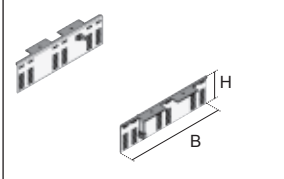
Boîtes de sol avec rebord de marquage

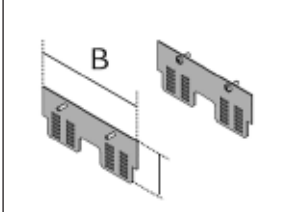
	type	référence	stock	page. catal.	groupe d'articles	prix en €
	Cassette de nivellement + couvercle aveugle, rond					
	INOX	20 kN	UEBDS 35-R6 E		C20 1402	544,00/set
	Cassette de nivellement + couvercle avec sortie latérale, rond					
	INOX	10 kN	UEKDS 35-R6 E		C22 1402	628,97/set
	Cassette de nivellement + couvercle avec sortie centrale, rond					
	INOX	20 kN	UEBDSM 35-R6-WD		C23 1402	646,73/set
	Set de montage, ronde					
	Acier galvanisé Sendzimir	UGEAR	UGEAR-50S	✓	C24 1402	37,72/set
		UGEAR	UGEAR-80S		C24 1402	39,69/set
	Cassette de nivellement + couvercle aveugle, rectangulaire					
	INOX	1,5 kN	UEBD2 15-V E		C26 1402	196,56/pc.
		1,5 kN	UEBD2 25-V E		C26 1402	213,02/pc.
	Cassette de nivellement + couvercle avec sortie latérale, rectangulaire					
	INOX	1,5 kN	UEKD2 15-V E		C28 1402	272,64/pc.
		1,5 kN	UEKD2 25-V E		C28 1402	298,00/pc.
	Set de montage, rectangulaire					
	Acier galvanisé Sendzimir	UGEAV	UGEAV2-50S	✓	C33 1402	10,65/set
		UGEAV	UGEAV2-80S		C33 1402	16,13/set



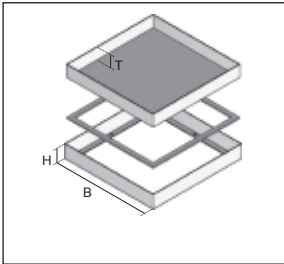
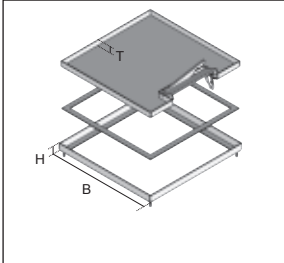
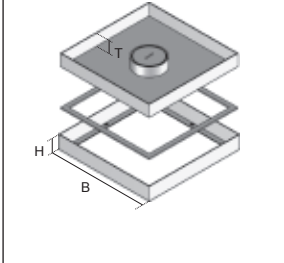
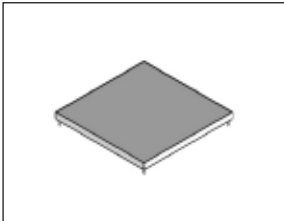
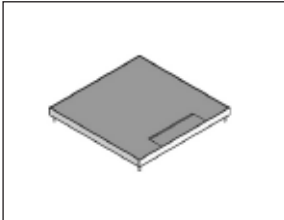
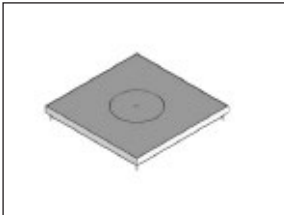

Boîtes de sol avec rebord de marquage

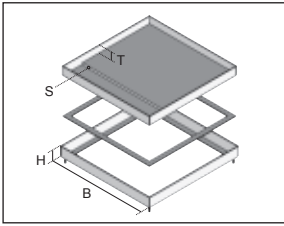
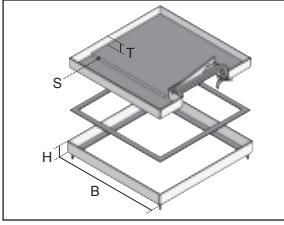
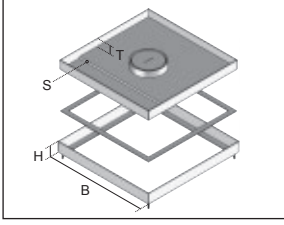
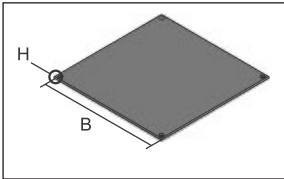
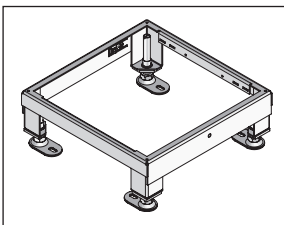
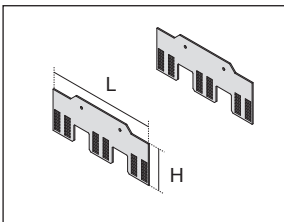
	type	référence	stock	page. catal.	groupe d'articles	prix en €	
	Cassette + couvercle aveugle, carré						
	INOX	2 kN	UEBD 15-V E	✓	C27	1402	172,46/set
		2 kN	UEBD 25-V E	✓	C27	1402	183,87/set
		2 kN	UEBD 35-V E		C27	1402	219,38/set
		2 kN	UEBD 45-V E		C27	1402	239,65/set
	Laiton	2 kN	UEBD 25-V MS		C27	1402	388,23/set
	2 kN	UEBD 35-V MS		C27	1402	419,49/set	
	Cassette + couvercle avec sortie latérale, carré						
	INOX	2 kN	UEKD 15-V E	✓	C29	1402	244,74/set
		2 kN	UEKD 25-V E	✓	C29	1402	258,69/set
		2 kN	UEKD 35-V E		C29	1402	277,71/set
		2 kN	UEKD 45-V E		C29	1402	298,00/set
	Laiton	2 kN	UEKD 25-V MS		C29	1402	526,47/set
	2 kN	UEKD 35-V MS		C29	1402	510,84/set	
	Cassette + couvercle avec sortie centrale, carré						
	INOX	2 kN	UEBDM 15-V-WD	✓	C30	1402	271,37/set
		2 kN	UEBDM 25-V-WD	✓	C30	1402	311,94/set
		2 kN	UEBDM 35-V-WD	✓	C30	1402	323,36/set
		2 kN	UEBDM 45-V-WD	✓	C30	1402	330,97/set
	Laiton	2 kN	UEBDM 25-V-WD MS		C30	1402	526,47/set
	2 kN	UEBDM 35-V-WD MS		C30	1402	614,20/set	
	Cassette + couvercle aveugle, rempli, carré						
	INOX	4 kN	UEBD 15-VP E		C28	1402	280,24/set
	Cassette + couvercle rempli avec sortie latérale, carré						
	INOX	4 kN	UEKD 15-VP E		C30	1402	356,32/set
	Cassette + couvercle rempli avec sortie centrale, carré						
	INOX	4 kN	UEBDM 15-VP-WD		C31	1402	443,83/set
		20 kN	UEBDSM 15-VP8-WD		C32	1402	544,83/set

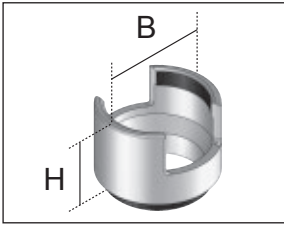

Boîtes de sol avec rebord de marquage

	type	référence	stock	page. catal.	groupe d'articles	prix en €
	Cassette + couvercle aveugle, carré					
	INOX					
	10 kN	UEBDS 25-V6 E		C27	1402	224,46/set
	10 kN	UEBDS 35-V6 E		C27	1402	261,22/set
	10 kN	UEBDS 45-V6 E		C27	1402	281,51/set
	20 kN	UEBDS 35-V8 E		C27	1402	263,75/set
	20 kN	UEBDS 45-V8 E		C27	1402	284,05/set
	Cassette + couvercle avec sortie latérale, carré					
	INOX					
	10 kN	UEKDS 25-V6 E		C29	1402	299,27/set
	10 kN	UEKDS 35-V6 E		C29	1402	318,29/set
	10 kN	UEKDS 45-V6 E		C29	1402	338,57/set
	Cassette + couvercle avec sortie centrale, carré					
	INOX					
	10 kN	UEBDSM 25-V6-WD		C31	1402	369,01/set
	10 kN	UEBDSM 35-V6-WD		C31	1402	377,89/set
	10 kN	UEBDSM 45-V6-WD		C31	1402	394,37/set
	20 kN	UEBDSM 35-V8-WD		C31	1402	381,69/set
	20 kN	UEBDSM 45-V8-WD		C31	1402	399,45/set
	Plaque aveugle, carrée					
	Acier galvanisé Sendzimir		UBP-V 4S		C26	1402
	Unité de nivellement, aveugle					
	Acier galvanisé Sendzimir					
	UNE	UNE 260V-30S	✓	C32	1402	83,25/pc.
	UNE	UNE 260V-60S	✓	C32	1402	85,04/pc.
	UNE	UNE 260V-100S	✓	C32	1402	87,69/pc.
	UNE	UNE 260V-155S	✓	C32	1402	98,39/pc.
	UNE	UNE 260V-210S	✓	C32	1402	119,01/pc.
	Set de montage, carré					
	Acier galvanisé Sendzimir					
	UGEAV	UGEAV-50S	✓	C33	1402	10,65/set
	UGEAV	UGEAV-80S	✓	C33	1402	12,55/set



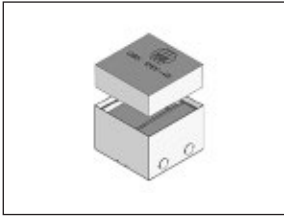
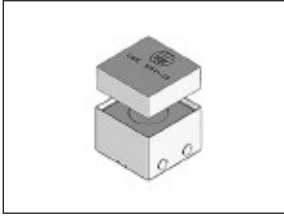

Boîtes de sol avec rebord de marquage

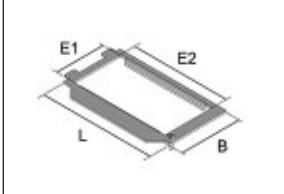
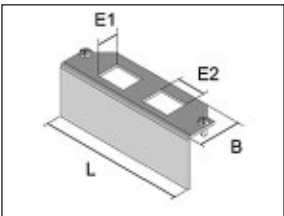
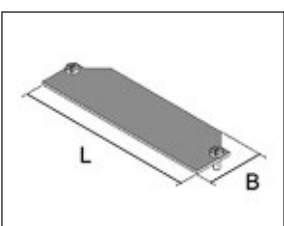
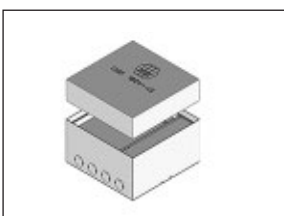
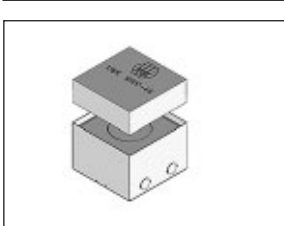
	type	référence	📦 stock	page. catal.	groupe d'articles	prix en €
	Cylindre					
	Aluminium	naturel	UET-R-WD	✓	C35 1402	84,95/pc.
	Aluminium	laiton	UET-R-WD-MS		C35 1402	94,36/pc.
	INOX	massif	UET-R-WD E		C35 1402	229,52/pc.
	Couvercle pour cylindre					
	Aluminium	naturel	UETD-R-WD		C35 1402	84,02/pc.
	Laiton	massif	UETD-R-WD-MMS		C35 1402	165,24/pc.
	INOX	massif	UETD-R-WD E		C35 1402	163,57/pc.
	Cylindre					
	Aluminium	UET112	UET112-R-WD		C35 1402	94,59/pc.
	Couvercle pour cylindre					
	Aluminium	UETD112	UETD112-R-WD		C35 1402	90,15/pc.
	Ventouse					
		USH	USH 40		C37 1402	42,04/pc.

Boîtes de sol complètes avec rebord de marquage

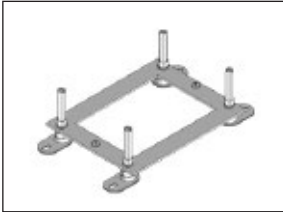
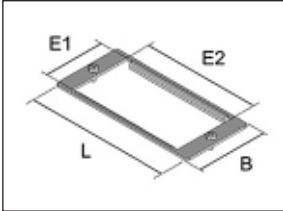
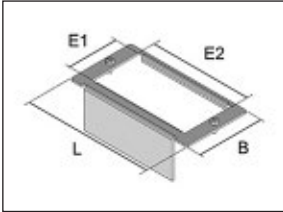
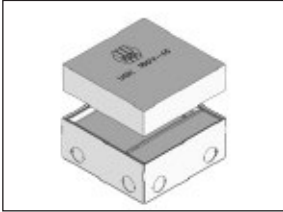
	type	référence	stock	page. catal.	groupe d'articles	prix en €	
Boîte de construction, coffrage et boîte de sol avec sortie latérale							
	INOX	125x125	UKE125 15-V E	✓	C56	1402	278,97/pc.
		125x125	UKE125 25-V E	✓	C56	1402	304,34/pc.
	Laiton	125x125	UKE125 25-V MS		C56	1402	469,18/pc.
Boîte de construction, coffrage et boîte de sol avec sortie centrale							
	INOX	125x125	UKE125 15-VP-WD	✓	C56	1402	399,45/pc.
Plateau de nivellement							
	Acier	25-70	UKENP 125S	✓	C61	1402	53,26/pc.
Support d'appareillage pour 2 modules (45x45)							
	Acier	UEP	UEP125-UST 2	✓	C61	1408	6,09/pc.
Support d'appareillage avec cloison de séparation pour 2 modules Keystone RJ45							
	Acier	UEP	UEP125-KS 2	✓	C61	1408	4,82/pc.
Support d'appareillage aveugle							
	Acier	UEP	UEP125-B	✓	C61	1408	2,39/pc.
Boîte de construction, coffrage et boîte de sol avec sortie latérale							
	INOX	160x160	UKE160 15-V E	✓	C58	1402	304,34/pc.
		160x160	UKE160 25-V E	✓	C58	1402	342,38/pc.
	Laiton	160x160	UKE160 25-V MS		C58	1402	513,56/pc.
Boîte de construction, coffrage et boîte de sol avec sortie centrale							
	INOX	160x160	UKE160 15-VP-WD	✓	C58	1402	418,46/pc.

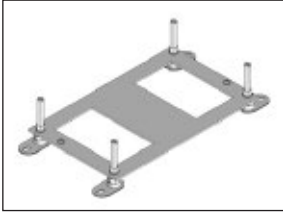
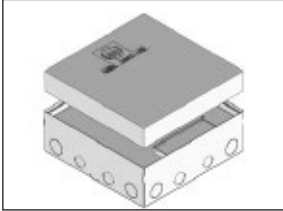
Boîtes de sol complètes avec rebord de marquage

	type	référence	 stock	page. catal.	groupe d'articles	prix en €	
	Plateau de nivellement						
	Acier	25-70	UKENP 160S	✓	C62	1402	55,93/pc.
	Support d'appareillage pour 2 modules (45x45)						
	Acier	UEP	UEP160-UST 2	✓	C61	1408	6,09/pc.
	Support d'appareillage avec cloison de séparation pour 2 modules 45x45						
	Acier	UEP	UEP160-UST 2-TR	✓	C61	1408	9,00/pc.
	Boîte de construction, coffrage et boîte de sol avec sortie latérale						
	INOX	160x160	UKEF160 15-V E		C57	1402	276,75/pc.
	Boîte de construction, coffrage et boîte de sol avec sortie latérale						
	INOX	184x258	UKE185 15-V E		C59	1402	358,83/pc.
		184x258	UKE185 25-V E		C59	1402	386,98/pc.
	Plateau de nivellement						
	Acier	25-70	UKENP 185S		C62	1402	50,61/pc.
	Boîte de construction, coffrage et boîte de sol avec sortie latérale						
	INOX	258x258	UKE260 15-V E		C60	1402	369,38/pc.
		258x258	UKE260 25-V E		C60	1402	398,70/pc.
	Plateau de nivellement						
	Acier	25-70	UKENP 260S		C62	1402	52,53/pc.

Boîtes de sol avec rebord de marquage

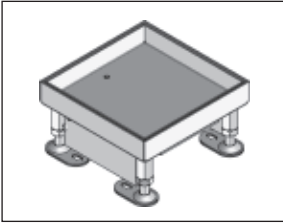
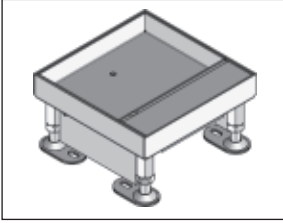
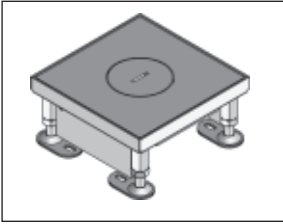
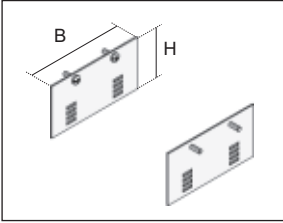
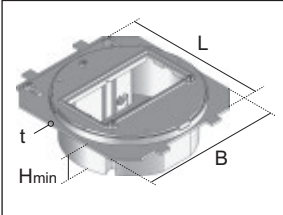
	type	référence	stock	page. catal.	groupe d'articles	prix en €
	Cassette de nivellement + couvercle aveugle (2x 45x45)					
	INOX					
	160x160	UEBD1-2 15-V E		C51	1402	158,51/pc.
	160x160	UEBD1-2 25-V E		C51	1402	168,66/pc.
	Cassette de nivellement + couvercle avec sortie latérale (2x 45x45)					
	INOX					
	160x160	UEKD1-2 15-V E		C51	1402	209,24/pc.
	160x160	UEKD1-2 25-V E		C51	1402	226,99/pc.
	Cassette de nivellement + couvercle avec sortie centrale (2x 45x45)					
	INOX					
	160x160	UEBDSM1-2 15-V8-WD	✓	C52	1402	310,68/pc.
	Set de montage, carré					
	Acier galvanisé Sendzimir					
	UGEAV	UGEAV1-2 50S	✓	C52	1402	10,65/set
	UGEAV	UGEAV1-2 80S		C52	1402	12,90/set
	Boîte d'appareillage ronde prémontée					
	Acier galvanisé Sendzimir					
	160x160	UGR1-4	✓	C52	1408	41,47/set

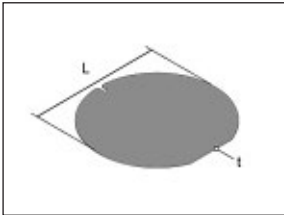
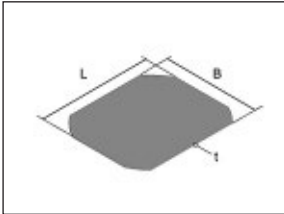
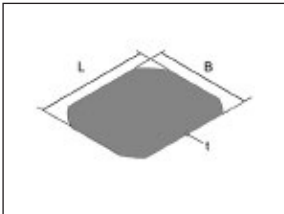
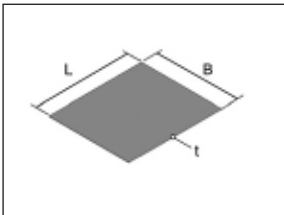
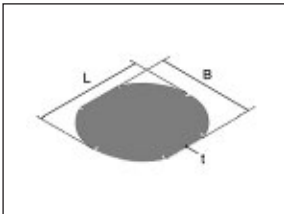
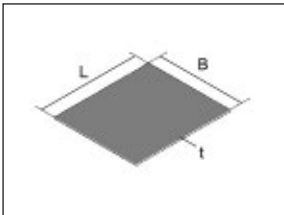
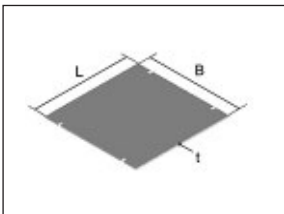
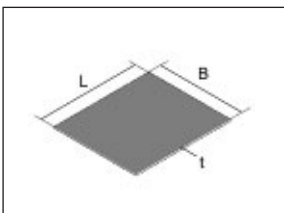

Remplissages pour boîtes de sol

	type	référence	 stock	page. catal.	groupe d'articles	prix en €
Remplissage pour couvercle aveugle, rond, en matière synthétique, triple						
	Carton	2 mm	UEB3-R 2	C08	1402	3,43/pc.
		5 mm	UEB3-R 5	C08	1402	4,04/pc.
	PVC	6 mm	UEB3-R 6K	C08	1402	18,79/pc.
Remplissage pour couvercle à charnière, rond, en matière synthétique, avec brosse, triple						
	Carton	2 mm	UEK3-R 2	C08	1402	3,67/pc.
		5 mm	UEK3-R 5	C08	1402	3,67/pc.
	PVC	6 mm	UEK3-R 6K	C08	1402	16,34/pc.
Remplissage pour couvercle aveugle, carré, en matière synthétique, triple						
	Carton	2 mm	UEB3-V 2	C08	1402	3,36/pc.
		5 mm	UEB3-V 5	C08	1402	3,36/pc.
	PVC	6 mm	UEB3-V 6K	C08	1402	14,82/pc.
Remplissage pour couvercle à charnière, carré, en matière synthétique, avec brosse, triple						
	Carton	2 mm	UEK3-V 2	C09	1402	2,28/pc.
		5 mm	UEK3-V 5	C09	1402	2,28/pc.
	PVC	6 mm	UEK3-V 6K	C09	1402	12,89/pc.
Remplissage pour couvercle aveugle, rond, en matière synthétique, double						
	Carton	3 mm	UEBD2-R 3	C09	1402	3,05/pc.
Remplissage pour couvercle à charnière, rond, en matière synthétique, double						
	Carton	3 mm	UEKD2-R 3	C10	1402	3,30/pc.
Remplissage pour couvercle aveugle, carré, en matière synthétique, double						
	Carton	3 mm	UEBD2-V 3	C10	1402	3,17/pc.
Remplissage pour couvercle à charnière, carré, en matière synthétique, double						
	Carton	3 mm	UEKD2-V 3	C10	1402	1,89/pc.

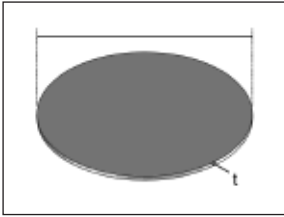
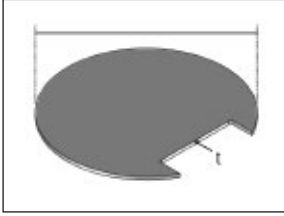
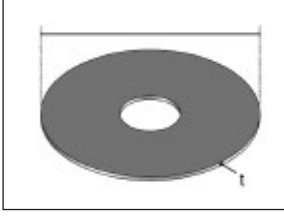
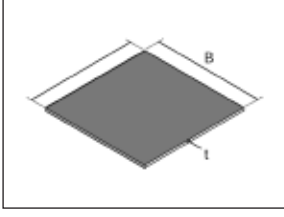
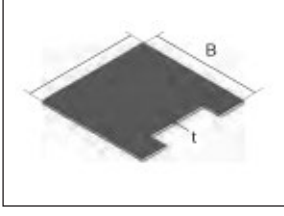
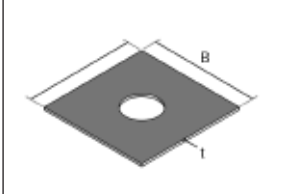
Remplissages pour boîtes de sol

	type	référence	stock	page. catal.	groupe d'articles	prix en €
	Remplissage pour couvercle aveugle triple, rond, en inox					
	PVC	6 mm	UEBDE3-R 6		C34 1402	30,18/pc.
	Remplissage pour couvercle avec sortie latérale triple, rond, en inox					
	PVC	6 mm	UEKDE3-R 6		C34 1402	32,22/pc.
	Remplissage pour couvercle avec sortie centrale triple, rond, en inox					
	PVC	6 mm	UEBDME3-R 6		C34 1402	38,42/pc.
	Remplissage pour couvercle aveugle triple en inox, carré					
	PVC	6 mm	UEBDE3-V 6	✓	C34 1402	14,46/pc.
	Remplissage pour couvercle avec sortie latérale triple, rond, en inox					
	PVC	6 mm	UEKDE3-V 6		C34 1402	18,77/pc.
	Remplissage pour couvercle avec sortie centrale triple en inox, carré					
	PVC	6 mm	UEBDME3-V 6	✓	C35 1402	27,13/pc.

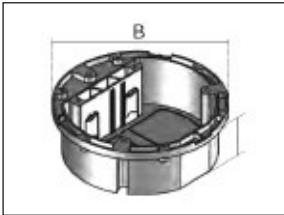
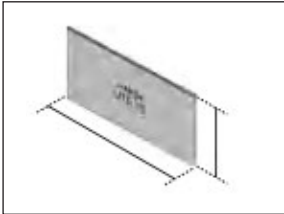
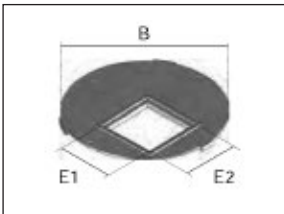
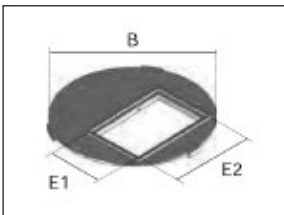
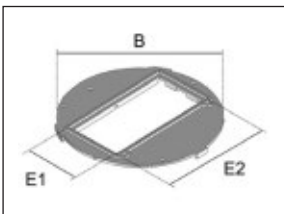
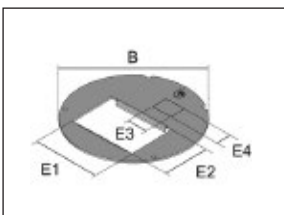
Boîtes d'appareillage et plaques de recouvrement

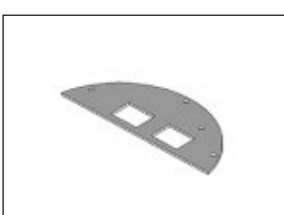
	type	référence	stock	page. catal.	groupe d'articles	prix en €
Boîte d'appareillage, ronde						
	ABS	UG-R	UG-R	✓	D04 1406	8,50/pc.
Cloison de séparation						
	ABS	UTG	UTG 75	✓	D04 1406	1,72/pc.
Plaque de recouvrement pour 2 x 45x22,5 mm						
	ABS	UARM	UARM-2-1 118	✓	D04 1406	2,48/pc.
Plaque de recouvrement pour 3 x 45x22,5 mm						
	ABS	UARM	UARM-3-1 118	✓	D04 1406	2,41/pc.
Plaque de recouvrement pour 4 x 45x22,5 mm						
	ABS	UARM	UARM-4-1 118	✓	D04 1406	3,65/pc.
Plaque de recouvrement pour 3 x 45x22,5 mm + 1 x Keystone						
	ABS	UARM	UARM-3-KS1 118S		D05 1406	11,67/pc.
Plaque de recouvrement pour RJ45 et TV						
	Acier	UBE	UBE-AMPSL-TV		D05 1406	13,13/pc.
Plaque de recouvrement pour 2 x RJ45 (Keystone)						
	Acier	UBE	UBE-KS 2		D05 1406	13,13/pc.

Boîtes d'appareillage et plaques de recouvrement

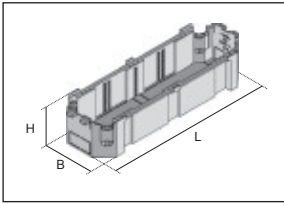
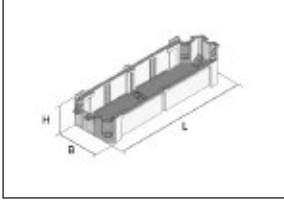
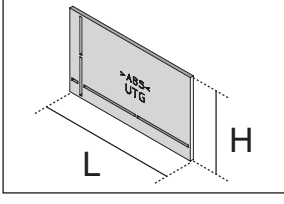
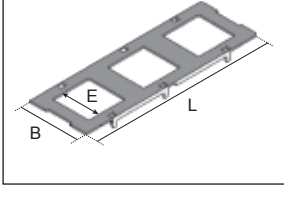
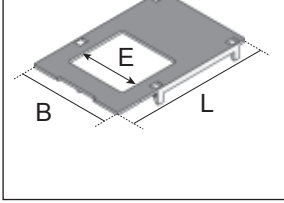
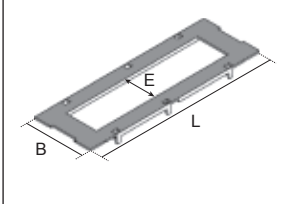
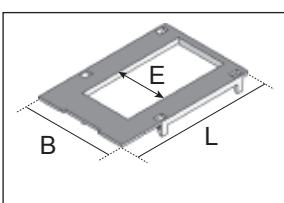
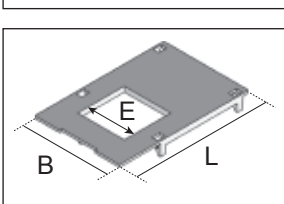
	type	référence	stock	page. catal.	groupe d'articles	prix en €	
Boîte d'appareillage, rectangulaire, 46x74x226							
	ABS	UG	✓	D06	1408	5,07/pc.	
Boîte d'appareillage, rectangulaire, 38x74x225							
	ABS	UG3		D06	1408	5,07/pc.	
Cloison de séparation							
	ABS	UTG		D06	1408	1,51/pc.	
Plaque de recouvrement 3x (50x50)							
	ABS	UA	UA-3-1 226	D06	1408	sur demande	
Plaque de recouvrement 1x (50x50)							
	ABS	UA	UA-1-1 113	D07	1408	sur demande	
Plaque de recouvrement 4x (45x45)							
	ABS	UAM	UAM-4-1 226	✓	D07	1408	2,98/pc.
Plaque de recouvrement 2x (45x45)							
	ABS	UAM	UAM-2-1 113	✓	D07	1408	1,72/pc.
Plaque de recouvrement 1x (45x45)							
	ABS	UAM	UAM-1-1 113	✓	D07	1408	1,89/pc.

Boîtes d'appareillage et plaques de recouvrement

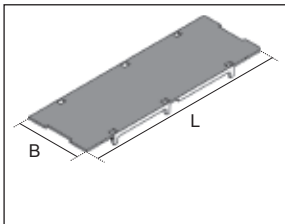
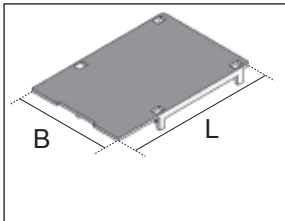
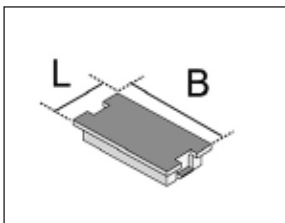
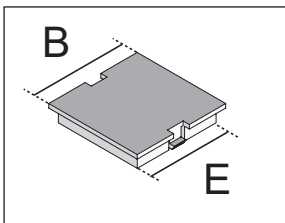
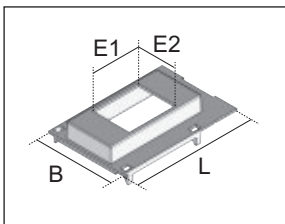
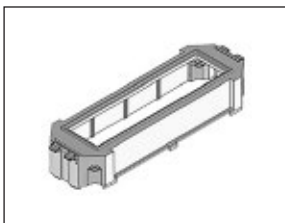
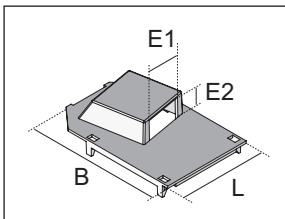
	type	référence	stock	page. catal.	groupe d'articles	prix en €
Plaque de recouvrement 1x aveugle						
	ABS	UA-B UA-B 226	✓	D12	1408	2,78/pc.
Plaque de recouvrement 1/2x aveugle						
	ABS	UA-B UA-B 113	✓	D12	1408	1,51/pc.
Obturateur						
	ABS	UAA UAA-B 22	✓	D35	1408	1,40/pc.
Obturateur						
	ABS	UAA UAA-B 45	✓	D07	1408	1,46/pc.
Plaque de recouvrement pour disjoncteur 2P						
	ABS	UALS UALS-2-1 113		D07	1408	16,18/pc.
Boîte d'appareillage ouverte, rectangulaire						
	ABS	UG45-4	✓	D12	1408	5,83/pc.
Plaque de recouvrement pour connecteur rapide						
	ABS	UAVS UAVS-1-1 113		D12	1408	3,05/pc.







Boîtes d'appareillage et plaques de recouvrement

	type	référence	 stock	page. catal.	groupe d'articles	prix en €
	Technique lumière					
	Acier galvanisé Sendzimir	UGET	UGET-3-SCD 113	D08	1408	19,60/pc.
	Technique lumière					
	Acier galvanisé Sendzimir	UGET	UGET-3-SCS 113	D08	1408	19,60/pc.
	Technique lumière					
	Acier galvanisé Sendzimir	UGET	UGET-2-LCDM 113	D08	1408	18,26/pc.
	Technique de données					
	Acier galvanisé Sendzimir	UGET	UGET-2-BTR 113	D09	1408	18,26/pc.
	Technique de données					
	Acier galvanisé Sendzimir	UGET	UGET-2-COR 113	D09	1408	18,50/pc.
	Technique de données					
	Acier galvanisé Sendzimir	UGET	UGET-2-AMP 113	D09	1408	18,26/pc.
	Technique de données					
	Acier galvanisé Sendzimir	UGET	UGET-2-AMPSL 113	D09	1408	18,26/pc.
	Technique de données					
	Acier galvanisé Sendzimir	UGET	UGET-2-GG45 113	D10	1408	18,26/pc.

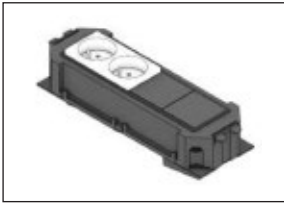
Boîtes d'appareillage et plaques de recouvrement

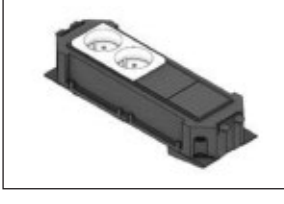
	type	référence	 stock	page. catal.	groupe d'articles	prix en €
	Technique de données					
Acier galvanisé Sendzimir	UGET	UGET-2-KR 113		D10	1408	18,26/pc.
	Technique de données					
Acier galvanisé Sendzimir	UGET	UGET-1-RM 113		D10	1408	18,26/pc.
	Technique de données					
Acier galvanisé Sendzimir	UGET	UGET-2-RMSC 113		D10	1408	18,26/pc.
	Technique de connexion					
Acier galvanisé Sendzimir	UGET	UGET-1-5PK 113		D10	1408	18,50/pc.
	Technique de connexion					
Acier galvanisé Sendzimir	UGET	UGET-2-3PK 113		D11	1408	19,27/pc.
	Technique audio et vidéo					
Acier galvanisé Sendzimir	UGET	UGET-2-KM 113		D08	1408	20,16/pc.
	Modules 45 x 45 mm					
Acier galvanisé Sendzimir	UGET	UGET-1-UST45 113		D08	1408	21,37/pc.
	Technique audio et vidéo					
Acier galvanisé Sendzimir	UGET	UGET-2-XLR 113		D09	1408	17,66/pc.

Boîtes d'appareillage et plaques de recouvrement

	type	référence	 stock	page. catal.	groupe d'articles	prix en €
	Boîte d'appareillage, prémontée, WAGO					
	2 prises blanches connectées à un connecteur noir	UG45FRWA-W2		D40	1408	47,58/pc.
	Boîte d'appareillage, prémontée, WAGO					
	2 prises rouges connectées à un connecteur blanc	UG45FRWA-R2		D40	1408	49,73/pc.
	Boîte d'appareillage, prémontée, WAGO					
	4 prises blanches connectées à un connecteur noir	UG45FRWA-W4		D40	1408	69,69/pc.
	Boîte d'appareillage, prémontée, WAGO					
	2 prises blanches connectées à un connecteur noir et 2 prises rouges connectées à un connecteur blanc	UG45FRWA-W2R2		D40	1408	79,01/pc.
	Boîte d'appareillage, prémontée Wieland					
	2 prises blanches connectées à un connecteur noir	UG45FRWI-W2	✓	D43	1408	47,58/pc.
	Boîte d'appareillage, prémontée Wieland					
	2 prises rouges connectées à un connecteur blanc	UG45FRWI-R2		D43	1408	49,73/pc.
	Boîte d'appareillage, prémontée Wieland					
	4 prises blanches connectées à un connecteur noir	UG45FRWI-W4	✓	D43	1408	69,69/pc.
	Boîte d'appareillage, prémontée Wieland					
	2 prises blanches connectées à un connecteur noir et 2 prises rouges connectées à un connecteur blanc	UG45FRWI-W2R2		D43	1408	79,01/pc.

Boîtes d'appareillage et plaques de recouvrement

	type	référence	stock	page. catal.	groupe d'articles	prix en €	
	Supports pour platines (3x UDEP)						
	Acier galvanisé Sendzimir	UGETD	UGETD-3 226	✓	D14	1408	25,94/pc.
			UGETD-UZ		D14	1408	12,63/pc.
	Technique lumière						
	Aluminium	UDEP	UDEP-SCD 4		D15	1408	4,56/pc.
	Technique lumière						
	Aluminium	UDEP	UDEP-SCS 4		D15	1408	4,56/pc.
	Technique de données						
	Aluminium	UDEP	UDEP-BTR 3		D16	1408	4,56/pc.
	Technique de données						
	Aluminium	UDEP	UDEP-COR 3		D16	1408	4,56/pc.
	Technique de données						
	Aluminium	UDEP	UDEP-HAR PL3		D16	1408	4,56/pc.
	Technique de données						
	Aluminium	UDEP	UDEP-AMP 3		D16	1408	4,56/pc.
	Technique de données						
	Aluminium	UDEP	UDEP-AMP SL3		D16	1408	4,56/pc.





Boîtes d'appareillage et plaques de recouvrement

	type	référence	 stock	page. catal.	groupe d'articles	prix en €
	Technique de données					
Aluminium	UDEP	UDEP-GG45 3		D16	1408	4,56/pc.
	Technique de données					
Aluminium	UDEP	UDEP-LEX 2		D18	1408	4,56/pc.
	Technique de données					
Aluminium	UDEP	UDEP-KR 2		D17	1408	4,56/pc.
	Technique de données					
Aluminium	UDEP	UDEP-RM 2		D17	1408	4,56/pc.
	Technique de données					
Aluminium	UDEP	UDEP-RMSC 2		D17	1408	4,56/pc.
	Technique de données					
Aluminium	UDEP	UDEP-RMSC 3		D17	1408	4,56/pc.
	Technique de données					
Aluminium	UDEP	UDEP-KEL 3		D17	1408	10,86/pc.
	Technique de données					
Aluminium	UDEP	UDEP-SYS 2		D17	1408	4,56/pc.

Boîtes d'appareillage et plaques de recouvrement

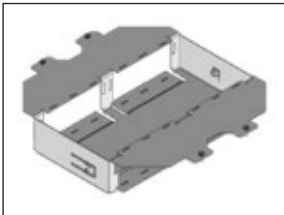
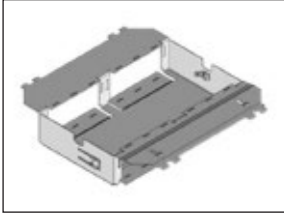
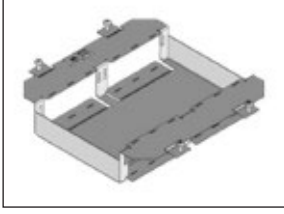
	type	référence	stock	page. catal.	groupe d'articles	prix en €
	Platine aveugle					
Aluminium	UDEP	UDEP-B		D14	1408	4,56/pc.
	Technique de connexion					
Aluminium	UDEP	UDEP-5PK 1		D19	1408	4,56/pc.
	Technique de connexion					
Aluminium	UDEP	UDEP-5PCOM 1		D19	1408	4,56/pc.
	Technique de connexion					
Aluminium	UDEP	UDEP-3PK 2		D19	1408	4,56/pc.
	Technique audio et vidéo					
Aluminium	UDEP	UDEP-KM 1		D15	1408	5,21/pc.
	Technique audio et vidéo					
Aluminium	UDEP	UDEP-XLR 2		D15	1408	4,82/pc.
	Technique audio et vidéo					
Aluminium	UDEP	UDEP-DSUB9 1		D15	1408	4,82/pc.

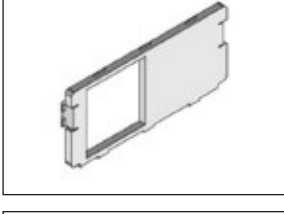
Boîtes d'appareillage et plaques de recouvrement

	type	référence	 stock	page. catal.	groupe d'articles	prix en €
Cadre d'appareillage pour cassette de nivellement ronde						
	Acier galvanisé Sendzimir	UGE	UGE3-RE 4		D27 1408	52,88/pc.
Cadre d'appareillage pour unité de nivellement UNE						
	Acier galvanisé Sendzimir	UGE	UGE3-VE 4	✓	D27 1408	52,88/pc.
Cadre d'appareillage pour boîte de sol en matière synthétique, sortie avec brosse						
	Acier galvanisé Sendzimir	UGE	UGE3-VRK 4	✓	D27 1408	52,88/pc.
Modules 45x45						
	ABS	UGEE	UGEE-2-UST-S	✓	D27 1408	6,11/pc.
Modules 45x45						
	ABS	UGE	UGEE-1-UST-S	✓	D27 1408	6,11/pc.
Pour une platine UDEP						
	ABS	UGE	UGEE-1-DEP-S		D27	6,11/pc.

BODO surélevé et mécanismes

	type	référence	📦 stock	page. catal.	groupe d'articles	prix en €	
	Base pour BODO surélevé						
	Aluminium	BODO	BODO NA-L	✓	C46	1406	296,35/pc.
	BODO surélevé, vide						
	Aluminium	BODO	BODO NAT-L	✓	C46	1406	375,93/pc.
	Connecteur d'appareil, WAGO						
	Polyamide	UVS	UVS-ST-S1K		D43	1408	4,17/pc.
	Connecteur d'appareil, WIELAND						
	Polyamide	UVSWI	UVSWI-ST-S1		D45	1408	4,05/pc.
	Prise simple, broche de terre						
	Polycarbonate	blanc	UST45FR-W 1	✓	D31	1408	9,77/pc.
		rouge	UST45FR-R 1		D31	1408	10,81/pc.
		ivoire	UST45FR-CW 1		D31	1408	9,77/pc.
	Prise double, broche de terre						
	Polycarbonate	blanc	UST45FR-W 2	✓	D31	1408	16,81/pc.
		rouge	UST45FR-R 2		D31	1408	18,84/pc.
		ivoire	UST45FR-CW 2		D31	1408	16,81/pc.
	Prise triple, broche de terre						
	Polycarbonate	blanc	UST45FR-W 3	✓	D31	1408	26,76/pc.
		rouge	UST45FR-R 3		D31	1408	29,82/pc.
		ivoire	UST45FR-CW 3		D31	1408	26,76/pc.



Gaines murales et canaux d'alimentation

Avec les gaines murales et canaux d'alimentation DUCTEL, le câblage électrique et les câbles de données et de télécommunication sont guidés via le mur vers les différents postes de travail afin d'ainsi pourvoir ces postes de prises de courant et de points de raccordement multimédia rapidement accessibles.

Les canaux d'alimentation DUCTEL ne sont utilisés que pour le passage des câbles alors que les gaines murales DUCTEL offrent la possibilité d'intégrer des prises de courant (traditionnelles ou 45x45 mm).



DUCTEL est disponible en blanc (RAL 9010) laqué ou en version naturelle anodisée et, sur demande, également disponible dans les autres couleurs RAL. La partie arrière est pourvue de perforations. Le système de gaines murales et les couvercles assortis sont toujours livrés avec un feuil de protection.



La pièce d'angle DUCTEL est utilisable comme angle intérieur ou angle extérieur. La pièce d'angle glisse sur la longueur de la gaine et est disponible en blanc et en version anodisée.



Tant les prises traditionnelles que les prises du type de 45 mm peuvent être installées. Ces dernières s'encliquettent directement dans l'ouverture du couvercle, sans outils.



L'embout est fixé sur la gaine par encliquetage sans vis ni outils. Une telle installation simplifiée offre à la fois une économie de coûts, d'effort et de temps.



Le système de gaines murales DUCTEL peut être fixé directement contre la paroi ou par l'intermédiaire de supports muraux. Des parois inégales peuvent être compensées par des pièces ajustables. L'ouverture derrière les gaines murales peut être couverte d'une plaque de couverture.



Des gaines d'alimentation sont utilisées pour le guidage de câbles dans les installations sans prises de courant. Les gaines d'alimentation plus grandes sont idéales pour amener des câbles vers des gaines murales horizontales (page 193-194).



Les nouvelles pièces d'accouplement sont conçues spécialement pour le système DUCTEL et assurent un accouplement parfait de toutes les longueurs.





Le collier DUCTEL facilite le façonnage de dérivations verticales. Montage rapide et peu coûteux.

Gaines murales DUCTEL pour mécanismes avec anneau de fixation

TB1010 PK1010	TB1310 PK1310	TB1710	TB2210	TB1032-2
				

Montage	APPARENT				ENCASTRÉ
Dimensions mm	100x65x3000	135x65x3000	170x65x3000	220x65x3000	125/100x65x3000
Nombre de couvercles 80 mm	1	1	1	2	1
Version					
* aluminium anodisé	page 181	page 184	page 187	page 189	/
* aluminium blanc (RAL 9010) laqué	page 181	page 184	page 187	page 189	N page 193
* matière synthétique, blanc	N page 182	N page 185	/	/	/

Gaines murales DUCTEL pour modules 45x45

TB1040	TB1340
	

Montage	APPARENT	
Dimensions mm	100x65x3000	135x65x3000
Nombre de couvercles 45 mm	1	2
Version		
* aluminium anodisé	page 183	page 186
* aluminium blanc (RAL 9010) laqué	page 183	page 186

Gaines murales DUCTEL pour modules 45x45 + mécanismes avec anneau de fixation





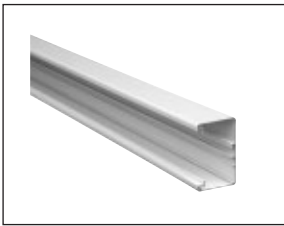
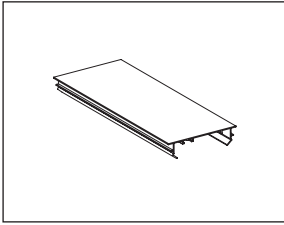
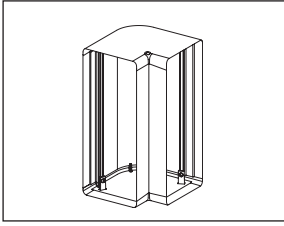
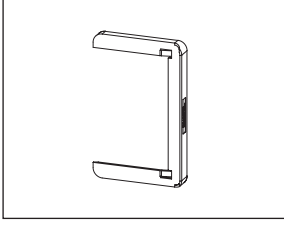
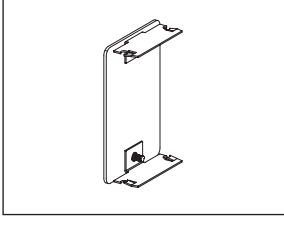
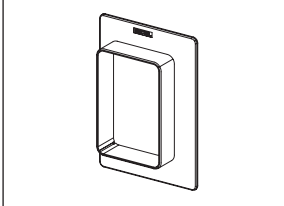

TB1740	TB2240
	

Montage	APPARENT	
Dimensions mm	170x65x3000	220x65x3000
Nombre de couvercles 45/80 mm	1x45 1x80	2x45 1x80
Version		
* aluminium anodisé	page 188	page 190
* aluminium blanc (RAL 9010) laqué	page 188	page 190

Systeme de gaines murales Ductel

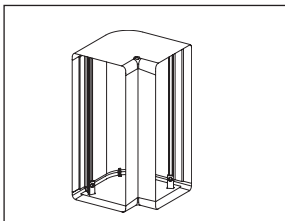
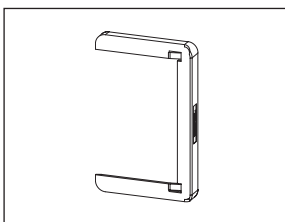
	type	référence	stock	page. catal.	groupe d'articles	prix en €	
	Base 100x65						
	Aluminium	anodisé	TB1010-1	✓	8	2601	53,15/m
	↔ 3 m	blanc laqué	TB1010-3	✓	8	2601	53,15/m
	Couvercle à commander séparément.						
	Couvercle 80x19						
	Aluminium	anodisé	TB80-1	✓	8	2601	16,71/m
	↔ 3 m	blanc laqué	TB80-3	✓	8	2601	16,71/m
	Pièce d'angle 103x90x90						
	Aluminium/matière synthétique	anodisé/gris	TBC100-1	✓	8	2601	40,87/pc.
		blanc laqué/blanc	TBC100-3	✓	8	2601	40,87/pc.
	Collier 105x67x12						
	Matière synthétique	gris	TBL10-1	✓	8	2601	8,30/pc.
		blanc	TBL10-3	✓	8	2601	8,30/pc.
	Embout 100x65x24						
	Aluminium	anodisé	TBP100-1	✓	8	2601	13,60/pc.
		blanc laqué	TBP100-3	✓	8	2601	13,60/pc.
	Plaque de finition 151x106x25						
	Matière synthétique	blanc	TB0100-3		8	2601	9,11/pc.

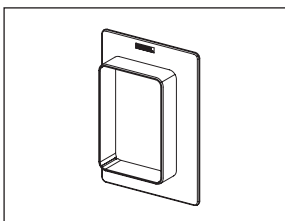
Système de gaines murales Ductel

	type	référence	📦 stock	page. catal.	groupe d'articles	prix en €
	Base 100x65					
	Matière synthétique ↔ 3 m  9 m Couvercle inclus.	blanc	PK1010-3	✓		2601
	Couverture					
	Matière synthétique	blanc	PDC100-3			2601
	Pièce d'angle 103x90x90					
	Aluminium/matière synthétique	blanc laqué/blanc	TBC100-3	✓	9	2601
	Collier 105x67x12					
	Matière synthétique	blanc	TBL10-3	✓	9	2601
	Embout 100x65x24					
	Matière synthétique	blanc	PKE100-3	✓		2601
	Plaque de finition 151x106x25					
	Matière synthétique	blanc	TB0100-3		9	2601
	Accouplement					
	Matière synthétique	blanc	PKJ1	✓		2601



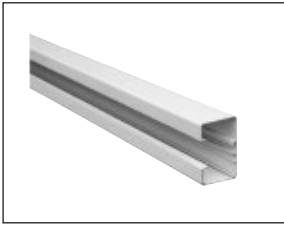
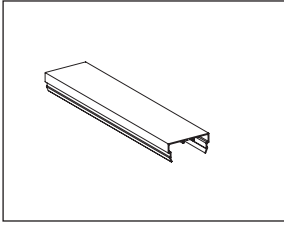
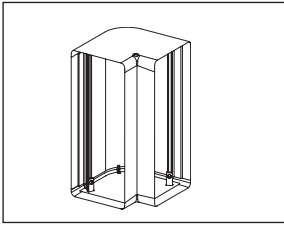
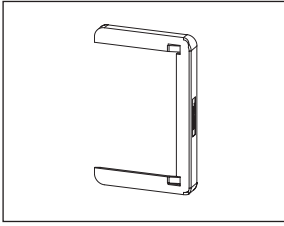
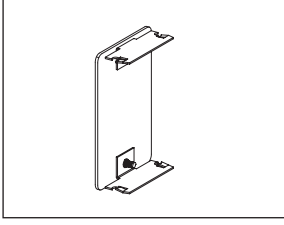
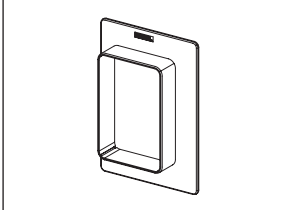

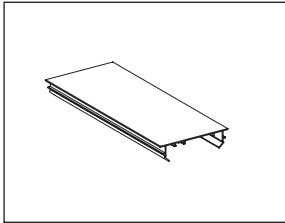
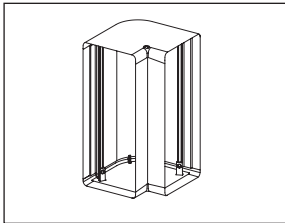
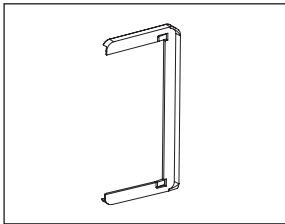
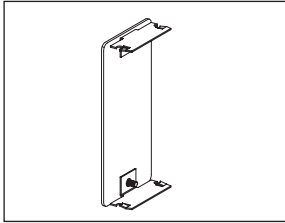
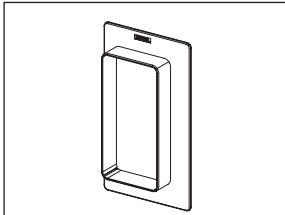

Systeme de gaines murales Ductel

	type	référence	stock	page. catal.	groupe d'articles	prix en €
	Base 100x65					
	Aluminium					
	↔ 3 m	anodisé blanc laqué	TB1040-1 TB1040-3	✓ ✓	9 9	2601 2601
	Couvercle à commander séparément.					
	Couvercle 45x19					
	Aluminium					
	↔ 3 m	anodisé blanc laqué	TB45-1 TB45-3	✓ ✓	9 9	2601 2601
	Pièce d'angle 103x90x90					
	Aluminium/matière synthétique					
		anodisé/gris blanc laqué/blanc	TBC100-1 TBC100-3	✓ ✓	9 9	2601 2601
	Collier 105x67x12					
	Matière synthétique					
		gris blanc	TBL10-1 TBL10-3	✓ ✓	9 9	2601 2601
	Embout 100x65x24					
	Aluminium					
		anodisé blanc laqué	TBP100-1 TBP100-3	✓ ✓	9 9	2601 2601
	Plaque de finition 151x106x25					
	Matière synthétique					
		blanc	TB0100-3		9	2601

Système de gaines murales Ductel

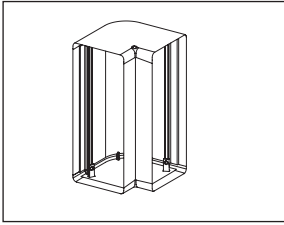
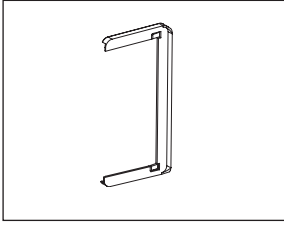
	type	référence	🌀 stock	page. catal.	groupe d'articles	prix en €
	Base 135x65					
	Aluminium					
	↔ 3 m	anodisé blanc laqué	TB1310-1 TB1310-3	✓ ✓	10 10	2601 2601
	Couvercle à commander séparément.					
	Couvercle 80x19					
	Aluminium					
	↔ 3 m	anodisé blanc laqué	TB80-1 TB80-3	✓ ✓	10 10	2601 2601
	Pièce d'angle 138x90x90					
	Aluminium/matière synthétique					
		anodisé/gris blanc laqué/blanc	TBC135-1 TBC135-3	✓ ✓	10 10	2601 2601
	Collier 140x67x12					
	Matière synthétique					
		gris blanc	TBL13-1 TBL13-3	✓ ✓	10 10	2601 2601
	Embout 135x65x24					
	Aluminium					
		anodisé blanc laqué	TBP135-1 TBP135-3	✓ ✓	10 10	2601 2601
	Plaque de finition 186x106x25					
	Matière synthétique					
		blanc	TB0135-3	✓	10	2601

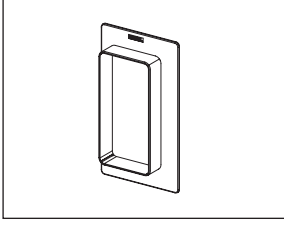
Système de gaines murales Ductel

	type	référence	stock	page. catal.	groupe d'articles	prix en €
	Base 135x65					
	Matière synthétique ↔ 3 m  9 m Couverture inclus.	blanc	PK1310-3		2601	33,93/m
	Couverture					
	Matière synthétique	blanc	PDC135-3		2601	5,03/pc.
	Pièce d'angle 138x90x90					
	Aluminium/matière synthétique	blanc laqué/blanc	TBC135-3	✓	10 2601	40,87/pc.
	Collier 140x67x12					
	Matière synthétique	blanc	TBL13-3	✓	10 2601	8,30/pc.
	Embout 135x65x24					
	Matière synthétique	blanc	PKE135-3		2601	5,71/pc.
	Plaque de finition 186x106x25					
	Matière synthétique	blanc	TB0135-3	✓	10 2601	9,68/pc.
	Accouplement					
	Matière synthétique	blanc	PKJ1	✓	2601	1,89/pc.

Systeme de gaines murales Ductel

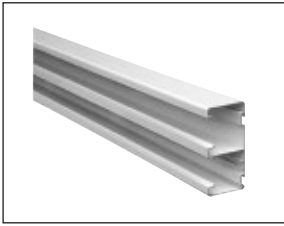
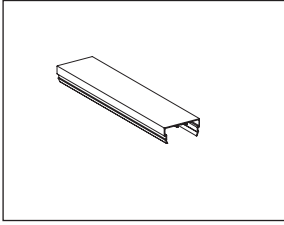
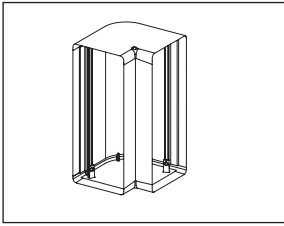
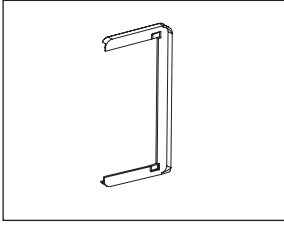
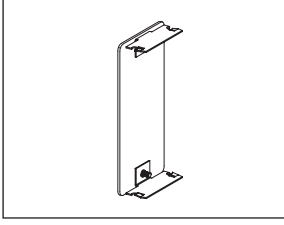
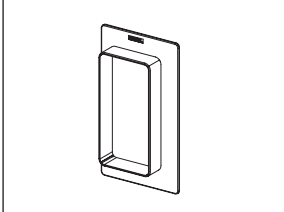
	type	référence	stock	page. catal.	groupe d'articles	prix en €
	Base 135x65					
	Aluminium					
	↔ 3 m	anodisé blanc laqué	TB1340-1 TB1340-3	✓ ✓	11 11	2601 2601
	Couvercle à commander séparément.					
	Couvercle 45x19					
	Aluminium					
		anodisé blanc laqué	TB45-1 TB45-3	✓ ✓	11 11	2601 2601
	Pièce d'angle 138x90x90					
	Aluminium/matière synthétique					
		anodisé/gris blanc laqué/blanc	TBC135-1 TBC135-3	✓ ✓	11 11	2601 2601
	Collier 140x67x12					
	Matière synthétique					
		gris blanc	TBL13-1 TBL13-3	✓ ✓	11 11	2601 2601
	Embout 135x65x24					
	Aluminium					
		anodisé blanc laqué	TBP135-1 TBP135-3	✓ ✓	11 11	2601 2601
	Plaque de finition 186x106x25					
	Matière synthétique					
		blanc	TB0135-3	✓	11	2601

Systeme de gaines murales Ductel

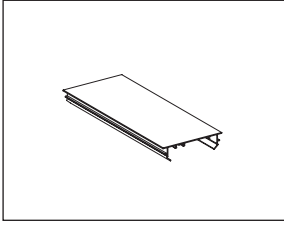
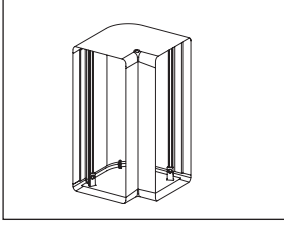
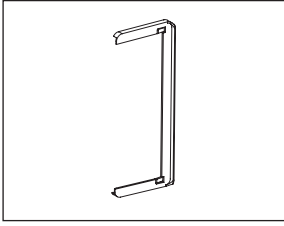
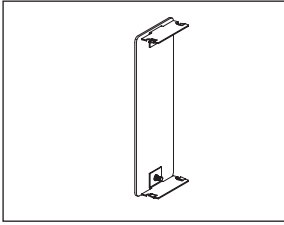
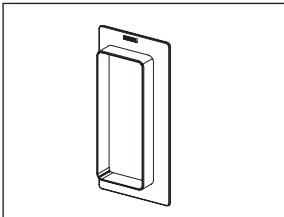
	type	référence	stock	page. catal.	groupe d'articles	prix en €	
	Base 170x65						
	Aluminium	anodisé	TB1710-1	✓	12	2601	69,57/m
	↔ 3 m	blanc laqué	TB1710-3	✓	12	2601	69,57/m
	Couvercle à commander séparément.						
	Couvercle 80x19						
	Aluminium	anodisé	TB80-1	✓	12	2601	16,71/m
	↔ 3 m	blanc laqué	TB80-3	✓	12	2601	16,71/m
	Pièce d'angle 173x90x90						
	Aluminium/matière synthétique	anodisé/gris	TBC170-1	✓	12	2601	43,34/pc.
		blanc laqué/blanc	TBC170-3	✓	12	2601	43,34/pc.
	Collier 175x67x12						
	Matière synthétique	gris	TBL17-1	✓	12	2601	8,30/pc.
		blanc	TBL17-3	✓	12	2601	8,30/pc.
	Embout 170x65x24						
	Aluminium	anodisé	TBP170-1	✓	12	2601	16,49/pc.
		blanc laqué	TBP170-3	✓	12	2601	16,49/pc.
	Plaque de finition 221x106x25						
	Matière synthétique	blanc	TB0170-3	✓	12	2601	9,98/pc.

Systeme de gaines murales Ductel

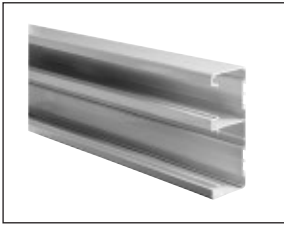
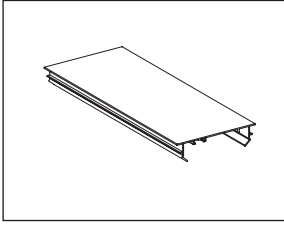
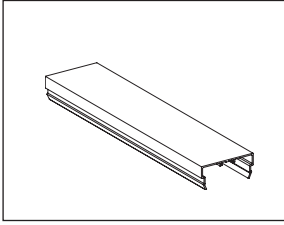
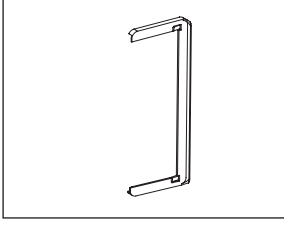
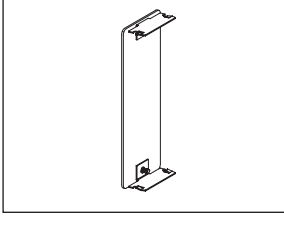
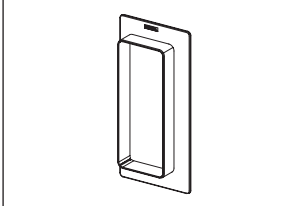
	type	référence	stock	page. catal.	groupe d'articles	prix en €
	Base 170x65					
	Aluminium					
	↔ 3 m	anodisé blanc laqué	TB1740-1 TB1740-3	✓ ✓	13 13	2601 2601
	Couvercle à commander séparément.					
	Couvercle 80x19					
	Aluminium					
	↔ 3 m	anodisé blanc laqué	TB80-1 TB80-3	✓ ✓	13 13	2601 2601
	Couvercle 45x19					
	Aluminium					
	↔ 3 m	anodisé blanc laqué	TB45-1 TB45-3	✓ ✓	13 13	2601 2601
	Pièce d'angle 173x90x90					
	Aluminium/matière synthétique					
		anodisé/gris blanc laqué/blanc	TBC170-1 TBC170-3	✓ ✓	13 13	2601 2601
	Collier 175x67x12					
	Matière synthétique					
		gris blanc	TBL17-1 TBL17-3	✓ ✓	13 13	2601 2601
	Embout 170x65x24					
	Aluminium					
		anodisé blanc laqué	TBP170-1 TBP170-3	✓ ✓	13 13	2601 2601
	Plaque de finition 221x106x25					
	Matière synthétique					
		blanc	TB0170-3	✓	13	2601



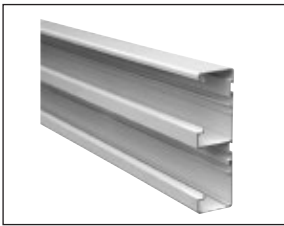
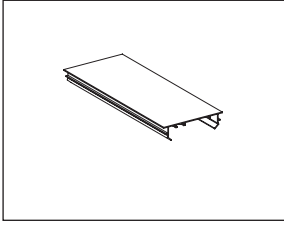
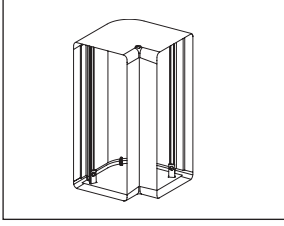
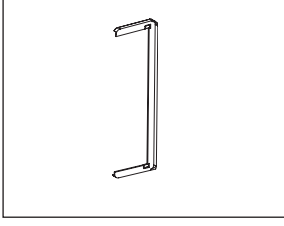
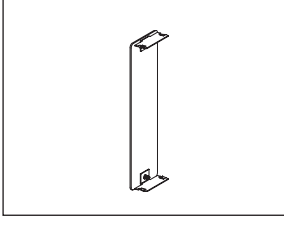
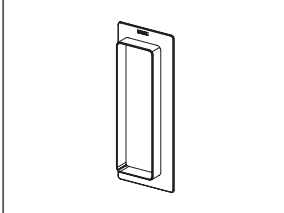



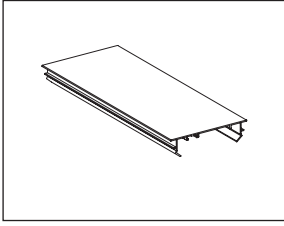
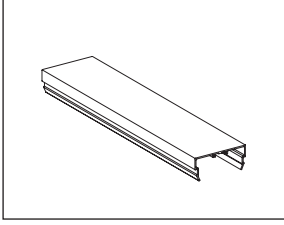
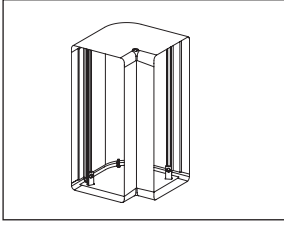
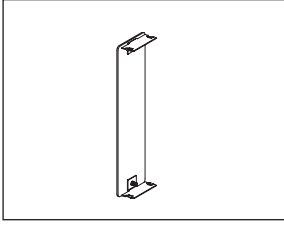



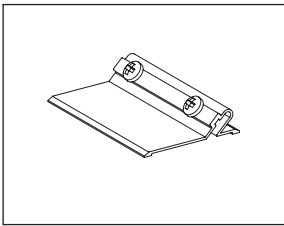

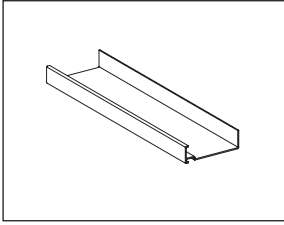
Systeme de gaines murales Ductel

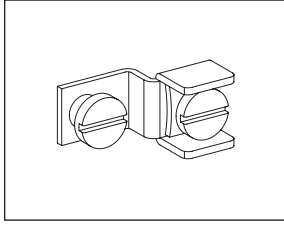
	type	référence	stock	page. catal.	groupe d'articles	prix en €	
	Base 220x65						
	Aluminium	anodisé	TB2210-1	✓	14	2601	93,84/m
	↔ 3 m	blanc laqué	TB2210-3	✓	14	2601	93,84/m
	Couvercle à commander séparément.						
	Couvercle 80x19						
	Aluminium	anodisé	TB80-1	✓	14	2601	16,71/m
	↔ 3 m	blanc laqué	TB80-3	✓	14	2601	16,71/m
	Pièce d'angle 223x90x90						
	Aluminium/matière synthétique	anodisé/gris	TBC220-1		14	2601	45,93/pc.
		blanc laqué/blanc	TBC220-3		14	2601	45,93/pc.
	Collier 225x67x12						
	Matière synthétique	gris	TBL22-1		14	2601	8,30/pc.
		blanc	TBL22-3		14	2601	8,30/pc.
	Embout 220x65x24						
	Aluminium	anodisé	TBP220-1	✓	14	2601	18,16/pc.
		blanc laqué	TBP220-3		14	2601	18,16/pc.
	Plaque de finition 271x106x25						
	Matière synthétique	blanc	TB0220-3		14	2601	10,38/pc.

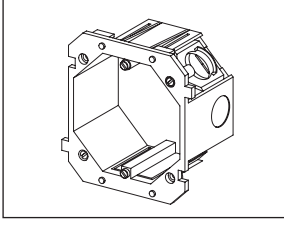

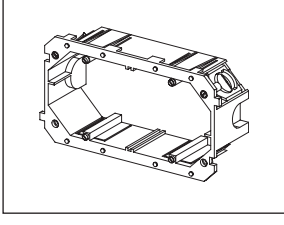

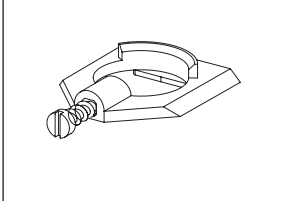





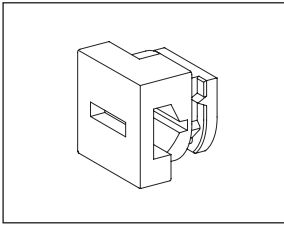

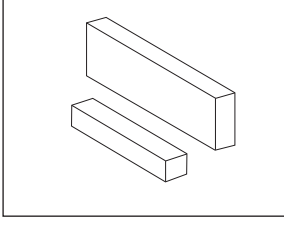
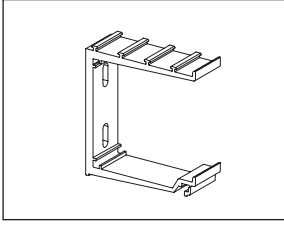
Systeme de gaines murales Ductel

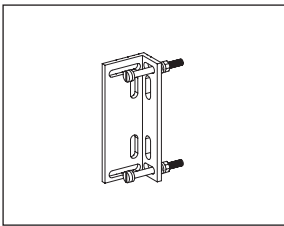
	type	référence	🌀 stock	page. catal.	groupe d'articles	prix en €
	Base 220x65					
	Aluminium					
	↔ 3 m	anodisé blanc laqué			2601 2601	116,77/m 116,77/m
	Couvercle à commander séparément.					
	Couvercle 80x19					
	Aluminium					
	↔ 3 m	anodisé blanc laqué	✓ ✓		2601 2601	16,71/m 16,71/m
	Couvercle 45x19					
	Aluminium					
	↔ 3 m	anodisé blanc laqué	✓ ✓		2601 2601	11,93/m 11,93/m
	Pièce d'angle 223x90x90					
	Aluminium/matière synthétique					
		anodisé/gris blanc laqué/blanc			2601 2601	45,93/pc. 45,93/pc.
	Collier 225x67x12					
	Matière synthétique					
		gris blanc			2601 2601	8,30/pc. 8,30/pc.
	Embout 220x65x24					
	Aluminium					
		anodisé blanc laqué	✓		2601 2601	18,16/pc. 18,16/pc.
	Plaque de finition 271x106x25					
	Matière synthétique					
		blanc			2601	10,38/pc.

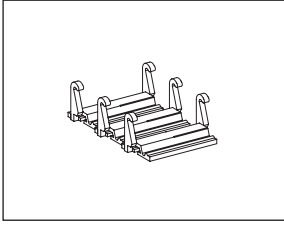
Systeme de gaines murales Ductel

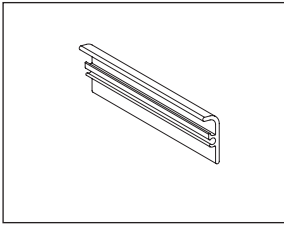
	type	référence	stock	page. catal.	groupe d'articles	prix en €
	Accouplement 12x53x70					
	Aluminium  20 pc. Uniquement pour gaines murales en aluminium.	TBJ1	✓	15	2601	4,73/pc.
	Cloison de séparation 15x52					
	Aluminium  1 m	TDH1	✓	15	2601	11,52/m
	Borne de mise à la terre					
	Acier  20 pc.	TBM1	✓	16	2601	7,19/pc.
	Boîte d'encastrement 79x42,5x79					
	Matière synthétique bleu  10 pc.	TBF1	✓	17	2601	6,23/pc.
	Boîte d'encastrement 79x42,5x150					
	Matière synthétique bleu  5 pc.	TBF2	✓	17	2601	14,12/pc.
	Serre-câbles					
	Matière synthétique noir  20 pc.	TBF11		17	2601	1,44/pc.

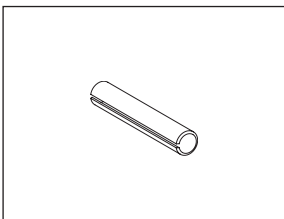
Systeme de gaines murales Ductel

	type	référence	stock	page. catal.	groupe d'articles	prix en €
	Clame de fixation					
	Matière synthétique  100 pc.	TBK1		16	2601	1,55/pc.
	Bande d'isolation					
	Matière synthétique	32x30x300	XTB0304	16	2601	9,46/pc.
		74x30x300	XTB0308	16	2601	16,26/pc.
	Etrier mural					
	Aluminium					
	 20 pc.	25	TBE25	15	2601	6,74/pc.
		50	TBE50	15	2601	8,07/pc.
		75	TBE75	15	2601	10,38/pc.
		100	TBE100	15	2601	12,84/pc.
		125	TBE125	15	2601	15,63/pc.
	Plaque d'ajustage					
	Aluminium  20 pc.		TBE1	15	2601	10,26/pc.
	Clip de fixation pour ailettes de ventilation 73x40					
	Matière synthétique  20 pc.		TBE3	16	2601	3,34/pc.
	Ailettes de ventilation 24x9					
	Aluminium					
		anodisé	TBE20-1	17	2601	11,25/m
	 3 m  90 m	blanc laqué	TBE20-3	17	2601	11,25/m
	Accouplement 3x18					
	Acier  10 pc.		TBJ8	17	2601	0,51/pc.

Gaine murale encastrée et canaux d'alimentation Ductel

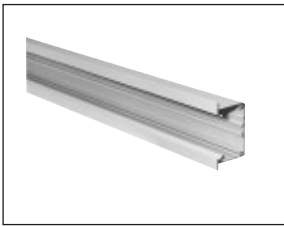
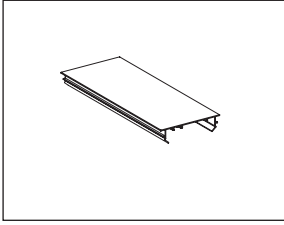
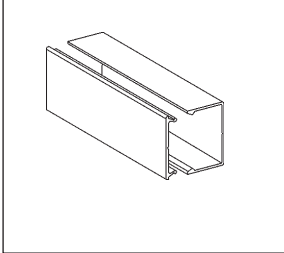
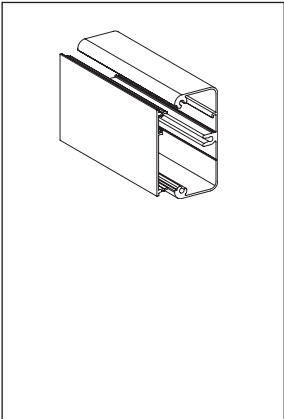
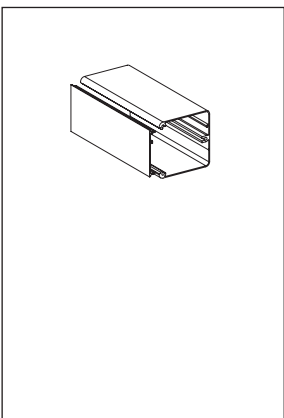
	type	référence	📦 stock	page. catal.	groupe d'articles	prix en €
	Base 125/100x65					
	Aluminium ↔ 3 m	blanc laqué TB1032-3	✓		2601	60,62/m
	Couvercle à commander séparément.					
	Couvercle 80x19					
	Aluminium ↔ 3 m	blanc laqué TB80-3	✓		2601	16,71/m
	Base 30x20,5					
	Aluminium ↔ 3 m	anodisé TBA202-1	✓		2602	17,06/m
		blanc laqué TBA202-3	✓		2602	17,06/m
	Couvercle 32x6					
Aluminium ↔ 3 m	anodisé TBA22-1	✓		2602	11,52/m	
	blanc laqué TBA22-3	✓		2602	11,52/m	
	Base 65x30					
	Aluminium ↔ 3 m	anodisé TBA302-1		21	2602	32,17/m
		blanc laqué TBA302-3	✓	21	2602	32,17/m
	Couvercle 54x7,5					
Aluminium ↔ 3 m	anodisé TBA32-1		21	2602	12,11/m	
	blanc laqué TBA32-3	✓	21	2602	12,11/m	
Embout 65x30						
Aluminium	anodisé TBD30-1		21	2602	10,43/pc.	
	blanc laqué TBD30-3	✓	21	2602	10,43/pc.	
	Base 65x65					
	Aluminium ↔ 3 m	anodisé TBA652-1		21	2602	42,13/m
		blanc laqué TBA652-3		21	2602	42,13/m
	Couvercle 54x7,5					
Aluminium ↔ 3 m	anodisé TBA32-1		21	2602	12,11/m	
	blanc laqué TBA32-3	✓	21	2602	12,11/m	
Embout 65x65						
Aluminium	anodisé TBD65-1		21	2602	10,55/pc.	
	blanc laqué TBD65-3		21	2602	10,55/pc.	

Gaines d'alimentation Ductel

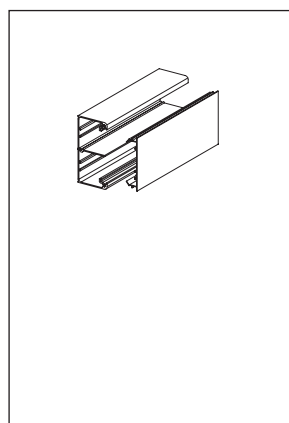

Base 100x49

Aluminium	type	référence	stock	page. catal.	groupe d'articles	prix en €
↔ 3 m	anodisé	TBA10-1		21	2602	59,36/m
	blanc laqué	TBA10-3		21	2602	59,36/m

Couvercle 80x19

Aluminium	type	référence	stock	page. catal.	groupe d'articles	prix en €
↔ 3 m	anodisé	TB80-1	✓	21	2601	16,71/m
	blanc laqué	TB80-3	✓	21	2601	16,71/m

Embout 100x49

Aluminium	type	référence	stock	page. catal.	groupe d'articles	prix en €
	anodisé	TBD100-1		21	2602	11,76/pc.
	blanc laqué	TBD100-3		21	2602	11,76/pc.

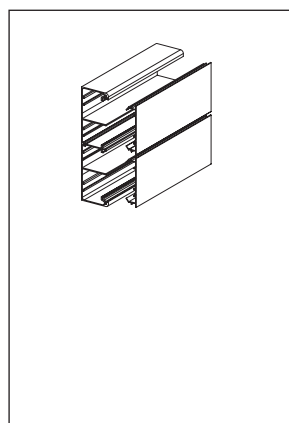

Base 184x49

Aluminium	type	référence	stock	page. catal.	groupe d'articles	prix en €
↔ 3 m	anodisé	TBA18-1		21	2602	104,61/m
	blanc laqué	TBA18-3		21	2602	104,61/m

Couvercle 80x19

Aluminium	type	référence	stock	page. catal.	groupe d'articles	prix en €
↔ 3 m	anodisé	TB80-1	✓	21	2601	16,71/m
	blanc laqué	TB80-3	✓	21	2601	16,71/m

Embout 184x49

Aluminium	type	référence	stock	page. catal.	groupe d'articles	prix en €
	anodisé	TBD180-1		21	2602	13,32/pc.
	blanc laqué	TBD180-3		21	2602	13,32/pc.



Canalisations à câbles en matière synthétique

Les gaines murales et canaux d'alimentation en matière synthétique conduisent le câblage de courant, de données et de télécommunication via la paroi vers les différents endroits afin de les pourvoir simplement de prises de courant et de points de connexion multimédia à accès aisé.

Canaux d'alimentation

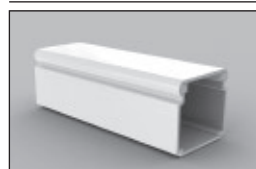

avec encoche
page 216

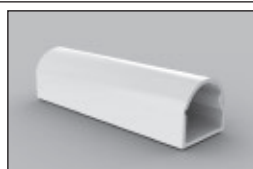

avec couvercle à charnière
page 214



anguleux
page 217-220



élégant
sur demande

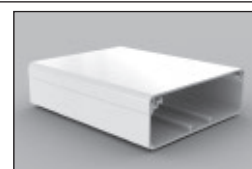

canal d'alimentation
page 220-221

Canaux de sol – Canaux de coin – Canaux de plinthe



canal de sol arrondi
page 215

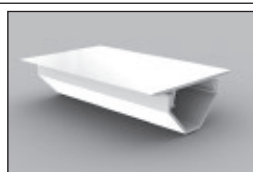

canal de coin
triangulaire page 214

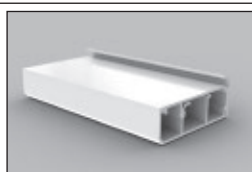

canal de plinthe
page 212

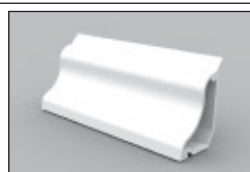

canal de plinthe
page 211

Gainés murales

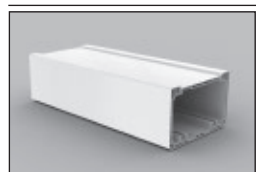

pour montage à
anneau standard
page 200-203



pour modules 45 x 45
page 197-199

Goulottes de câblage



goulotte de câblage
page 222



Canalisations à câbles en matière synthétique exemptes d'halogènes

La version des gaines murales et canaux d'alimentation exempts d'halogènes est requise dans les bâtiments publics comme les hôpitaux, les écoles, les musées, les centres d'aide sociale, ...

Grâce à leur composition chimique spécifique, les gaines à câbles exemptes d'halogènes KOPOS émettent, en cas d'incendie, moins de gaz nuisibles, qui – en combinaison avec des produits extincteurs – peuvent produire des gaz toxiques. Donc, en cas d'incendie, la sécurité des personnes encore présentes dans le bâtiment et des services d'urgence est considérablement augmentée. Ainsi, les blessures corporelles et les dommages peuvent être limités au minimum.

Canaux d'alimentation type LHD – exempts d'halogènes

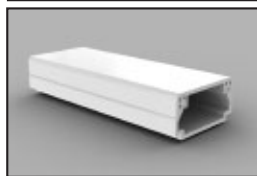

LHD20x10HF
page 217

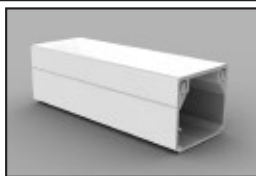

LHD20x20HF
page 218

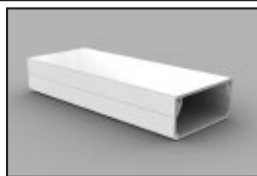

LHD40x20HF
page 219

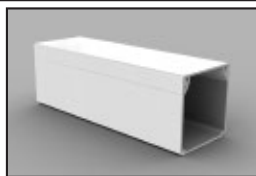

LHD40x40HF
page 220



EKD80x40HF
page 221

Canal d'alimentation EKD exempt d'halogènes

Gainés murales – exemptes d'halogènes

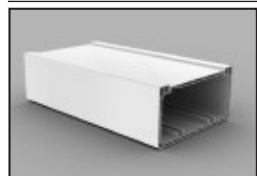

PK110x70DHF
pour montage à
anneau standard
page 201

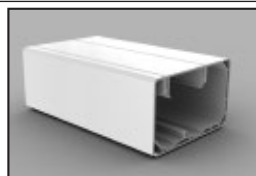





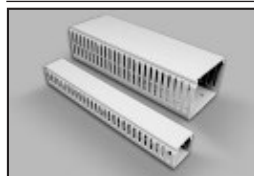





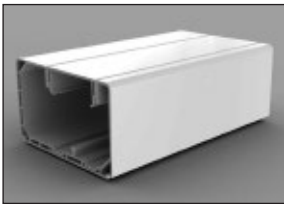



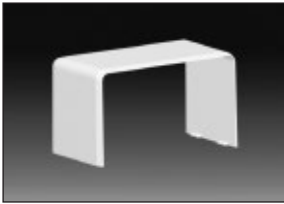

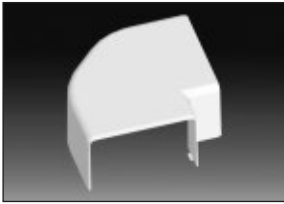
PK90x55DHF
pour modules 45 x 45
page 197

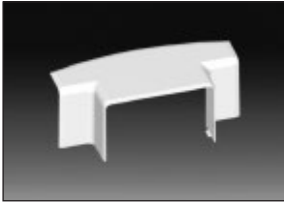
Goulottes de câblage – exemptes d'halogènes











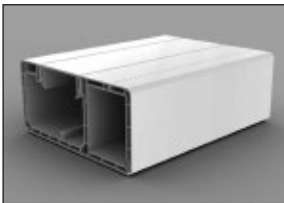



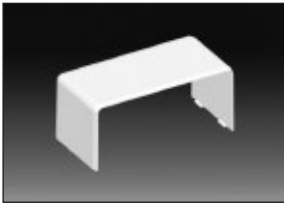



RK...X...HF
page 222











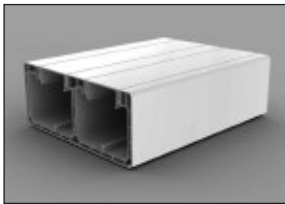



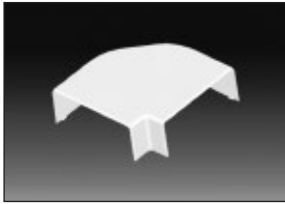

Systemes de gaines murales PK

	type	référence	stock	page. catal.	groupe d'articles	prix en €	
	Base + couvercle PK 90x55 D						
	Matière synthétique	blanc	KPK90X55DHD	✓	43	2501	16,39/m
	Matière synthétique exempte d'halogènes	blanc	KPK90X55DHFHD	✓	55	2501	44,25/m
	↔ 2 m  12 m						
	Embout PK 90x55 D						
	Matière synthétique	blanc	K8401HB	✓	43	2506	7,56/pc.
	Matière synthétique exempte d'halogènes	blanc	K8401HFHB	✓	55	2506	10,58/pc.
	 2 pc.						
	Accouplement PK 90x55 D						
	Matière synthétique	blanc	K8402HB	✓	43	2506	7,56/pc.
	Matière synthétique exempte d'halogènes	blanc	K8402HFHB	✓	55	2506	10,58/pc.
	 2 pc.						
	Angle plat PK 90x55 D						
	Matière synthétique	blanc	K8403HB	✓	43	2506	15,09/pc.
	Matière synthétique exempte d'halogènes	blanc	K8403HFHB	✓	55	2506	18,61/pc.
	 2 pc.						
	Pièce en T PK 90x55 D						
	Matière synthétique	blanc	K8404HB	✓	43	2506	15,09/pc.
	Matière synthétique exempte d'halogènes	blanc	K8404HFHB	✓	55	2506	18,61/pc.
	 2 pc.						
	Angle intérieur PK 90x55 D						
	Matière synthétique	blanc	K8405HB	✓	43	2506	15,09/pc.
	Matière synthétique exempte d'halogènes	blanc	K8405HFHB	✓	55	2506	18,61/pc.
	 2 pc.						
	Angle extérieur PK 90x55 D						
	Matière synthétique	blanc	K8406HB	✓	43	2506	15,09/pc.
	Matière synthétique exempte d'halogènes	blanc	K8406HFHB	✓	55	2506	18,61/pc.
	 2 pc.						
	Plaque de finition PK 90x55 D						
	Matière synthétique	blanc	K8407HB	✓	43	2506	5,95/pc.
	Matière synthétique exempte d'halogènes	blanc	K8407HFHB	✓	55	2506	10,58/pc.
	 2 pc.						











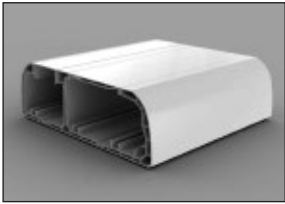

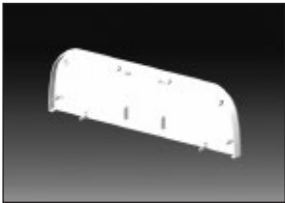

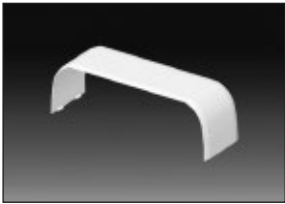

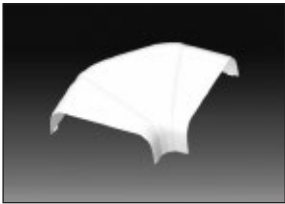
Systemes de gaines murales PK

	type	référence	 stock	page. catal.	groupe d'articles	prix en €
	Base + couvercle PK 120x55 D					
Matière synthétique	blanc	KPK120X55DHD	44	2501	28,34/m	
↔ 2 m  6 m						
	Embout PK 120x55 D					
Matière synthétique	blanc	K8471HB	44	2506	11,76/pc.	
 2 pc.						
	Accouplement PK 120x55 D					
Matière synthétique	blanc	K8472HB	44	2506	11,76/pc.	
 2 pc.						
	Angle plat PK 120x55 D					
Matière synthétique	blanc	K8473HB	44	2506	20,70/pc.	
 2 pc.						
	Pièce en T PK 120x55 D					
Matière synthétique	blanc	K8474HB	44	2506	20,70/pc.	
 2 pc.						
	Angle intérieur PK 120x55 D					
Matière synthétique	blanc	K8475HB	44	2506	20,70/pc.	
 2 pc.						
	Angle extérieur PK 120x55 D					
Matière synthétique	blanc	K8476HB	44	2506	20,70/pc.	
 2 pc.						
	Plaque de finition PK 120x55 D					
Matière synthétique	blanc	K8477HB	44	2506	8,23/pc.	
 2 pc.						











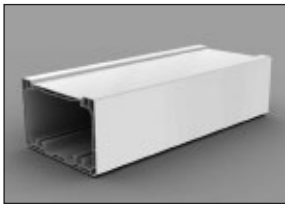

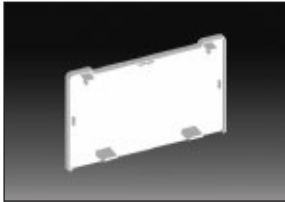

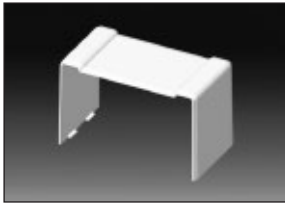

Systemes de gaines murales PK

	type	référence	stock	page. catal.	groupe d'articles	prix en €
	Base + couvercle PK 160x65 D					
	Matière synthétique ↔ 2 m  6 m	blanc	KPK160X65DHD	✓	45	2501
	Embout PK 160x65 D					
	Matière synthétique  2 pc.	blanc	K8481HB	✓	45	2506
	Accouplement PK 160x65 D					
	Matière synthétique  2 pc.	blanc	K8482HB	✓	45	2506
	Angle plat PK 160x65 D					
	Matière synthétique  2 pc.	blanc	K8483HB	✓	45	2506
	Pièce en T PK 160x65 D					
	Matière synthétique  2 pc.	blanc	K8484HB	✓	45	2506
	Angle intérieur PK 160x65 D					
	Matière synthétique  2 pc.	blanc	K8485HB	✓	45	2506
	Angle extérieur PK 160x65 D					
	Matière synthétique  2 pc.	blanc	K8486HB	✓	45	2506
	Plaque de finition PK 160x65 D					
	Matière synthétique  2 pc.	blanc	K8487HB	✓	45	2506











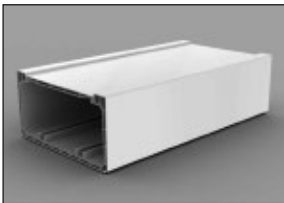

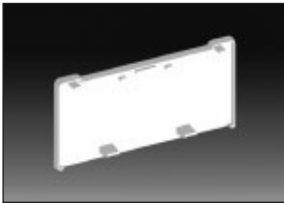

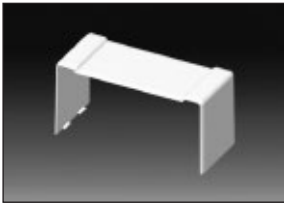

Systemes de gaines murales PK

	type	référence	 stock	page. catal.	groupe d'articles	prix en €
	Base + couvercle PK 210x70 D					
Matière synthétique	blanc	KPK210X70DHD		46	2501	50,55/m
↔ 2 m  6 m						
	Embout PK 210x70 D					
Matière synthétique	blanc	K8491HB		46	2506	17,43/pc.
 2 pc.						
	Accouplement PK 210x70 D					
Matière synthétique	blanc	K8492HB		46	2506	17,65/pc.
 2 pc.						
	Angle plat PK 210x70 D					
Matière synthétique	blanc	K8493HB		46	2506	27,77/pc.
 2 pc.						
	Pièce en T PK 210x70 D					
Matière synthétique	blanc	K8494HB		46	2506	27,77/pc.
 2 pc.						
	Angle intérieur PK 210x70 D					
Matière synthétique	blanc	K8495HB		46	2506	27,77/pc.
 2 pc.						
	Angle extérieur PK 210x70 D					
Matière synthétique	blanc	K8496HB		46	2506	27,77/pc.
 2 pc.						
	Plaque de finition PK 210x70 D					
Matière synthétique	blanc	K8497HB		46	2506	12,48/pc.
 2 pc.						











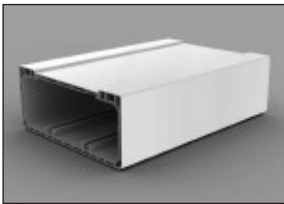

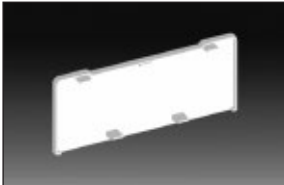

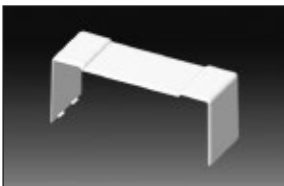

Systemes de gaines murales PK

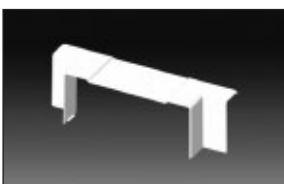
	type	référence	stock	page. catal.	groupe d'articles	prix en €	
	Base + couvercle PK 110x70 D						
	Matière synthétique	blanc	KPK110X70DHD	✓	40	2501	24,03/m
	Matière synthétique exempte d'halogènes	blanc	KPK110X70DHFHD	✓	54	2501	65,22/m
	↔ 2 m  6 m						
	Embout PK 110x70 D						
	Matière synthétique	blanc	K8451HB	✓	40	2506	10,60/pc.
	Matière synthétique exempte d'halogènes	blanc	K8451HFHB	✓	54	2506	12,59/pc.
	 2 pc.						
	Accouplement PK 110x70 D						
	Matière synthétique	blanc	K8452HB	✓	40	2506	9,88/pc.
	Matière synthétique exempte d'halogènes	blanc	K8452HFHB	✓	54	2506	12,01/pc.
	 2 pc.						
	Angle plat PK 110x70 D						
	Matière synthétique	blanc	K8453HB	✓	40	2506	16,23/pc.
	Matière synthétique exempte d'halogènes	blanc	K8453HFHB	✓	54	2506	18,32/pc.
	 2 pc.						
	Pièce en T PK 110x70 D						
	Matière synthétique	blanc	K8454HB	✓	40	2506	16,23/pc.
	Matière synthétique exempte d'halogènes	blanc	K8454HFHB	✓	54	2506	18,32/pc.
	 2 pc.						
	Angle intérieur PK 110x70 D						
	Matière synthétique	blanc	K8455HB	✓	40	2506	17,17/pc.
	Matière synthétique exempte d'halogènes	blanc	K8455HFHB	✓	54	2506	19,36/pc.
	 2 pc.						
	Angle extérieur PK 110x70 D						
	Matière synthétique	blanc	K8456HB	✓	40	2506	16,23/pc.
	Matière synthétique exempte d'halogènes	blanc	K8456HFHB	✓	54	2506	18,32/pc.
	 2 pc.						
	Plaque de finition PK 110x70 D						
	Matière synthétique	blanc	K8457HB	✓	40	2506	5,89/pc.
	Matière synthétique exempte d'halogènes	blanc	K8457HFHB	✓	54	2506	7,31/pc.
	 2 pc.						











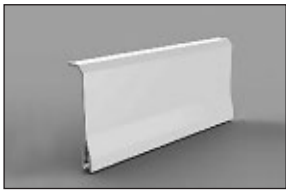

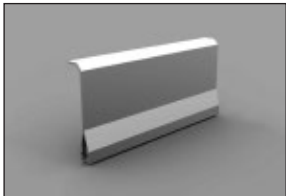

Systemes de gaines murales PK

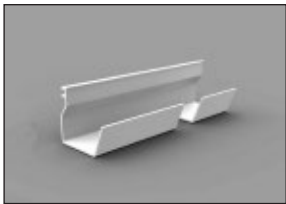
	type	référence	 stock	page. catal.	groupe d'articles	prix en €
	Base + couvercle PK 140x70 D					
	Matière synthétique					
	↔ 2 m  6 m	blanc	KPK140X70DHD	41	2501	29,14/m
	Embout PK 140x70 D					
	Matière synthétique					
	 2 pc.	blanc	K8461HB	41	2506	12,00/pc.
	Accouplement PK 140x70 D					
	Matière synthétique					
	 2 pc.	blanc	K8462HB	41	2506	12,00/pc.
	Angle plat PK 140x70 D					
	Matière synthétique					
	 2 pc.	blanc	K8463HB	41	2506	19,29/pc.
	Pièce en T PK 140x70 D					
	Matière synthétique					
	 2 pc.	blanc	K8464HB	41	2506	19,29/pc.
	Angle intérieur PK 140x70 D					
	Matière synthétique					
	 2 pc.	blanc	K8465HB	41	2506	19,29/pc.
	Angle extérieur PK 140x70 D					
	Matière synthétique					
	 2 pc.	blanc	K8466HB	41	2506	19,29/pc.
	Plaque de finition PK 140x70 D					
	Matière synthétique					
	 2 pc.	blanc	K8467HB	41	2506	6,83/pc.

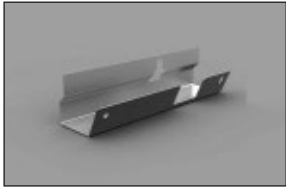

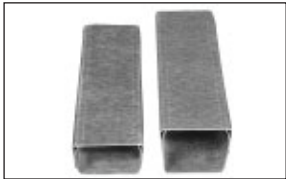









Systemes de gaines murales PK

	type	référence	 stock	page. catal.	groupe d'articles	prix en €
						
Base + couvercle PK 170x70 D						
Matière synthétique	blanc	KPK170X70DHD		42	2501	35,35/m
↔ 2 m  6 m						
						
Embout PK 170x70 D						
Matière synthétique	blanc	K8441HB		42	2506	16,01/pc.
 2 pc.						
						
Accouplement PK 170x70 D						
Matière synthétique	blanc	K8442HB		42	2506	16,01/pc.
 2 pc.						
						
Angle plat PK 170x70 D						
Matière synthétique	blanc	K8443HB		42	2506	20,99/pc.
 2 pc.						
						
Pièce en T PK 170x70 D						
Matière synthétique	blanc	K8444HB		42	2506	20,99/pc.
 2 pc.						
						
Angle intérieur PK 170x70 D						
Matière synthétique	blanc	K8445HB		42	2506	20,99/pc.
 2 pc.						
						
Angle extérieur PK 170x70 D						
Matière synthétique	blanc	K8446HB		42	2506	20,99/pc.
 2 pc.						
						
Plaque de finition PK 170x70 D						
Matière synthétique	blanc	K8447HB		42	2506	9,14/pc.
 2 pc.						



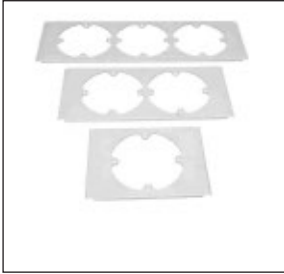







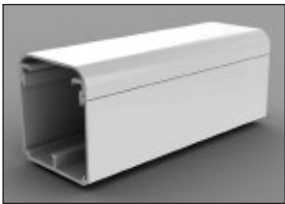

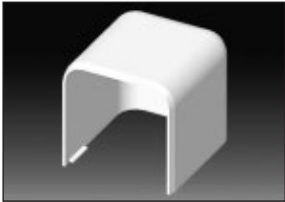

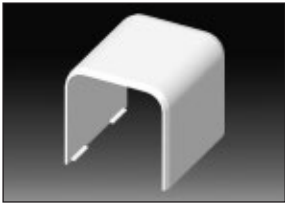
Systemes de gaines murales PK

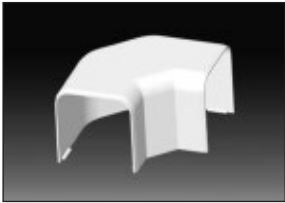
	type	référence	📦 stock	page. catal.	groupe d'articles	prix en €
	Cloison de séparation H= 45 mm					
	Matière synthétique					
	blanc	KPEKE60C	✓	57	2501	6,35/m
	↔ 2 m  20 m					
	Cloison de séparation H= 45 mm					
	Matière synthétique avec feuil métallique	KPKS70/60		57	2501	10,34/m
	↔ 2 m  20 m					
	Cloison de séparation H= 29,5 mm					
	Matière synthétique	blanc		57	2503	2,94/m
	Matière synthétique exempte d'halogènes	blanc	✓	56	2503	7,53/m
	↔ 2 m  20 m					
	Cloison de séparation H= 42,5 mm					
	Matière synthétique	blanc		58	2501	12,54/m
	↔ 2 m  32 m	KPEP60HD				
	Cloison de séparation H= 42,5 mm					
	Acier			58	2501	29,40/m
	↔ 2 m  24 m	KPEP60/KS				
	Canal de blindage pour gaines murales PK (110, 140, 170 et 210x70 et 120x55)					
	Acier			59	2501	25,10/m
	↔ 2 m  12 m	KSK40X20S KSK40X33S		59	2501	28,13/m
	Etrier pour canaux de blindage SK (1 pc. = 12 étriers)					
	Matière synthétique	blanc		59	2501	3,65/pc.
	 5 pc.	KPSK1HB				
	Câble de connexion pour canaux de blindage SK					
	Cuivre			59	2501	5,00/pc.
	↔ 110 mm  10 pc.	KPLSK				





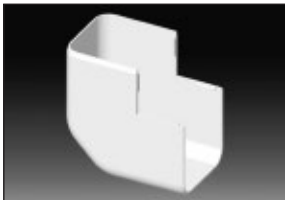





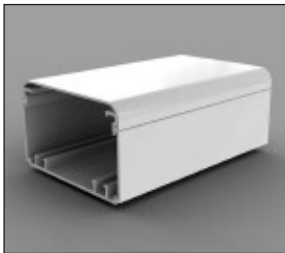

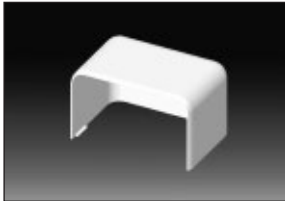

Systemes de gaines murales PK

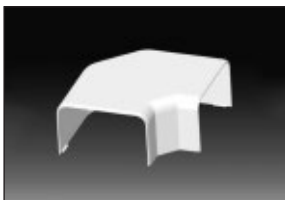
	type	référence	stock	page. catal.	groupe d'articles	prix en €	
	Prise simple 45X45, 3P16A230V, 45°, avec sécurité-enfants, blanc						
	Matière synthétique exempte d'halogènes	blanc	KQP45X45CHB	48	2501	12,52/pc.	
	 10 pc.						
	Prise simple 45X45, 3P16A230V, 45°, avec sécurité-enfants, rouge						
	Matière synthétique exempte d'halogènes	rouge	KQP45X45CBB	48	2501	13,49/pc.	
	 10 pc.						
	Boîte d'appareillage pour gaines murales PK (110, 140, 170 et 210X70)						
	Matière synthétique	blanc	KKPPKHB	✓	61	2501	5,31/pc.
	Matière synthétique exempte d'halogènes	blanc	KKPPKHFB	✓	56	2501	7,13/pc.
	 10 pc.						
	Adaptateur pour gaines murales PK (140 et 170X70)						
	Matière synthétique	blanc simple	K8440-11HB	✓	64	2501	3,59/pc.
	 10 pc.	blanc double	K8440-12HB	✓	64	2501	4,70/pc.
		blanc triple	K8440-13HB	✓	64	2501	7,67/pc.
	Adaptateur pour gaines murales PK (110 et 210X70)						
	Matière synthétique	blanc simple	K8450-11HB	✓	64	2501	3,79/pc.
	 10 pc.	blanc double	K8450-12HB	✓	64	2501	4,70/pc.
		blanc triple	K8450-13HB	✓	64	2501	7,67/pc.
	Matière synthétique exempte d'halogènes	blanc simple	K8450-11HFHB	✓	56	2501	6,44/pc.
	 10 pc.	blanc double	K8450-12HFHB	✓	56	2501	7,84/pc.
		blanc triple	K8450-13HFHB	✓	56	2501	12,54/pc.
	Support d'appareillage CEE pour gaines murales PK (140 et 170X70)						
	Acier		KPNPKS	✓	63	2501	48,47/pc.





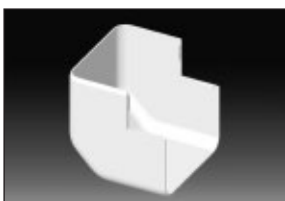







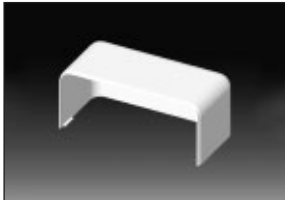

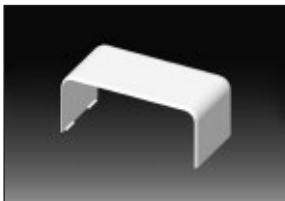
Canal d'alimentation EKE

	type	référence	 stock	page. catal.	groupe d'articles	prix en €
	Base + couvercle EKE 60x60					
Matière synthétique	blanc	KEKE60X60HD		36	2503	10,38/m
↔ 2 m  18 m						
	Embout EKE 60x60					
Matière synthétique	blanc	K8541HB		36	2503	12,96/pc.
 2 pc.						
	Accouplement EKE 60x60					
Matière synthétique	blanc	K8542HB		36	2503	12,96/pc.
 2 pc.						
	Angle plat EKE 60x60					
Matière synthétique	blanc	K8543HB		36	2503	19,53/pc.
 2 pc.						
	Pièce en T EKE 60x60					
Matière synthétique	blanc	K8544HB		36	2503	12,96/pc.
 2 pc.						
	Angle intérieur EKE 60x60					
Matière synthétique	blanc	K8545HB		36	2503	12,96/pc.
 2 pc.						
	Angle extérieur EKE 60x60					
Matière synthétique	blanc	K8546HB		36	2503	12,96/pc.
 2 pc.						





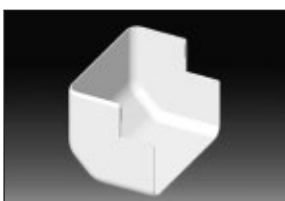







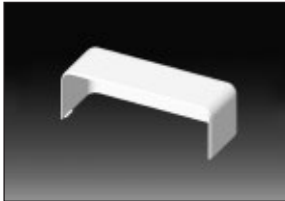

Systemes de gaines murales EKE

	type	référence	stock	page. catal.	groupe d'articles	prix en €
	Base + couvercle EKE 100x60					
	Matière synthétique ↔ 2 m  8 m	blanc	KEKE100X60HD	✓	37	2501
	Embout EKE 100x60					
	Matière synthétique  2 pc.	blanc	K8551HB		37	2506
	Accouplement EKE 100x60					
	Matière synthétique  2 pc.	blanc	K8552HB		37	2506
	Angle plat EKE 100x60					
	Matière synthétique  2 pc.	blanc	K8553HB		37	2506
	Pièce en T EKE 100x60					
	Matière synthétique  2 pc.	blanc	K8554HB		37	2506
	Angle intérieur EKE 100x60					
	Matière synthétique  2 pc.	blanc	K8555HB		37	2506
	Angle extérieur EKE 100x60					
	Matière synthétique  2 pc.	blanc	K8556HB		37	2506





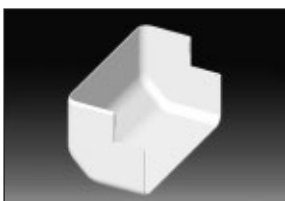







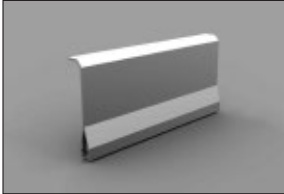

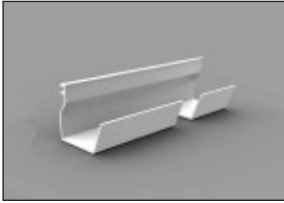

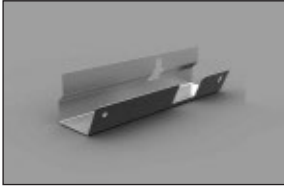
Systemes de gaines murales EKE

	type	référence	stock	page. catal.	groupe d'articles	prix en €
	Base + couvercle EKE 140x60					
	Matière synthétique ↔ 2 m  6 m	blanc	KEKE140X60HD	✓	38	2501
	Embout EKE 140x60					
	Matière synthétique  2 pc.	blanc	K8561HB		38	2506
	Accouplement EKE 140x60					
	Matière synthétique  2 pc.	blanc	K8562HB	✓	38	2506
	Angle plat EKE 140x60					
	Matière synthétique  2 pc.	blanc	K8563HB		38	2506
	Pièce en T EKE 140x60					
	Matière synthétique  2 pc.	blanc	K8564HB		38	2506
	Angle intérieur EKE 140x60					
	Matière synthétique  2 pc.	blanc	K8565HB		38	2506
	Angle extérieur EKE 140x60					
	Matière synthétique  2 pc.	blanc	K8566HB		38	2506

Systemes de gaines murales EKE

	type	référence	stock	page. catal.	groupe d'articles	prix en €
	Base + couvercle EKE 180x60					
	Matière synthétique ↔ 2 m  6 m	blanc	KEKE180X60HD	✓	39	2501
	Embout EKE 180x60					
	Matière synthétique  2 pc.	blanc	K8571HB		39	2506
	Accouplement EKE 180x60					
	Matière synthétique  2 pc.	blanc	K8572HB	✓	39	2506
	Angle plat EKE 180x60					
	Matière synthétique  2 pc.	blanc	K8573HB		39	2506
	Pièce en T EKE 180x60					
	Matière synthétique  2 pc.	blanc	K8574HB		39	2506
	Angle intérieur EKE 180x60					
	Matière synthétique  2 pc.	blanc	K8575HB		39	2506
	Angle extérieur EKE 180x60					
	Matière synthétique  2 pc.	blanc	K8576HB		39	2506











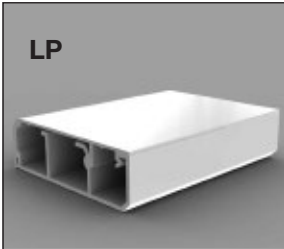

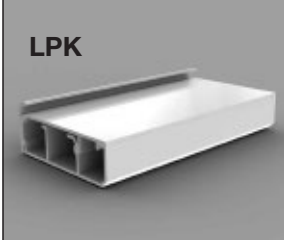
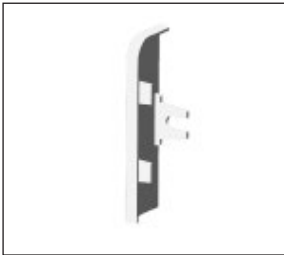
Systemes de gaines murales EKE

	type	référence	🌀 stock	page. catal.	groupe d'articles	prix en €
	Cloison de séparation H= 45 mm					
	Matière synthétique		✓	57	2501	6,35/m
	↔ 2 m  20 m	blanc KPEKE60C				
	Cloison de séparation H= 45 mm					
	Matière synthétique avec feuillet métallique	KPKS70/60		57	2501	10,34/m
	↔ 2 m  20 m					
	Cloison de séparation H= 42,5 mm					
	Matière synthétique			58	2501	12,54/m
	↔ 2 m  32 m	blanc KPEP60HD				
	Cloison de séparation H= 42,5 mm					
	Acier			58	2501	29,40/m
	↔ 2 m  24 m	KPEP60/KS				
	Boîte d'appareillage pour gaines murales EKE (100, 140 et 180X60)					
	Matière synthétique			61	2501	5,33/pc.
	 10 pc.	blanc KKPEKEHB				
	Adaptateur pour gaines murales EKE (100x60)					
	Matière synthétique			64	2501	3,78/pc.
	 2 pc.	blanc simple K8550-11HB		64	2501	4,70/pc.
		blanc double K8550-12HB		64	2501	5,89/pc.
		blanc triple K8550-13HB		64	2501	7,31/pc.
	Adaptateur pour gaines murales EKE (140x60)					
	Matière synthétique			64	2501	4,28/pc.
	 2 pc.	blanc simple K8560-11HB		64	2501	5,54/pc.
		blanc simple K8560-12HB		64	2501	7,31/pc.
		blanc simple K8560-13HB		64	2501	7,31/pc.
	Support d'appareillage CEE pour gaines murales EKE (140 et 180X60)					
	Acier			63	2501	48,47/pc.
		KPNEKES				
	Canal de blindage pour gaines murales EKE (100, 140 et 180x60)					
	Acier			59	2501	25,10/m
	↔ 2 m  12 m	KSK40X20S		59	2501	28,13/m
		KSK40X33S				











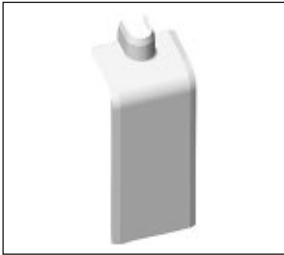

Canaux de plinthe et de plafond LP35

	type	référence	stock	page. catal.	groupe d'articles	prix en €	
	Base + couvercle LP 35X25						
	Matière synthétique						
	↔ 2 m  20 m	blanc	KLP35HD	32	2504	9,24/m	
		bouleau rose	KLP35I1	32	2504	18,80/m	
		chêne foncé	KLP35I2	32	2504	18,80/m	
		brun clair	KLP35SD	32	2504	13,59/m	
		brun foncé	KLP35TD	32	2504	13,59/m	
	Embout gauche LP 35X25						
	Matière synthétique	 10 pc.	blanc	K8861LHB	32	2504	3,82/pc.
			bouleau rose	K8861LI1	32	2504	8,24/pc.
			chêne foncé	K8861LI2	32	2504	8,24/pc.
			brun clair	K8861LSD	32	2504	8,24/pc.
	Embout droit LP 35X25						
	Matière synthétique	 10 pc.	blanc	K8861PHB	32	2504	3,82/pc.
			bouleau rose	K8861PI1	32	2504	8,24/pc.
			chêne foncé	K8861PI2	32	2504	8,24/pc.
			brun clair	K8861PSD	32	2504	8,24/pc.
	Angle intérieur LP 35X25						
	Matière synthétique	 10 pc.	blanc	K8865HB	32	2504	3,82/pc.
			bouleau rose	K8865I1	32	2504	8,24/pc.
			chêne foncé	K8865I2	32	2504	8,24/pc.
			brun clair	K8865SD	32	2504	4,22/pc.
	Angle extérieur LP 35X25						
	Matière synthétique	 10 pc.	blanc	K8866HB	32	2504	3,82/pc.
			bouleau rose	K8866I1	32	2504	8,24/pc.
			chêne foncé	K8866I2	32	2504	8,24/pc.
			brun clair	K8866SD	32	2504	4,22/pc.
	Boîte d'appareillage pour gaines LP 35X25						
	Matière synthétique	 10 pc.	blanc	KPNLP35ZHB	63	2504	6,57/pc.
			bouleau rose	KPNLP35ZI1	63	2504	12,71/pc.
			chêne foncé	KPNLP35ZI2	63	2504	12,71/pc.
			brun clair	KPNLP35ZSD	63	2504	10,42/pc.

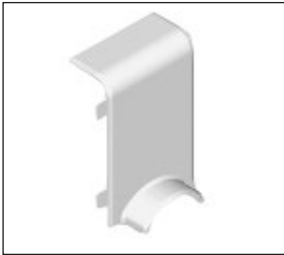









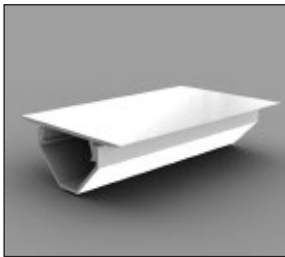

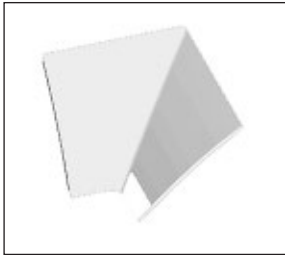
Canaux de plinthe LP80

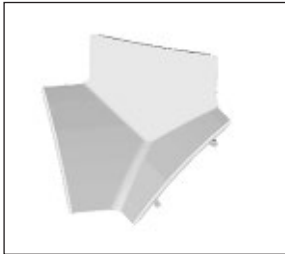
	type	référence	stock	page. catal.	groupe d'articles	prix en €
Base + couvercle LP 80X25 et LPK 80X25						
 <p>LP</p>	Matière synthétique					
	↔ 2 m  16 m	blanc	KLP80X25HD	30	2504	11,56/m
 <p>LPK</p>		blanc	KLPK80X25HD	31	2504	14,80/m
	Embout gauche et droit pour LP 80X25 et LPK 80X25					
	Matière synthétique					
	 10 pc.	blanc gauche	K8821LHB	30-31	2504	2,88/pc.
		blanc droit	K8821PHB	30-31	2504	2,88/pc.
Accouplement LP 80X25						
	Matière synthétique					
	 10 pc.	blanc	K8822HB	30-31	2504	2,88/pc.
Angle intérieur LP 80X25						
	Matière synthétique					
	 10 pc.	blanc	K8825HB	30-31	2504	3,91/pc.
Angle extérieur LP 80X25						
	Matière synthétique					
	 10 pc.	blanc	K8826HB	30-31	2504	3,91/pc.
Boîte d'appareillage pour gaines LP 80X25 et LPK 80X25						
	Matière synthétique					
	 10 pc.	blanc simple	KPN80X25HB	62	2504	7,52/pc.
		blanc double	KPN80X252ZHB	62	2504	7,77/pc.

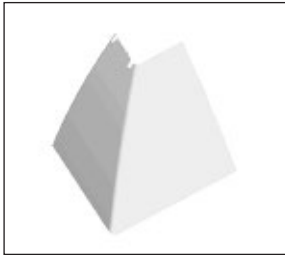



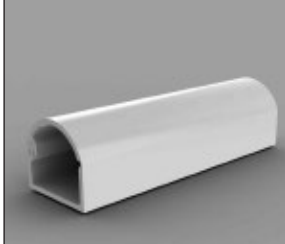









Canaux de plinthe LP80

	type	référence	 stock	page. catal.	groupe d'articles	prix en €
	Transition de LP(K) 80X25 vers LHD 20X20					
	Matière synthétique					
	 10 pc.	blanc	K8824/12HB	30-31	2504	3,91/pc.
	Transition de LP(K) 80X25 vers LZK 15X12					
	Matière synthétique					
	 10 pc.	blanc	K8824/40HB	30-31	2504	3,91/pc.
	Transition de LP(K) 80X25 vers LZ 15X12					
	Matière synthétique					
	 10 pc.	blanc	K8824/41HB	30-31	2504	3,91/pc.
	Transition de LP(K) 80X25 vers LO 35					
	Matière synthétique					
	 10 pc.	blanc	K8824/43HB	30-31	2504	3,91/pc.
	Transition de LP(K) 80X25 vers LO 50					
	Matière synthétique					
	 10 pc.	blanc	K8824/44HB	30-31	2504	3,91/pc.
	Transition de LP(K) 80X25 vers LHD 40X20					
	Matière synthétique					
	 10 pc.	blanc gauche	K8823/13LHB	30-31	2504	3,91/pc.
		blanc droit	K8823/13PHB	30-31	2504	3,91/pc.















Canal LR30 et canaux avec couvercle à charnière LZ

	type	référence	📦 stock	page. catal.	groupe d'articles	prix en €
	Base + couvercle LR30					
	Matière synthétique ↔ 2 m  26 m	KLR30HB	29	2504	11,88/m	
	Angle intérieur LR30					
	Matière synthétique  5 pc.	K8855HB	29	2504	2,12/pc.	
	Angle intérieur 3 entrées LR30					
	Matière synthétique  5 pc.	K8855/3HB	29	2504	2,12/pc.	
	Angle extérieur LR30					
	Matière synthétique  10 pc.	K8856HB	29	2504	2,12/pc.	
	Base + couvercle à charnière LZ 15X12					
	Matière synthétique ↔ 2 m  96 m	blanc K LZ15X12HD	8	2503	1,32/m	
	Base + couvercle à charnière rond LZK 15X12					
	Matière synthétique ↔ 2 m  96 m	blanc K LZK15X12HD	9	2503	1,32/m	





Canaux de sol LO

		type	référence	stock	page. catal.	groupe d'articles	prix en €	
	Base + couvercle LO 35							
	Matière synthétique							
	↔ 2 m		60 m	blanc	KL035HD	26	2504	5,41/m
				blanc + autoc.	KL035P2	26	2504	5,70/m
				gris clair	KL035KD	26	2504	7,38/m
				gris foncé	KL035LD	26	2504	7,38/m
	Angle plat		2 pc.	blanc	K8833HB	26	2504	2,98/pc.
				gris clair	K8833KB	26	2504	2,98/pc.
				gris foncé	K8833LB	26	2504	2,98/pc.
	Pièce en T		2 pc.	blanc	K8834HB	26	2504	2,72/pc.
gris clair				K8834KB	26	2504	2,72/pc.	
gris foncé				K8834LB	26	2504	2,72/pc.	
	Base + couvercle LO 50							
	Matière synthétique							
	↔ 2 m		32 m	blanc	KL050HD	27	2504	7,71/m
				blanc + autoc.	KL050P2	27	2504	8,65/m
				gris clair	KL050KD	27	2504	7,71/m
				gris foncé	KL050LD	27	2504	7,71/m
	Angle plat		2 pc.	blanc	K8843HB	27	2504	3,31/pc.
				gris clair	K8843KB	27	2504	3,31/pc.
				gris foncé	K8843LB	27	2504	3,31/pc.
	Pièce en T		2 pc.	blanc	K8844HB	27	2504	3,14/pc.
gris clair				K8844KB	27	2504	3,14/pc.	
gris foncé				K8844LB	27	2504	3,14/pc.	
	Base + couvercle LO 75							
	Matière synthétique							
	↔ 2 m		28 m	blanc	KL075HD	28	2504	10,15/m
				blanc + autoc.	KL075P2	28	2504	12,64/m
				gris clair	KL075KD	28	2504	10,15/m
				gris foncé	KL075LD	28	2504	10,15/m
	Angle plat		2 pc.	blanc	K8873HB	28	2504	3,89/pc.
				gris clair	K8873KB	28	2504	3,89/pc.
				gris foncé	K8873LB	28	2504	3,89/pc.
	Pièce en T		2 pc.	blanc	K8874HB	28	2504	3,47/pc.
gris clair				K8874KB	28	2504	3,47/pc.	
gris foncé				K8874LB	28	2504	3,47/pc.	
	Pince pour réaliser des ouvertures							
	Matière synthétique / acier							
				KVK20	65	2503	323,40/pc.	
	Pince pour canaux jusqu'à 40X20 mm ou 40 mm							
	Matière synthétique / acier							
				KL-42W	65	2503	188,54/pc.	













Canaux d'alimentation LV, LH, LHD et EKD

	type	référence	stock	page. catal.	groupe d'articles	prix en €	
	Base + couvercle LV 11X10						
	Matière synthétique						
	↔ 2 m	 150 m	blanc KLV11X10HD blanc + autoc. KLV11X10P2	4 4	2503 2503	0,97/m 1,83/m	
	Base + couvercle LV 18X13						
	Matière synthétique						
	↔ 2 m	 70 m	blanc KLV18X13HD blanc + autoc. KLV18X13P2 brun clair KLV18X13SD brun foncé KLV18X13TD	5 5 5 5	2503 2503 2503 2503	1,34/m 2,38/m 1,80/m 1,80/m	
	Embout		blanc K8731HB	5	2503	0,99/pc.	
	Accouplement		blanc K8732HB	5	2503	0,99/pc.	
	Angle plat	 10 pc.	blanc K8733HB	5	2503	1,50/pc.	
	Pièce en T		blanc K8734HB	5	2503	1,50/pc.	
	Angle intérieur		blanc K8735HB	5	2503	1,50/pc.	
	Angle extérieur		blanc K8736HB	5	2503	1,50/pc.	
		Base + couvercle LV 24X22					
Matière synthétique							
↔ 2 m		 40 m	blanc KLV24X22HD	6	2503	2,11/m	
		 30 m	blanc + autoc. KLV24X22P2	6	2503	3,64/m	
Embout			blanc K8791HB	6	2503	1,13/pc.	
Accouplement			blanc K8792HB	6	2503	1,13/pc.	
Angle plat		 10 pc.	blanc K8793HB	6	2503	1,62/pc.	
Pièce en T			blanc K8794HB	6	2503	1,62/pc.	
Angle intérieur			blanc K8795HB	6	2503	1,62/pc.	
Angle extérieur			blanc K8796HB	6	2503	1,62/pc.	
	Base + couvercle LV 40X15						
	Matière synthétique						
	↔ 2 m	 30 m	blanc KLV40X15HD blanc + autoc. KLV40X15P2	7 7	2503 2503	4,17/m 5,30/m	
	Embout		blanc K8711HB	7	2503	1,72/pc.	
	Accouplement		blanc K8714HB	7	2503	1,72/pc.	
	Angle plat	 10 pc.	blanc K8716HB	7	2503	2,01/pc.	
	Pièce en T		blanc K8715HB	7	2503	2,01/pc.	
	Angle intérieur		blanc K8713/2HB	7	2503	2,01/pc.	
	Angle extérieur		blanc K8712/2HB	7	2503	2,01/pc.	
		Base + couvercle LH 15X10					
Matière synthétique							
↔ 2 m		 128 m	blanc KLV15X10HD blanc + autoc. KLV15X10P2	✓ ✓	10 10	2503 2503	1,00/m 1,86/m
Embout			blanc K8681HB	10	2503	0,80/pc.	
Accouplement			blanc K8682HB	10	2503	0,80/pc.	
Angle plat		 10 pc.	blanc K8683HB	10	2503	1,19/pc.	
Pièce en T			blanc K8684HB	10	2503	1,19/pc.	
Angle intérieur			blanc K8685HB	10	2503	1,19/pc.	
Angle extérieur			blanc K8686HB	10	2503	1,19/pc.	













Canaux d'alimentation LV, LH, LHD et EKD

	type	référence	🌀 stock	page. catal.	groupe d'articles	prix en €	
	Base + couvercle LHD 17X17						
	Matière synthétique						
	↔ 2 m	📦 70 m	blanc KLHD17X17HD	11	2503	1,39/m	
			blanc + autoc. KLHD17X17P2	11	2503	2,11/m	
	Embout		blanc K8671HB	11	2503	1,01/pc.	
	Accouplement		blanc K8672HB	11	2503	1,01/pc.	
	Angle plat	📦 10 pc.	blanc K8673HB	11	2503	1,50/pc.	
	Pièce en T		blanc K8674HB	11	2503	1,50/pc.	
	Angle intérieur		blanc K8675HB	11	2503	1,50/pc.	
	Angle extérieur		blanc K8676HB	11	2503	1,50/pc.	
	Base + couvercle LHD 20X10						
	Matière synthétique						
	↔ 2 m	📦 96 m	blanc KLHD20X10HD	12	2503	1,27/m	
			blanc + autoc. KLHD20X10P2	✓	12	2503	2,21/m
	Embout		blanc K8921HB	12	2503	1,01/pc.	
	Accouplement		blanc K8922HB	12	2503	1,01/pc.	
	Angle plat	📦 10 pc.	blanc K8923HB	12	2503	1,50/pc.	
	Pièce en T		blanc K8924HB	12	2503	1,50/pc.	
	Angle intérieur		blanc K8925HB	12	2503	1,50/pc.	
	Angle extérieur		blanc K8926HB	12	2503	1,50/pc.	
	Base + couvercle LHD 20X10 HF						
	Matière synthétique exempte d'halogènes						
	↔ 2 m	📦 60 m	blanc KLHD20X10HFHD	✓	49	2503	4,49/m
	Embout		blanc K8921HFHB	✓	49	2503	3,25/pc.
	Accouplement		blanc K8922HFHB	✓	49	2503	3,25/pc.
	Angle plat	📦 10 pc.	blanc K8923HFHB	✓	49	2503	4,80/pc.
	Pièce en T		blanc K8924HFHB	✓	49	2503	4,80/pc.
	Angle intérieur		blanc K8925HFHB	✓	49	2503	4,80/pc.
	Angle extérieur		blanc K8926HFHB	✓	49	2503	4,80/pc.
		Base + couvercle LHD 20X20					
Matière synthétique							
↔ 2 m		📦 48 m	blanc KLHD20X20HD	✓	13	2503	1,72/m
			blanc + autoc. KLHD20X20P2		13	2503	2,94/m
			brun clair KLHD20X20SD		13	2503	2,14/m
			brun foncé KLHD20X20TD		13	2503	2,14/m
↔ 2 m		📦 24 m	bouleau rose KLHD20X20I1		13	2503	16,00/m
			chêne foncé KLHD20X20I2		13	2503	16,00/m
Embout			blanc K8621HB	✓	13	2503	1,07/pc.
Accouplement			blanc K8622HB		13	2503	1,07/pc.
Angle plat	📦 10 pc.	blanc K8623HB		13	2503	1,69/pc.	
Pièce en T		blanc K8624HB		13	2503	1,69/pc.	
Angle intérieur		blanc K8625HB	✓	13	2503	1,69/pc.	
Angle extérieur		blanc K8626HB		13	2503	1,69/pc.	













Canaux d'alimentation LV, LH, LHD et EKD

	type	référence	stock	page. catal.	groupe d'articles	prix en €		
	Base + couvercle LHD 20X20 HF							
	Matière synthétique exempte d'halogènes							
	↔ 2 m	 24 m	blanc	KLHD20X20HFHD	✓	50	2503	6,91/m
	Embout		blanc	K8621HFHB	✓	50	2503	3,53/pc.
	Accouplement		blanc	K8622HFHB	✓	50	2503	3,53/pc.
	Angle plat	 10 pc.	blanc	K8623HFHB	✓	50	2503	5,15/pc.
	Pièce en T		blanc	K8624HFHB	✓	50	2503	5,15/pc.
Angle intérieur	blanc		K8625HFHB	✓	50	2503	5,15/pc.	
Angle extérieur		blanc	K8626HFHB	✓	50	2503	5,15/pc.	
	Base + couvercle LHD 25X15							
	Matière synthétique							
	↔ 2 m	 50 m	blanc	KLHD25X15HD		14	2503	1,70/m
			blanc + autoc.	KLHD25X15P2		14	2503	2,94/m
	Embout		blanc	K8691HB		14	2503	1,11/pc.
	Accouplement		blanc	K8692HB		14	2503	1,11/pc.
	Angle plat	 10 pc.	blanc	K8693HB		14	2503	1,71/pc.
Pièce en T	blanc		K8694HB		14	2503	1,71/pc.	
Angle intérieur	blanc		K8695HB		14	2503	1,71/pc.	
Angle extérieur		blanc	K8696HB		14	2503	1,71/pc.	
	Base + couvercle LHD 25X20							
	Matière synthétique							
	↔ 2 m	 40 m	blanc	KLHD25X20HD		15	2503	2,08/m
			blanc + autoc.	KLHD25X20P2		15	2503	3,32/m
	Embout		blanc	K8911HB		15	2503	1,13/pc.
	Accouplement		blanc	K8912HB		15	2503	1,13/pc.
	Angle plat	 10 pc.	blanc	K8913HB		15	2503	1,62/pc.
Pièce en T	blanc		K8914HB		15	2503	1,62/pc.	
Angle intérieur	blanc		K8915HB		15	2503	1,62/pc.	
Angle extérieur		blanc	K8916HB		15	2503	1,62/pc.	
	Base + couvercle LHD 30X25							
	Matière synthétique							
	↔ 2 m	 48 m	blanc	KLHD30X25HD	✓	16	2503	2,34/m
			blanc + autoc.	KLHD30X25P2		16	2503	3,47/m
	Embout		blanc	K8931HB		16	2503	1,65/pc.
	Accouplement		blanc	K8932HB		16	2503	1,65/pc.
	Angle plat	 10 pc.	blanc	K8933HB		16	2503	2,33/pc.
Pièce en T	blanc		K8934HB		16	2503	2,33/pc.	
Angle intérieur	blanc		K8935HB		16	2503	2,33/pc.	
Angle extérieur		blanc	K8936HB		16	2503	2,33/pc.	









Canaux d'alimentation LV, LH, LHD et EKD

	type	référence	stock	page. catal.	groupe d'articles	prix en €
Base + couvercle LHD 32X15						
Matière synthétique						
	↔ 2 m	 88 m blanc	KLHD32X15HD	✓	17 2503	1,98/m
		 80 m blanc + autoc.	KLHD32X15P2		17 2503	3,29/m
	Embout	blanc	K8601HB	✓	17 2503	1,11/pc.
	Accouplement	blanc	K8602HB	✓	17 2503	1,11/pc.
	Angle plat	blanc	K8603HB	✓	17 2503	1,69/pc.
	Pièce en T	 10 pc. blanc	K8604HB	✓	17 2503	1,69/pc.
	Angle intérieur	blanc	K8605HB	✓	17 2503	1,69/pc.
	Angle extérieur	blanc	K8606HB	✓	17 2503	1,69/pc.
Base + couvercle LHD 40X20						
Matière synthétique						
	↔ 2 m	blanc	KLHD40X20HD	✓	18 2503	2,70/m
		blanc + autoc.	KLHD40X20P2		18 2503	4,22/m
		brun clair	KLHD40X20SD		18 2503	4,13/m
		brun foncé	KLHD40X20TD		18 2503	4,13/m
	 12 m	bouleau rose	KLHD40X20I1		18 2503	18,60/m
		chêne foncé	KLHD40X20I2		18 2503	18,60/m
	Embout	blanc	K8631HB	✓	18 2503	2,04/pc.
	Accouplement	blanc	K8632HB	✓	18 2503	2,04/pc.
	Angle plat	blanc	K8633HB	✓	18 2503	2,76/pc.
	Pièce en T	 10 pc. blanc	K8634HB	✓	18 2503	2,76/pc.
	Angle intérieur	blanc	K8635HB	✓	18 2503	2,76/pc.
	Angle extérieur	blanc	K8636HB	✓	18 2503	2,76/pc.
Base + couvercle LHD 40X20 HF						
Matière synthétique exempte d'halogènes						
	↔ 2 m	 12 m blanc	KLHD40X20HFHD	✓	51 2503	11,41/m
		Embout	blanc	K8631HFHB	✓	51 2503
	Accouplement	blanc	K8632HFHB	✓	51 2503	6,16/pc.
	Angle plat	blanc	K8633HFHB	✓	51 2503	8,66/pc.
	Pièce en T	 10 pc. blanc	K8634HFHB	✓	51 2503	8,66/pc.
	Angle intérieur	blanc	K8635HFHB	✓	51 2503	8,66/pc.
	Angle extérieur	blanc	K8636HFHB	✓	51 2503	8,66/pc.
Base + couvercle LHD 40X40						
Matière synthétique						
	↔ 2 m	blanc	KLHD40X40HD		19 2503	4,33/m
		brun clair	KLHD40X40SD		19 2503	8,40/m
		brun foncé	KLHD40X40TD		19 2503	8,40/m
	Embout	blanc	K8641HB		19 2503	2,53/pc.
	Accouplement	blanc	K8642HB		19 2503	2,53/pc.
	Angle plat	blanc	K8643HB		19 2503	3,32/pc.
	Pièce en T	 10 pc. blanc	K8644HB		19 2503	3,32/pc.
	Angle intérieur	blanc	K8645HB		19 2503	3,32/pc.
	Angle extérieur	blanc	K8646HB		19 2503	3,32/pc.

Canaux d'alimentation LV, LH, LHD et EKD

	type	référence	stock	page. catal.	groupe d'articles	prix en €		
	Base + couvercle LHD 40X40 HF							
	Matière synthétique exempte d'halogènes							
	↔ 2 m	 12 m	blanc	KLHD40X40HFHD	✓	52	2503	16,95/m
	Embout		blanc	K8641HFHB	✓	52	2503	7,84/pc.
	Accouplement		blanc	K8642HFHB	✓	52	2503	7,84/pc.
	Angle plat	 10 pc.	blanc	K8643HFHB	✓	52	2503	8,81/pc.
	Pièce en T		blanc	K8644HFHB	✓	52	2503	8,81/pc.
	Angle intérieur		blanc	K8645HFHB	✓	52	2503	8,81/pc.
	Angle extérieur		blanc	K8646HFHB	✓	52	2503	8,81/pc.
		Base + couvercle LHD 50x20, LHD 50x20/1 et LHD 50x20/2						
Matière synthétique								
↔ 2 m		 32 m	blanc	KLHD50X20HD		20	2503	3,52/m
			blanc	KLHD50X20/1HD		20	2503	3,74/m
			blanc	KLHD50X20/2HD		20	2503	4,02/m
Embout			blanc	K8991HB		20	2503	2,12/pc.
Accouplement			blanc	K8992HB		20	2503	2,12/pc.
Angle plat		 10 pc.	blanc	K8993HB		20	2503	3,01/pc.
Pièce en T			blanc	K8994HB		20	2503	3,01/pc.
Angle intérieur			blanc	K8995HB		20	2503	3,01/pc.
Angle extérieur		blanc	K8996HB		20	2503	3,01/pc.	
	Base + couvercle LH 60x40							
	Matière synthétique							
	↔ 2 m	 16 m	blanc	KLH60X40HD	✓	21	2503	7,95/m
	Embout		blanc	K8651HB		21	2503	2,96/pc.
	Accouplement		blanc	K8652HB	✓	21	2503	2,96/pc.
	Angle plat	 10 pc.	blanc	K8653HB		21	2503	4,02/pc.
	Pièce en T		blanc	K8654HB		21	2503	4,02/pc.
	Angle intérieur		blanc	K8655HB		21	2503	4,02/pc.
	Angle extérieur		blanc	K8656HB		21	2503	4,02/pc.
	Angle plat rond	 2 pc.	blanc	K8653RHB		21	2503	4,02/pc.
Pièce en T ronde		blanc	K8654RHB		21	2503	4,02/pc.	
	Base + couvercle EKD 80X40							
	Matière synthétique							
	↔ 2 m	 10 m	blanc	KEKD80X40HD		33	2503	9,68/m
	Embout		blanc	K8501HB		33	2503	4,47/pc.
	Accouplement		blanc	K8502HB		33	2503	4,47/pc.
	Angle plat		blanc	K8503HB		33	2503	6,35/pc.
	Pièce en T	 2 pc.	blanc	K8504HB		33	2503	6,11/pc.
	Dérivation		blanc	K8504/EKDHB		33	2503	5,76/pc.
	Angle intérieur		blanc	K8505HB		33	2503	6,35/pc.
	Angle extérieur		blanc	K8506HB		33	2503	6,35/pc.

Canaux d'alimentation LV, LH, LHD et EKD

	type	référence	stock	page. catal.	groupe d'articles	prix en €	
	Base + couvercle EKD 80X40 HF						
	Matière synthétique exempte d'halogènes						
	↔ 2 m	 10 m	blanc	KEKD80X40HFHD	53	2503	29,74/m
	Embout		blanc	K8501HFHB	53	2503	12,48/pc.
	Accouplement		blanc	K8502HFHB	53	2503	12,48/pc.
	Angle plat		blanc	K8503HFHB	53	2503	16,48/pc.
	Pièce en T	 2 pc.	blanc	K8504HFHB	53	2503	16,48/pc.
	Angle intérieur		blanc	K8505HFHB	53	2503	16,48/pc.
	Angle extérieur		blanc	K8506HFHB	53	2503	16,48/pc.
		Base + couvercle EKD 100X40					
Matière synthétique							
↔ 2 m		 8 m	blanc	KEKD100X40HD	34	2503	11,41/m
Embout			blanc	K8511HB	34	2503	5,89/pc.
Accouplement			blanc	K8512HB	34	2503	5,89/pc.
Angle plat			blanc	K8513HB	34	2503	7,77/pc.
Pièce en T		 2 pc.	blanc	K8514HB	34	2503	7,77/pc.
Dérivation			blanc	K8514/EKDHB	34	2503	7,77/pc.
Angle intérieur			blanc	K8515HB	34	2503	7,77/pc.
Angle extérieur			blanc	K8516HB	34	2503	7,77/pc.
	Base + couvercle EKD 120x40						
	Matière synthétique						
	↔ 2 m	 8 m	blanc	KEKD120X40HD	35	2503	13,49/m
	Embout		blanc	K8581HB	35	2503	6,28/pc.
	Accouplement		blanc	K8582HB	35	2503	6,28/pc.
	Angle plat		blanc	K8583HB	35	2503	9,42/pc.
	Pièce en T	 2 pc.	blanc	K8584HB	35	2503	9,42/pc.
	Dérivation		blanc	K8584/EKDHB	35	2503	9,42/pc.
	Angle intérieur		blanc	K8585HB	35	2503	9,42/pc.
	Angle extérieur		blanc	K8586HB	35	2503	9,42/pc.

Canaux de câblage RK

	type	référence	stock	page. catal.	groupe d'articles	prix en €	
<p>profondeur ↗ hauteur ↘</p>	Base + couvercle RK...X...						
	Matière synthétique gris pierre RAL 7030						
	↔ 2 m						
	hauteur x profondeur						
		64 m	30x30	KRK30X30LD	68	2505	7,40/m
		60 m	30x40	KRK30X40LD	68	2505	8,72/m
		48 m	40x60	KRK40X60LD	✓ 68	2505	8,88/m
	📦	36 m	60x60	KRK60X60LD	✓ 68	2505	11,53/m
		32 m	80x60	KRK80X60LD	✓ 68	2505	16,12/m
		22 m	100x60	KRK100X60LD	✓ 68	2505	17,21/m
	40 m	40x80	KRK40X80LD	✓ 68	2505	10,91/m	
	36 m	60x80	KRK60X80LD	✓ 68	2505	12,85/m	
<p>profondeur ↗ hauteur ↘</p>	Base + couvercle RK...X...HF						
	Matière synthétique exempte d'halogènes gris clair RAL 7035						
	↔ 2 m						
	hauteur x profondeur						
	📦	40 m	37,5x37,5	KRK37.5X37.5HFLD	69	2505	17,36/m
	32 m	37,5x50	KRK37.5X50HFLD	69	2505	22,16/m	
	42 m	50x50	KRK50X50HFLD	69	2505	23,84/m	
	Canal de câblage flexible RK-OVK						
	Matière synthétique gris pierre RAL 7030						
	↔ 0,5 m						
	📦	60 pc.	∅20	KRK-OVK20LA	69	2505	10,67/pc.
	36 pc.	∅30	KRK-OVK30LB	69	2505	11,21/pc.	
	24 pc.	∅40	KRK-OVK40LB	69	2505	12,97/pc.	
	Canal de câblage en spirale RK-ST						
	Matière synthétique						
	📦	25 m	∅6	KRK-ST6H25	69	2505	1,62/m
		20 m	∅12	KRK-ST12H20	69	2505	2,62/m
	25 m	∅22	KRK-ST22H25	69	2505	7,04/m	

Colonnes de distribution et de bureau

Fonctionnalité supérieure design élané

- ✓ disponible en version simple et double
- ✓ en aluminium anodisé ou blanc laqué RAL 9010
- ✓ les mécanismes 45x45 mm s'encliquettent directement dans l'ouverture du couvercle, sans faire usage de boîtes d'appareillage
- ✓ montage simple et rapide
- ✓ 3 types : installés comme colonne de bureau fixe, comme colonne tendue entre le plafond et le sol ou comme colonne mobile
- ✓ plusieurs accessoires et finitions possibles.

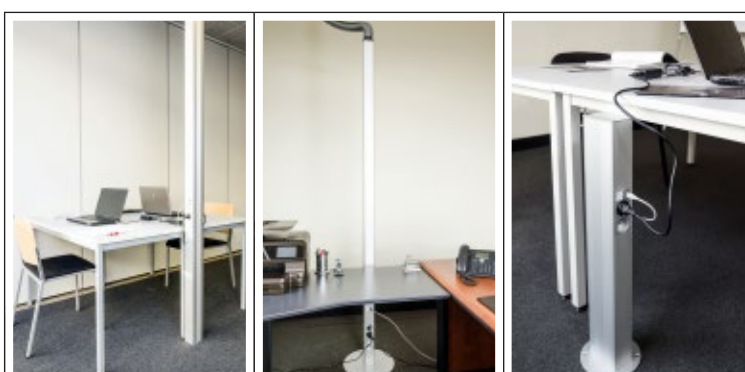
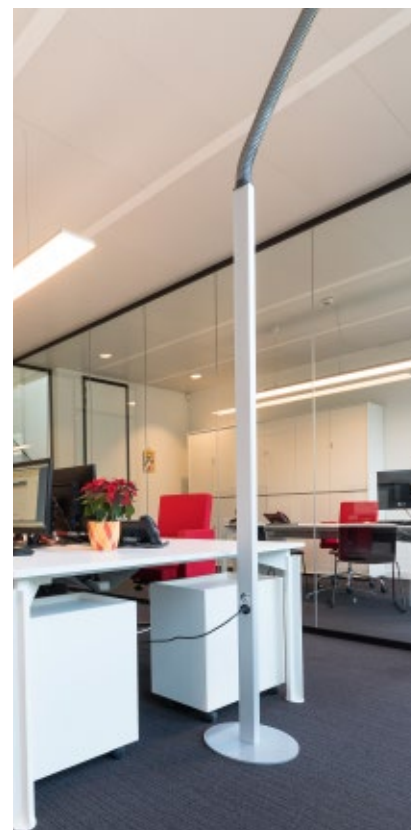

Caractéristiques	Tendue entre le sol et le plafond	Libre et mobile	Colonne de bureau
Aluminium, anodisé	✓	✓	✓
Aluminium, blanc laqué RAL 9010	✓	✓	✓
Dimensions (mm)	Profilé (plage de réglage) 2550 (2670-3070) 2750 (2870-3270) 3050 (3170-3570) 4000 (4120-4520)	Profilé (flexible) 2150 (2000) Diamètre socle 350	Profilé 683 Diamètre socle 170
Version simple	✓	✓	✓
Version double	✓	✓	✓
Mécanismes 45x45mm	✓	✓	✓
	page 224-225	page 226-227	page 228

Colonnes de distribution IDT

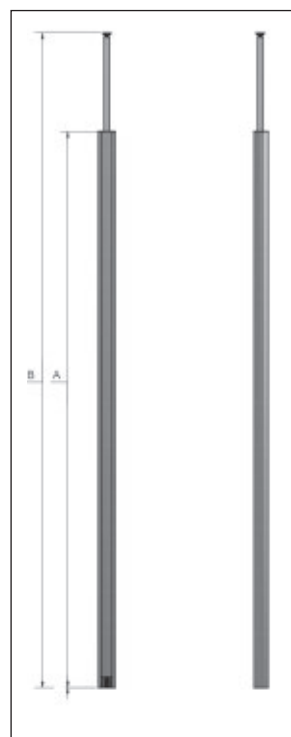

Colonne de distribution tendue entre le sol et le plafond, simple

type	référence	stock	page. catal.	groupe d'articles	prix en €	
Aluminium						
A	B					
2550	2670-3070 anodisé blanc laqué	IDT6305 IDT6302	✓ ✓	5 5	2701 2701	310,12/pc. 310,12/pc.
2750	2870-3270 anodisé blanc laqué	IDT6306 IDT6303	✓ ✓	5 5	2701 2701	323,76/pc. 323,76/pc.
3050	3170-3570 anodisé blanc laqué	IDT6307 IDT6304	✓ ✓	5 5	2701 2701	343,61/pc. 343,61/pc.
4000	4120-4520 anodisé blanc laqué	IDT7218 IDT7239	✓ ✓	5 5	2701 2701	473,83/pc. 473,83/pc.



Plaque de plafond, simple



Matière synthétique	blanc	IDT2917	✓	5	2701	10,29/pc.
---------------------	-------	---------	---	---	------	-----------



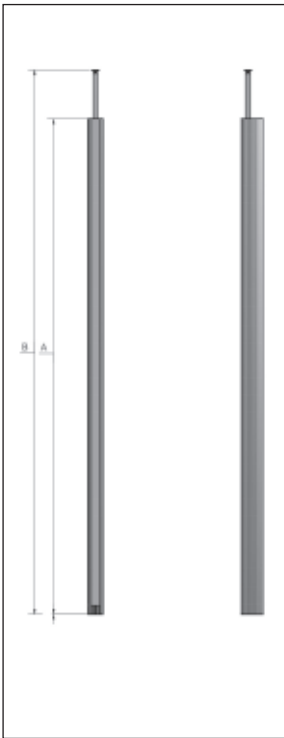

Set avec conducteur de terre et serre-câbles

IDT6894	✓	5	2701	12,53/pc.
---------	---	---	------	-----------

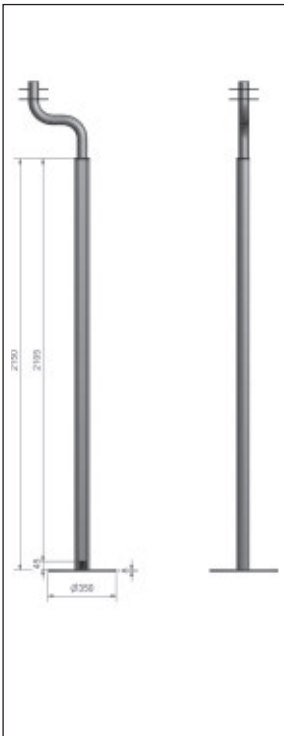
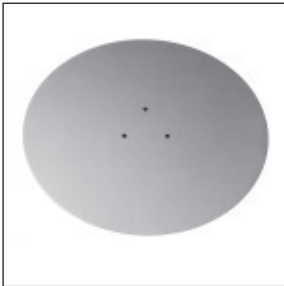

Colonnes de distribution IDT

	type	référence	📦 stock	page. catal.	groupe d'articles	prix en €	
Colonne de distribution tendue entre le sol et le plafond, double							
	Aluminium						
		A	B				
	2550	2670-3070					
		anodisé	IDT0022	✓	5	2701	434,31/pc.
		blanc laqué	IDT0019	✓	5	2701	434,31/pc.
	2750	2870-3270					
		anodisé	IDT0023	✓	5	2701	457,68/pc.
		blanc laqué	IDT0020	✓	5	2701	457,68/pc.
	3050	3170-3570					
		anodisé	IDT0024	✓	5	2701	491,87/pc.
		blanc laqué	IDT0021	✓	5	2701	491,87/pc.
	4000	4120-4520					
	anodisé	IDT7219	✓	5	2701	749,12/pc.	
	blanc laqué	IDT7240	✓	5	2701	749,12/pc.	
Plaque de plafond, double							
	Matière synthétique						
		blanc	IDT6893	✓	5	2701	13,67/pc.
Set avec conducteur de terre et serre-câbles							
							
			IDT6894	✓	5	2701	12,53/pc.

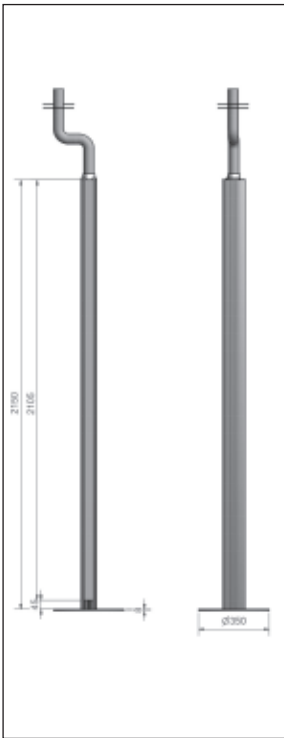
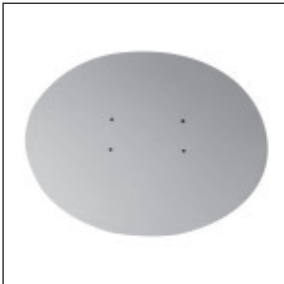

Colonnes de distribution IDT

	type	référence	📦 stock	page. catal.	groupe d'articles	prix en €
	Colonne de distribution mobile, simple la plaque de plafond en acier laqué blanc et le flexible gris ou blanc L=2000 mm sont inclus					
	Aluminium	A				
	2150	anodisé blanc laqué	IDT6301 IDT6300	✓ ✓	7 7	2701 2701
	Le socle est à commander séparément.					
	Socle pour colonne de distribution mobile, simple					
	Acier					
		gris laqué blanc laqué	IDT2941 IDT2942	✓ ✓	7 7	2701 2701
	Set avec conducteur de terre et serre-câbles					
			IDT6894	✓	7	2701

Colonnes de distribution IDT

	type	référence	📦 stock	page. catal.	groupe d'articles	prix en €
	Colonne de distribution mobile, double la plaque de plafond en acier laqué blanc et le flexible gris ou blanc L=2000 mm sont inclus					
	Aluminium	A				
	2150	anodisé blanc laqué	IDT0010 IDT0009	✓ ✓	7 7	2701 2701
	Le socle est à commander séparément.					
	Socle pour colonne de distribution mobile, double					
	Acier					
		gris laqué blanc laqué	IDT0011 IDT0012	✓ ✓	7 7	2701 2701
	Set avec conducteur de terre et serre-câbles					
			IDT6894	✓	7	2701

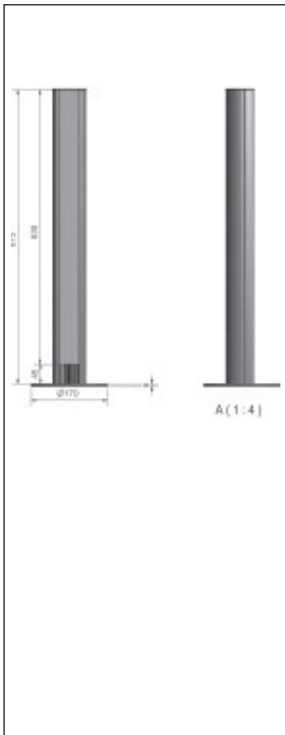
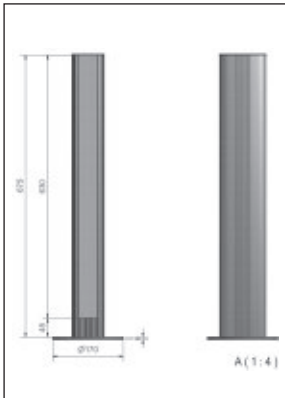
Colonnes de distribution IDT

	type	référence	stock	page. catal.	groupe d'articles	prix en €
Colonne de bureau, simple						
	Aluminium	anodisé	✓	9	2701	177,83/pc.
		blanc	IDT6299	✓	9	2701
<p>Le socle rond est déjà fixé au profilé de la colonne de bureau.</p>						
Colonne de bureau, double						
	Aluminium	anodisé	✓	9	2701	237,10/pc.
		blanc	IDT0004	✓	9	2701
<p>Le socle rond est déjà fixé au profilé de la colonne de bureau.</p>						
Set avec conducteur de terre et serre-câbles						
		IDT6894	✓	9	2701	12,53/pc.



Connexions bureautiques

Les connexions bureautiques **IBCONNECT** sont la solution idéale pour équiper tout lieu de travail de façon confortable et fonctionnelle de raccords pour des applications voix, données et multimédia ainsi que des prises électriques nécessaires. Une solution pour chaque application.

Grâce aux connexions bureautiques **IBCONNECT**, divers postes de travail, meubles de bureau et installations multimédia professionnelles répondent aux besoins actuels et futurs.



Box (page 233-235)



Cubo (page 232)



Cap (page 231)



Intro (page 236-238)



Prisma **N** (page 239-240)



Top (page 230)



Meeting (page 230)



Unit **N** (page 241)



Lumen (page 243)



PDC **N** (page 230)



Orgatech (page 242)

Connexions bureautiques: PDC, TOP, MEETING



PDC – point de distribution 230V

En fonction de vos besoins, le PDC devient un point de distribution électrique pour une alimentation 230V.



PDC – point de distribution RJ45

En fonction de vos besoins, le PDC devient un point de distribution pour la transmission de données.



TOP

Boîtier de raccordement intégré à commande électrique. Les prises de courant et les raccordements de données et multimédia peuvent être combinés d'un côté.



MEETING

Boîtier de raccordement intégré à commande électrique. Les prises de courant et les raccordements de données et multimédia peuvent être combinés des deux côtés.

Configuration des types susmentionnés en fonction de vos besoins.

Connexions bureautiques: CAP

	type	référence	 stock	page. catal.	groupe d'articles	prix en €
	CAP Aluminium	blanc	44201004/1		2403	77,79/pc.
	CAP Aluminium	noir	44201004/2		2403	77,79/pc.
	CAP Aluminium	gris	44201004/4		2403	77,79/pc.
	CAP Plus Aluminium	noir	44202004/2		2403	97,32/pc.
	CAP Plus Aluminium	gris	44202004/4		2403	97,32/pc.

Connexions bureautiques: CUBO

	type	référence	📦 stock	page. catal.	groupe d'articles	prix en €
	CUBO 3 prises de courant + 1 espace vide (45x45) Profilé en aluminium laqué en blanc et mécanismes blancs	32102001F1			2401	55,71/pc.
	CUBO 3 prises de courant + 1 espace vide (45x45) Profilé en aluminium laqué en noir et mécanismes en anthracite	32102001F3	✓		2401	55,71/pc.
	CUBO 3 prises de courant + 2 espaces vides (45x45) Profilé en aluminium laqué en blanc et mécanismes blancs	32102002F1			2401	60,12/pc.
	CUBO 3 prises de courant + 2 espaces vides (45x45) Profilé en aluminium laqué en noir et mécanismes en anthracite	32102002F3			2401	60,12/pc.
	CUBO 4 prises de courant + support Profilé en aluminium laqué en blanc et mécanismes blancs	33106003F1			2401	73,23/pc.
	CUBO 4 prises de courant + support Profilé en aluminium laqué en noir et mécanismes en anthracite	33106003F3			2401	73,23/pc.



Connexions bureautiques: BOX

	type	référence	 stock	page. catal.	groupe d'articles	prix en €
	BOX 4 éléments					
	Aluminium	blanc	44101004/1	✓	2402	94,16/pc.
	BOX 4 éléments					
	Aluminium	noir	44101004/2	✓	2402	94,16/pc.
	BOX 4 éléments					
	Aluminium	gris	44101004/4	✓	2402	94,16/pc.
	BOX 6 éléments					
	Aluminium	blanc	44101006/1	✓	2402	105,82/pc.
	BOX 6 éléments					
	Aluminium	noir	44101006/2	✓	2402	105,82/pc.
	BOX 6 éléments					
	Aluminium	gris	44101006/4	✓	2402	105,82/pc.



Connexions bureautiques: BOX

	type	référence	stock	page. catal.	groupe d'articles	prix en €
	CUBOBOX4 4 prises de courant Profilé en aluminium laqué en blanc et mécanismes blancs	34101003F1			2402	53,11/pc.
	CUBOBOX4 4 prises de courant Profilé en aluminium laqué en noir et mécanismes anthracite	34101003F3	✓		2402	53,11/pc.
	CUBOBOX4 3 prises de courant + 1 espace vide (45x45) Profilé en aluminium laqué en blanc et mécanismes blancs	32112001F1	✓		2402	51,97/pc.
	CUBOBOX4 3 prises de courant + 1 espace vide (45x45) Profilé en aluminium laqué en noir et mécanismes en anthracite	32112001F3	✓		2402	51,97/pc.
	CUBOBOX4 2 prises de courant + 2 espaces vides (45x45) Profilé en aluminium laqué en blanc et mécanismes blancs	32112002F1	✓		2402	47,25/pc.
	CUBOBOX4 2 prises de courant + 2 espaces vides (45x45) Profilé en aluminium laqué en noir et mécanismes en anthracite	32112002F3	✓		2402	47,25/pc.





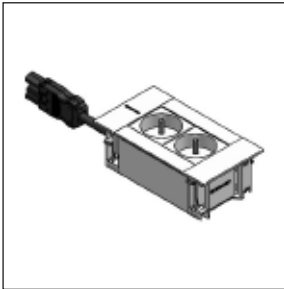
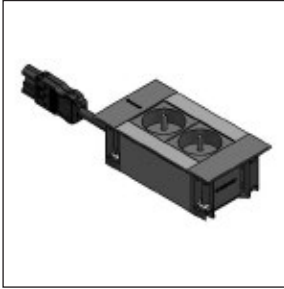
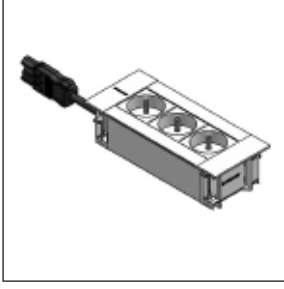
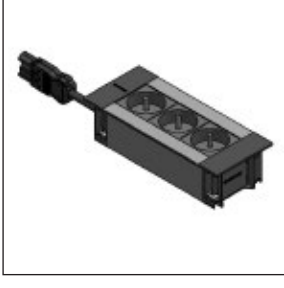
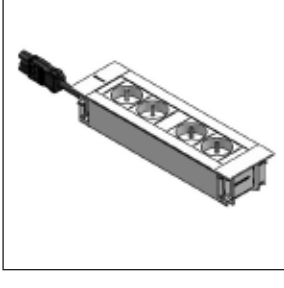

Connexions bureautiques: BOX

	type	référence	stock	page. catal.	groupe d'articles	prix en €
	CUBOBOX6 6 prises de courant Profilé en aluminium laqué en blanc et mécanismes blancs	34101005F1			2402	67,55/pc.
	CUBOBOX6 6 prises de courant Profilé en aluminium laqué en noir et mécanismes en anthracite	34101005F3			2402	67,55/pc.
	CUBOBOX6 3 prises de courant + 3 espaces vides (45x45) Profilé en aluminium laqué en blanc et mécanismes blancs	32112004F1			2402	58,21/pc.
	CUBOBOX6 3 prises de courant + 3 espaces vides (45x45) Profilé en aluminium laqué en noir et mécanismes en anthracite	32112004F3	✓		2402	58,21/pc.
	CUBOBOX6 4 prises de courant + 2 espaces vides (45x45) Profilé en aluminium laqué en blanc et mécanismes blancs	32112005F1			2402	61,52/pc.
	CUBOBOX6 4 prises de courant + 2 espaces vides (45x45) Profilé en aluminium laqué en noir et mécanismes en anthracite	32112005F3	✓		2402	61,52/pc.

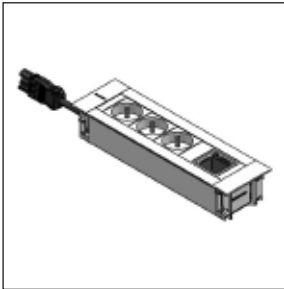

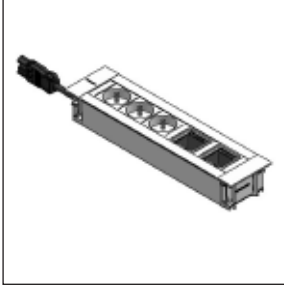

Connexions bureautiques: INTRO

	type	référence	 stock	page. catal.	groupe d'articles	prix en €
	INTRO L=144 mm 2 prises de courant Profilé en aluminium laqué en blanc et mécanismes blancs	66101001F1		2404		58,06/pc.
	INTRO L=144 mm 2 prises de courant Profilé en aluminium laqué en noir et mécanismes anthracite	66101001F3		2404		58,06/pc.
	INTRO L=189 mm 3 prises de courant Profilé en aluminium laqué en blanc et mécanismes blancs	66101002F1		2404		68,53/pc.
	INTRO L=189 mm 3 prises de courant Profilé en aluminium laqué en noir et mécanismes en anthracite	66101002F3		2404		68,53/pc.
	INTRO L=279 mm 4 prises de courant Profilé en aluminium laqué en blanc et mécanismes blancs	66101003F1		2404		83,59/pc.
	INTRO L=279 mm 4 prises de courant Profilé en aluminium laqué en noir et mécanismes en anthracite	66101003F3		2404		83,59/pc.

Connexions bureautiques: INTRO

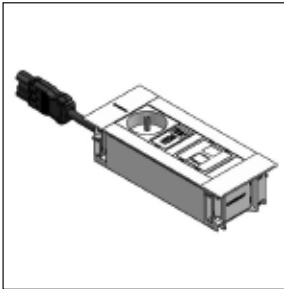
	type	référence	stock	page. catal.	groupe d'articles	prix en €
	INTRO L=279 mm					
	3 prises de courant + 1 espace vide (45x45)					
	Profilé en aluminium laqué en blanc et mécanismes blancs	66103003F1		2404		77,19/pc.
	INTRO L=279 mm					
	3 prises de courant + 1 espace vide (45x45)					
	Profilé en aluminium laqué en noir et mécanismes en anthracite	66103003F3		2404		77,19/pc.
	INTRO L=324 mm					
	3 prises de courant + 2 espaces vides (45x45)					
	Profilé en aluminium laqué en blanc et mécanismes blancs	66103004F1		2404		85,78/pc.
	INTRO L=324 mm					
	3 prises de courant + 2 espaces vides (45x45)					
	Profilé en aluminium laqué en noir et mécanismes en anthracite	66103004F3		2404		85,78/pc.
	INTRO L=369 mm					
	4 prises de courant + 2 espaces vides (45x45)					
	Profilé en aluminium laqué en blanc et mécanismes blancs	66103005F1		2404		93,37/pc.
	INTRO L=369 mm					
	4 prises de courant + 2 espaces vides (45x45)					
	Profilé en aluminium laqué en noir et mécanismes en anthracite	66103005F3		2404		93,37/pc.

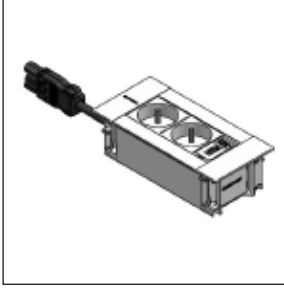
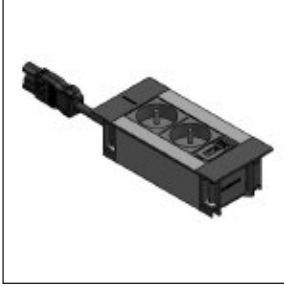
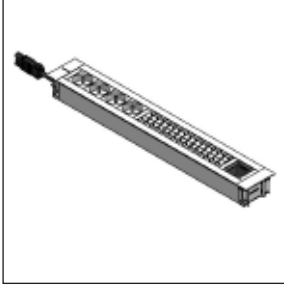



Connexions bureautiques: INTRO

	type	référence	📦 stock	page. catal.	groupe d'articles	prix en €
	INTRO L=189 mm					
	1 prises de courant + 1 x chargeur USB 5V/2A + 1 plaquette de montage 1 x RJ45 (connecteurs non inclus)	66103001F1		2404		70,42/pc.
	Profilé en aluminium laqué en blanc et mécanismes blancs					
	INTRO L=189 mm					
	1 prises de courant + 1 x chargeur USB 5V/2A + 1 plaquette de montage 1 x RJ45 (connecteurs non inclus)	66103001F3		2404		70,42/pc.
	Profilé en aluminium laqué en noir et mécanismes en anthracite					
	INTRO L=166 mm					
	2 prises de courant + 1 x chargeur USB 5V/2A	66103002F1		2404		87,15/pc.
	Profilé en aluminium laqué en blanc et mécanismes blancs					
	INTRO L=166 mm					
	2 prises de courant + 1 x chargeur USB 5V/2A	66103002F3		2404		87,15/pc.
	Profilé en aluminium laqué en noir et mécanismes en anthracite					
	INTRO L=549 mm					
	4 prises de courant + 1 ORGATECH	66108001F1		2404		135,34/pc.
	Profilé en aluminium laqué en blanc et mécanismes blancs					
	INTRO L=549 mm					
	4 prises de courant + 1 ORGATECH	66108001F3		2404		135,34/pc.
	Profilé en aluminium laqué en noir et mécanismes en anthracite					







Connexions bureautiques: PRISMA

	type	référence	 stock	page. catal.	groupe d'articles	prix en €
	PRISMA 3 prises de courant + 1 espace vide (45x45) Coffret blanc, profilé noir et mécanismes en anthracite	blanc 26103001F1			2413	158,71/pc.
	PRISMA 3 prises de courant + 1 espace vide (45x45) Coffret noir, profilé noir et mécanismes en anthracite	anthracite 26103001F3			2413	158,71/pc.
	PRISMA 2 prises de courant + 2 espaces vides (45x45) Coffret blanc, profilé noir et mécanismes en anthracite	blanc 26103002F1			2413	158,71/pc.
	PRISMA 2 prises de courant + 2 espaces vides (45x45) Coffret noir, profilé noir et mécanismes en anthracite	anthracite 26103002F3			2413	158,71/pc.
	PRISMA 3 prises de courant + 1 x chargeur USB 5V/2A + 1 plaquette de montage 1 x RJ45 (connecteurs non inclus) Coffret blanc, profilé noir et mécanismes en anthracite	blanc 26103003F1			2413	198,28/pc.
	PRISMA 3 prises de courant + 1 x chargeur USB 5V/2A + 1 plaquette de montage 1 x RJ45 (connecteurs non inclus) Coffret noir, profilé noir et mécanismes en anthracite	anthracite 26103003F3			2413	198,28/pc.

Connexions bureautiques: PRISMA

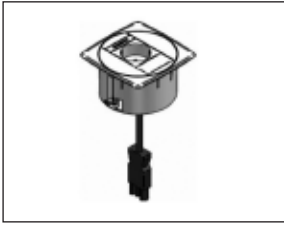
	type	référence	 stock	page. catal.	groupe d'articles	prix en €
	PRISMA SURFACE					
	3 prises de courant + 1 x chargeur USB 5V/2A + 1 plaquette de montage 1 x RJ45 (connecteurs non inclus)	blanc	26103006F1		2413	198,28/pc.
Coffret blanc, profilé noir et mécanismes en anthracite						
	PRISMA SURFACE					
	3 prises de courant + 1 x chargeur USB 5V/2A + 1 plaquette de montage 1 x RJ45 (connecteurs non inclus)	anthracite	26103006F3		2413	198,28/pc.
Coffret noir, profilé noir et mécanismes en anthracite						
	PRISMA SUPPORT					
	2 prises de courant + 1 x chargeur USB 5V/2A	blanc	26106005F1		2413	210,63/pc.
Coffret blanc, profilé noir et mécanismes en anthracite						
	PRISMA SUPPORT					
	2 prises de courant + 1 x chargeur USB 5V/2A	anthracite	26106005F3		2413	210,63/pc.
Coffret noir, profilé noir et mécanismes en anthracite						

Connexions bureautiques: UNIT

	type	référence	 stock	page. catal.	groupe d'articles	prix en €
	UNIT pour table comme passage de câbles					
	Matière synthétique					
	blanc	46100001/1			2411	24,95/pc.
	gris	46100001/3			2411	24,95/pc.
	UNIT pour table avec prise de courant et plaque aveugle 22,5 mm					
	Matière synthétique					
	blanc	46101001F1			2411	50,27/pc.
	gris	46101001F3			2411	50,27/pc.
	UNIT pour table avec prise de courant et plaque de montage pour RJ45					
	Matière synthétique					
	blanc	46102001F1			2411	56,75/pc.
	gris	46102001F3			2411	56,75/pc.
	UNIT pour table avec prise de courant et chargeur USB 5V/2A					
	Matière synthétique					
	blanc	46203002F1			2411	85,95/pc.
	gris	46203002F3			2411	85,95/pc.
	UNIT pour table avec prise de courant et chargeur USB 5V/2A, 1 USB charger type C					
	Matière synthétique					
	blanc	46203023F1			2411	110,82/pc.
	gris	46203023F3			2411	110,82/pc.
	UNIT pour sol rehaussé avec adaptateur pour ORGATECH					
	Matière synthétique					
	blanc	46100002/1			2411	25,75/pc.
	gris	46100002/3			2411	25,75/pc.

Connexions bureautiques: ORGATECH

	type	référence	📦 stock	page. catal.	groupe d'articles	prix en €
	ORGATECH L= 800 mm + 5 fixations					
	Matière synthétique					
	transparent	92114001	✓		2412	47,77/set
	blanc	92114001/1			2412	40,06/set
	gris	92114001/3			2412	40,06/set
	ORGATECH 2 anneaux + 2 fixations					
	Matière synthétique					
	transparent	92114007			2412	21,71/set
	ORGATECH embase + 4 anneaux					
	Acier laqué en noir					
	transparent	92114002			2412	18,91/pc.
	blanc	92114002/1			2412	18,07/pc.
	gris	92114002/3			2412	18,07/pc.
	ORGATECH dérivation (1 set = 5 dérivation)					
	Matière synthétique					
		92114003			2412	16,74/set
	ORGATECH fixation (1 set = 5 fixations)					
	Matière synthétique					
		92114004			2412	15,89/set
	Adaptateur femelle pour Orgatech (1 set = 5 pièces)					
	Matière synthétique					
	blanc	92114005/1			2412	10,89/set
	anthracite	92114005/3			2412	10,89/set
	Adaptateur mâle pour Orgatech (1 set = 5 pièces)					
	Matière synthétique					
	blanc	92114006/1			2412	10,89/set
	anthracite	92114006/3			2412	10,89/set



Connexions bureautiques: LUMEN

	type	référence	 stock	page. catal.	groupe d'articles	prix en €
	LUMEN	1 tube fluorescent 18W + 2 prises de courant + interrupteur				
	Aluminium	gris	74109001F3		2405	195,38/pc.
	LUMEN	1 tube fluorescent 18W + 2 prises de courant + interrupteur + entrée et sortie				
	Aluminium	gris	74109002F3		2405	205,13/pc.
	LUMEN	1 tube fluorescent 36 W + 2 prises de courant + interrupteur				
	Aluminium	gris	74109003F3		2405	236,25/pc.
	LUMEN 1	1 tube fluorescent 36 W + 2 prises de courant + interrupteur + entrée et sortie				
	Aluminium	gris	74109004F3		2405	245,87/pc.
	LUMEN	1 tube fluorescent 58W + 3 prises de courant + interrupteur				
	Aluminium	gris	74109005F3		2405	292,98/pc.
	LUMEN	1 tube fluorescent 58W + 3 prises de courant + interrupteur + entrée et sortie				
	Aluminium	gris	74109006F3		2405	299,57/pc.

Connexions bureautiques: plaques de montage

	type	référence	 stock	page. catal.	groupe d'articles	prix en €
	Plaque de montage (45 x 22.5): 1 x module VGA					
	blanc	91113029/1			2407	25,32/pc.
	anthracite	91113029/3			2407	25,32/pc.
	Plaque de montage (45 x 22.5): 1 x module stéréo					
	blanc	91113003/1			2407	11,44/pc.
	anthracite	91113003/3			2407	11,44/pc.
	Plaque de montage (45 x 45): 1 x XLR module 3 broches					
	blanc	91113004/1			2407	34,43/pc.
	anthracite	91113004/3			2407	34,43/pc.
	Plaque de montage (45 x 22.5): 1 x module BNC					
	blanc	91113005/1			2407	13,74/pc.
	anthracite	91113005/3			2407	13,74/pc.
	Plaque de montage (45 x 22.5): 1 x module RCA					
	blanc	91113006/1			2407	11,24/pc.
	anthracite	91113006/3			2407	11,24/pc.
	Plaque de montage (45 x 22.5): 1 x module F					
	blanc	91113007/1			2407	3,52/pc.
	anthracite	91113007/3			2407	3,52/pc.
	Plaque de montage (45 x 22.5): 1 x module USB 2.0 A/A					
	blanc	91113009/1		✓	2407	17,27/pc.
	anthracite	91113009/3		✓	2407	17,27/pc.

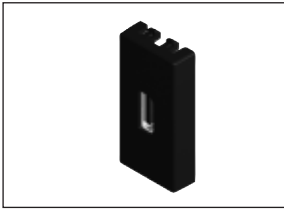
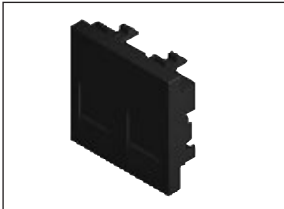
Connexions bureautiques: plaques de montage

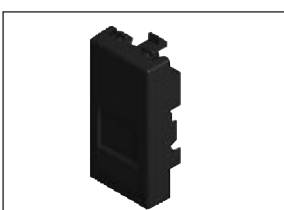
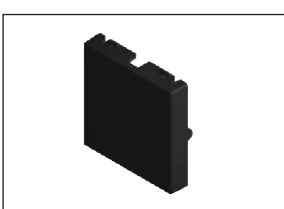
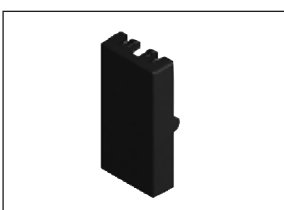
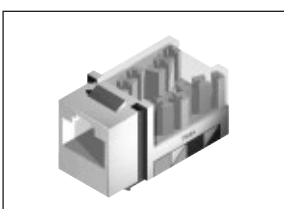
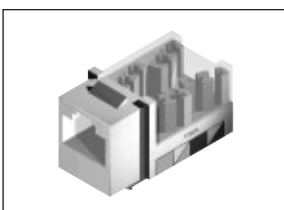
	type	référence	 stock	page. catal.	groupe d'articles	prix en €
	Plaque de montage (45 x 22.5): 1 x module HDMI					
	blanc	91113010/1	✓	2407		48,10/pc.
	anthracite	91113010/3	✓	2407		48,10/pc.
	Plaque de montage (45 x 45): 2 x module RJ45 (connecteurs non inclus)					
	blanc	91113011/1	✓	2407		5,61/pc.
	anthracite	91113011/3	✓	2407		5,61/pc.
	Plaque de montage (45 x 45): 1 x module RJ45 (connecteurs non inclus)					
	blanc	91113019/1		2407		5,18/pc.
	anthracite	91113019/3		2407		5,18/pc.
	Plaque de montage (45 x 22.5): 1 x module RJ 45 (connecteur non inclus)					
	blanc	91113012/1	✓	2407		4,54/pc.
	anthracite	91113012/3	✓	2407		4,54/pc.
	Plaque de montage (45 x 45): aveugle					
	blanc	91113013/1	✓	2407		1,58/pc.
	anthracite	91113013/3	✓	2407		1,58/pc.
	Plaque de montage (45 x 22.5): aveugle					
	blanc	91113014/1	✓	2407		1,28/pc.
	anthracite	91113014/3	✓	2407		1,28/pc.
	Connecteur CAT5e femelle					
	RJ45	91112001	✓	2407		8,76/pc.
	Connecteur CAT6 femelle					
	RJ45	91112002	✓	2407		11,44/pc.

Connexions bureautiques: accessoires

	type	référence	stock	page. catal.	groupe d'articles	prix en €
	Connecteur CAT5e femelle/femelle					
	RJ45	91112003	✓		2407	5,03/pc.
	Connecteur CAT6 femelle/femelle					
	RJ45	91112004	✓		2407	5,66/pc.
	Connecteur en T GST 18T					
	noir	91111001/2			2407	4,75/pc.
	Connecteur GST18 mâle, 3 pôles					
	noir	91111002/2			2407	2,59/pc.
	rouge	91111002/6			2407	2,76/pc.
	Connecteur GST18 femelle, 3 pôles					
	noir	91111003/2			2407	2,59/pc.
	rouge	91111003/6			2407	2,76/pc.
	Connexion intermédiaire GST 18					
	noir	91111005/2			2407	4,25/pc.
	Distributeur in: 1 GST18, mâle noir; out: 6GST18, femelle noir					
	Aluminium					
	noir	33105001			2407	87,81/pc.
	Distributeur in: 1 GST18, mâle noir et 1 GST18 mâle rouge; out: 6 GST18, femelle noir et 6 GST18 femelle rouge					
	Aluminium					
	noir/rouge	33105002			2407	153,26/pc.

Connexions bureautiques: accessoires

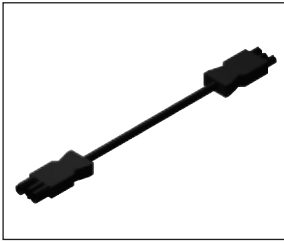
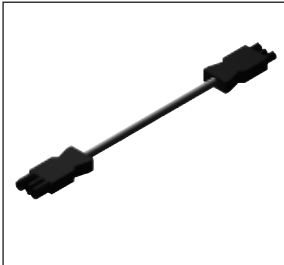
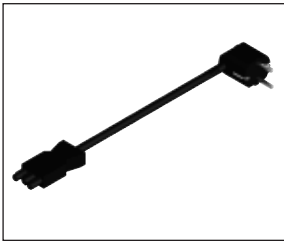
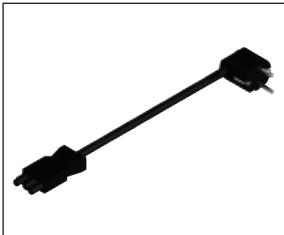
	type	référence	 stock	page. catal.	groupe d'articles	prix en €
	Câble de rallonge GST18 3-polaire mâle / GST18 3-polaire femelle; câble HO5VV-F 3G2,5					
	1m noir	91110008/2		2407		19,16/pc.
	1m rouge	91110008/6		2407		24,51/pc.
	2m noir	91110009/2		2407		21,77/pc.
	2m rouge	91110009/6		2407		26,90/pc.
	3m noir	91110010/2		2407		26,45/pc.
3m rouge	91110010/6		2407		32,92/pc.	
	Câble de rallonge GST18 3-polaire mâle / GST18 3-polaire femelle, câble exempt d'halogènes JZ500 HMH 3G2,5					
	1m noir	91110020/2		2407		22,29/pc.
	1m rouge	91110020/6		2407		27,57/pc.
	2m noir	91110012/2		2407		26,22/pc.
	2m rouge	91110012/6		2407		32,67/pc.
	3m noir	91110014/2		2407		32,60/pc.
3m rouge	91110014/6		2407		34,91/pc.	
	Câble de raccordement GST 18 3-polaire femelle ; câble HO5VV-F 3G2,5 ; fiche					
	2m noir	91110006F2	✓	2407		19,78/pc.
	2m rouge	91110006F6		2407		25,04/pc.
	3m noir	91110007F2	✓	2407		24,97/pc.
	3m rouge	91110007F6		2407		31,27/pc.
	Câble de raccordement GST 18 3-polaire femelle ; câble exempt d'halogènes JZ-500 HMH 3G2,5 ; fiche					
	2m noir	91110016F2		2407		26,45/pc.
	2m rouge	91110016F6		2407		32,39/pc.
	3m noir	91110018F2		2407		31,69/pc.
	3m rouge	91110018F6		2407		39,57/pc.

Index

référence	prix en €	page	référence	prix en €	page	référence	prix en €	page	référence	prix en €	page
40611	2,45/pc.	54	705397	34,45/pc.	18	714165	12,55/pc.	10	716208	723,28/pc.	23
40616	3,28/pc.	54	706415	13,13/set	26	714168	116,40/pc.	21	716209	364,14/pc.	23
40631	7,09/pc.	54	707511	9,70/pc.	10	714179	30,31/pc.	25	716210	365,58/pc.	23
70510	2,80/pc.	40	707609	68,58/pc.	24	714198	207,93/m	7	716212	374,18/pc.	23
80100	1,61/pc.	43	707748	104,38/pc.	21	714200	212,68/m	7	716213	387,10/pc.	23
80200	4,37/pc.	55	708001	21,43/pc.	25	714201	226,62/m	7	716214	395,73/pc.	23
80201	8,42/pc.	55	709017	15,97/pc.	19	714202	217,43/m	7	716215	407,22/pc.	23
80202	3,59/pc.	55	709018	14,41/pc.	19	714203	227,96/m	7	716216	573,85/pc.	23
80602	2,77/pc.	54	709019	3,50/pc.	20	714227	76,44/pc.	24	716217	586,27/pc.	23
80603	4,49/pc.	54	709020	6,37/pc.	21	714700	71,10/pc.	9	716218	637,07/pc.	23
80604	5,49/pc.	54	709021	5,82/pc.	21	715675	15,46/pc.	16	716220	688,29/pc.	23
80605	9,17/pc.	54	709031	168,56/m	15	715723	68,89/pc.	13	716221	718,55/pc.	23
80606	11,62/pc.	54	709050	2,55/pc.	30	715723	68,89/pc.	54	716222	749,42/pc.	23
80607	18,03/pc.	54	709051	2,55/pc.	30	715724	83,79/pc.	13	716223	802,62/pc.	23
80610	11,92/pc.	54	709052	2,82/pc.	30	715724	83,79/pc.	54	716224	1125,92/pc.	23
81501	3,28/pc.	55	709053	2,82/pc.	30	715725	106,12/pc.	13	716241	423,75/pc.	25
81503	4,00/pc.	55	709054	2,82/pc.	30	715725	106,12/pc.	54	716243	435,96/pc.	25
81504	1,71/pc.	44	709055	3,45/pc.	30	715726	138,52/pc.	13	716244	446,71/pc.	25
81512	3,81/pc.	44	709056	3,45/pc.	30	715726	138,52/pc.	54	716245	466,83/pc.	25
81522	4,63/pc.	44	709057	3,45/pc.	30	715727	174,04/pc.	13	716246	468,97/pc.	25
81532	5,29/pc.	44	709058	3,45/pc.	30	715727	174,04/pc.	54	716247	792,17/pc.	25
81542	6,09/pc.	44	709795	89,96/m	14	715728	288,19/pc.	13	716248	625,27/pc.	25
81550	7,22/pc.	44	709798	119,59/m	15	715728	288,19/pc.	54	716250	674,11/pc.	25
81552	7,38/pc.	44	709799	301,46/pc.	13	715735	1,63/pc.	34	716251	678,21/pc.	25
81562	8,73/pc.	44	709801	19,61/pc.	17	715736	2,12/pc.	34	716253	796,31/pc.	25
81572	9,49/pc.	44	711205	27,54/pc.	27	715879	20,12/m	14	716254	940,38/pc.	25
81582	11,20/pc.	44	712015	113,17/m	7	716066	211,97/pc.	22	716255	596,10/pc.	26
81710	15,46/pc.	53	712017	116,15/m	7	716067	211,97/pc.	22	716257	610,46/pc.	26
81712	11,22/pc.	53	712018	123,05/m	7	716069	224,88/pc.	22	716258	620,53/pc.	26
81715	15,80/pc.	53	712019	118,67/m	7	716070	227,13/pc.	22	716259	637,73/pc.	26
81720	16,97/pc.	53	712020	124,45/m	7	716071	242,90/pc.	22	716260	638,47/pc.	26
81722	13,49/pc.	53	712465	207,53/pc.	9	716072	261,61/pc.	22	716261	1041,39/pc.	26
81730	22,98/pc.	53	712639	15,36/pc.	32	716073	530,64/pc.	22	716262	1033,70/pc.	26
81731	11,95/pc.	53	712640	16,64/pc.	32	716074	263,76/pc.	22	716264	1114,38/pc.	26
81732	17,46/pc.	53	712642	16,91/pc.	32	716075	290,21/pc.	22	716265	1143,44/pc.	26
81733	26,15/pc.	53	712643	19,87/pc.	32	716077	320,32/pc.	22	716267	1245,46/pc.	26
81740	27,45/pc.	53	712644	23,93/pc.	32	716078	343,19/pc.	22	716268	1464,82/pc.	26
81742	23,59/pc.	53	712645	25,62/pc.	32	716079	388,27/pc.	22	716276	112,50/pc.	13
81752	30,81/pc.	53	713153	11,89/pc.	16	716080	390,20/pc.	22	716277	135,63/pc.	13
81762	39,29/pc.	53	713173	37,47/pc.	17	716081	584,91/pc.	22	716278	165,70/pc.	13
81977	0,08/pc.	56	713177	18,76/pc.	17	716179	314,54/pc.	22	716279	228,01/pc.	13
84400	1,50/pc.	53	713178	19,80/pc.	17	716180	336,56/pc.	22	716280	319,10/pc.	13
84901	1,83/pc.	55	713203	16,68/pc.	20	716182	360,92/pc.	22	716281	512,70/pc.	13
86510	13,45/pc.	53	713204	16,01/pc.	20	716183	392,57/pc.	22	716282	550,50/pc.	13
86520	15,80/pc.	53	713207	23,67/pc.	20	716184	430,37/pc.	22	716283	63,42/pc.	12
86530	17,84/pc.	53	713208	22,51/pc.	20	716185	436,62/pc.	22	716284	66,55/pc.	12
86540	19,31/pc.	53	713684	0,81/m	29	716186	350,82/pc.	22	716285	72,58/pc.	12
88520	1,25/pc.	44	713685	0,81/m	29	716187	399,29/pc.	22	716286	79,15/pc.	12
88540	0,38/pc.	45	713686	2,41/m	29	716189	450,76/pc.	22	716287	90,96/pc.	12
88550	1,05/pc.	44	713687	2,69/m	29	716190	515,67/pc.	22	716293	30,93/pc.	15
88701	6,39/m	43	713694	1,04/pc.	35	716191	663,07/pc.	22	716294	18,36/pc.	16
88705	0,51/pc.	43	714021	63,05/pc.	9	716192	673,16/pc.	22	716295	18,20/pc.	16
88712	5,97/pc.	43	714022	80,43/pc.	9	716193	233,41/pc.	23	716302	48,15/pc.	17
88722	6,32/pc.	43	714023	104,52/pc.	9	716194	236,99/pc.	23	716303	24,62/pc.	17
88732	6,82/pc.	43	714024	240,80/pc.	9	716196	245,62/pc.	23	716304	25,83/pc.	17
88742	7,21/pc.	43	714029	28,16/pc.	10	716197	261,41/pc.	23	716306	48,16/m	14
88752	8,24/pc.	43	714058	93,46/m	7	716198	266,46/pc.	23	716307	127,94/m	14
89077	0,15/pc.	56	714059	93,46/m	7	716199	282,26/pc.	23	716308	154,66/m	15
89177	0,23/pc.	56	714061	97,02/m	7	716200	649,24/pc.	23	716309	33,47/m	14
705093	30,70/m	14	714062	101,52/m	7	716201	532,70/pc.	23	716389	229,57/pc.	25
705304	10,48/pc.	18	714063	108,94/m	7	716202	403,34/pc.	23	716390	233,85/pc.	25
705392	23,59/pc.	18	714064	113,67/m	7	716204	442,22/pc.	23	716391	235,84/pc.	25
705394	27,04/pc.	18	714066	16,89/pc.	18	716205	466,43/pc.	23	716392	236,86/pc.	25
705395	29,03/pc.	18	714067	17,80/pc.	19	716206	520,62/pc.	23	716393	270,48/pc.	25
705396	33,90/pc.	18	714085	18,39/pc.	19	716207	521,69/pc.	23	716395	245,30/pc.	25

Index

référence	prix en €	page	référence	prix en €	page	référence	prix en €	page	référence	prix en €	page
716396	252,51/pc.	25	718190	316,56/pc.	24	720525	154,66/m	15	723438	34,99/pc.	8
716397	267,86/pc.	25	718191	441,45/pc.	24	720526	217,39/m	15	723439	36,74/pc.	8
716398	290,86/pc.	25	718243	16,49/pc.	16	720527	196,60/pc.	16	723440	43,48/pc.	8
716399	302,53/pc.	25	718249	133,65/pc.	13	720528	218,14/pc.	16	723441	43,48/pc.	8
716400	292,28/m	7	718250	180,75/pc.	13	720529	38,91/pc.	17	723442	44,20/pc.	8
716401	390,96/m	7	718251	223,90/pc.	13	720530	185,38/pc.	18	723443	51,88/pc.	8
716640	4,71/pc.	27	718253	190,92/pc.	15	720531	28,52/pc.	18	723444	53,36/pc.	8
716792	4,80/m	11	718409	25,14/pc.	19	720536	138,32/pc.	17	723445	70,31/pc.	8
716792	4,80/m	129	718410	40,31/pc.	19	720761	17,49/pc.	11	723446	90,96/pc.	8
716793	4,80/m	11	718473	1,19/pc.	40	720762	18,25/pc.	11	723447	94,94/pc.	8
716794	6,52/pc.	35	718484	216,71/pc.	13	720763	19,98/pc.	11	723450	58,14/pc.	16
716795	8,61/pc.	35	718485	285,93/pc.	13	720764	23,09/pc.	11	723451	58,76/pc.	16
716796	9,34/pc.	35	718486	414,90/pc.	13	720765	30,81/pc.	11	723925	69,80/m	11
716821	5,04/pc.	55	718487	27,20/pc.	16	720766	35,51/pc.	11	723926	75,41/m	11
716824	5,64/pc.	28	718488	249,79/pc.	15	720815	93,31/pc.	26	723938	0,62/pc.	12
717001	24,63/pc.	10	718562	47,12/m	6	720816	105,37/pc.	26	723938	0,62/pc.	129
717191	15,95/pc.	12	718563	47,12/m	6	720824	25,19/pc.	20	723939	2,55/pc.	12
717192	17,84/pc.	12	718564	49,11/m	6	721101	10,38/pc.	15	724806	4,98/pc.	12
717193	18,75/pc.	12	718565	51,28/m	6	721102	11,71/m	13	724806	4,98/pc.	56
717194	26,20/pc.	12	718566	55,06/m	6	721105	10,70/pc.	20	724807	38,90/pc.	12
717195	30,81/pc.	12	718567	57,34/m	6	721106	12,33/pc.	20	725065	11,70/m	29
717196	22,18/pc.	12	718568	175,15/m	6	721114	71,82/pc.	21	725066	12,76/m	29
717196	22,18/pc.	54	718572	20,90/m	6	721115	6,46/pc.	18	725067	15,43/m	29
717196	22,18/pc.	128	718573	25,75/m	6	721119	12,66/pc.	17	725083	3,57/pc.	56
717197	25,34/pc.	12	718574	29,29/m	6	721122	16,54/pc.	19	725096	67,43/pc.	23
717197	25,34/pc.	54	718575	34,08/m	6	721862	43,90/pc.	11	725350	40,75/m	6
717197	25,34/pc.	128	718576	37,57/m	6	721863	44,39/pc.	11	725350	40,75/m	128
717198	28,77/pc.	12	718591	75,38/m	6	721864	50,16/pc.	11	725351	40,75/m	6
717198	28,77/pc.	54	718592	75,38/m	6	721865	51,95/pc.	11	725351	40,75/m	128
717198	28,77/pc.	128	718593	78,60/m	6	721866	57,33/pc.	11	725352	42,14/m	6
717199	33,02/pc.	12	718594	82,06/m	6	721867	59,95/pc.	11	725352	42,14/m	128
717199	33,02/pc.	54	718595	88,12/m	6	721869	13,05/pc.	11	725353	43,90/m	6
717199	33,02/pc.	128	718596	92,07/m	6	721870	17,79/pc.	11	725353	43,90/m	128
717200	37,93/pc.	12	718597	280,22/m	6	721871	19,06/pc.	11	725354	46,20/m	6
717200	37,93/pc.	54	718618	25,47/pc.	27	721872	25,27/pc.	11	725355	48,63/m	6
717201	66,78/pc.	12	718624	50,84/pc.	9	721873	27,66/pc.	11	725356	114,39/m	6
717202	72,44/pc.	12	718625	55,04/pc.	9	721945	28,09/pc.	20	725357	6,98/pc.	13
717203	82,27/pc.	12	718626	63,25/pc.	9	721960	104,60/m	6	725358	7,90/pc.	13
717204	98,23/pc.	12	718627	71,63/pc.	9	721961	459,61/pc.	22	725359	9,33/pc.	13
717205	109,32/pc.	12	718628	79,94/pc.	9	721962	655,89/pc.	23	725360	12,13/pc.	13
717618	21,10/pc.	17	718632	3,99/pc.	35	721963	1017,23/pc.	23	725361	15,82/pc.	13
717637	109,16/pc.	31	718640	15,02/pc.	15	721964	354,08/pc.	24	725362	10,85/pc.	16
717640	28,14/pc.	17	718643	33,90/pc.	26	723057	621,89/pc.	22	725363	15,77/pc.	20
717641	37,08/pc.	17	718644	37,29/pc.	26	723061	156,09/pc.	22	725557	69,52/pc.	12
717642	55,24/pc.	17	718660	463,53/pc.	31	723062	165,65/pc.	22	725558	77,12/pc.	12
717643	45,48/pc.	17	718718	343,43/pc.	13	723063	168,63/pc.	22	725559	100,86/pc.	12
717644	45,87/pc.	17	718719	410,60/pc.	13	723064	197,93/pc.	22	725560	108,09/pc.	12
717645	64,64/pc.	17	718720	542,30/pc.	13	723065	205,39/pc.	22	725561	131,80/pc.	12
717982	113,17/m	7	718721	605,85/pc.	13	723212	42,81/pc.	23	725562	106,82/pc.	12
717983	116,15/m	7	718793	97,86/pc.	9	723260	853,99/pc.	22	725563	124,56/pc.	12
717984	118,67/m	7	718808	119,59/m	15	723390	193,21/m	7	725564	157,73/pc.	12
717985	123,05/m	7	718835	11,50/pc.	28	723391	197,73/m	7	725565	208,04/pc.	12
717986	124,45/m	7	718849	35,74/pc.	17	723392	201,62/m	7	725566	268,95/pc.	12
718176	243,51/pc.	24	718850	144,41/pc.	16	723393	209,72/m	7	725567	433,24/pc.	13
718177	254,18/pc.	24	718851	159,74/pc.	16	723394	210,16/m	7	725568	534,34/pc.	13
718179	260,46/pc.	24	718903	166,24/pc.	18	723432	14,02/pc.	8	725569	643,31/pc.	13
718180	275,46/pc.	24	718904	17,01/pc.	18	723433	14,18/pc.	8	725570	838,26/pc.	13
718181	279,65/pc.	24	720252	sur demande	25	723434	14,54/pc.	8	725571	1042,41/pc.	13
718182	289,31/pc.	24	720266	sur demande	26	723434	14,54/pc.	128	725572	1470,41/pc.	13
718183	375,44/pc.	24	720517	236,86/pc.	25	723434	14,54/pc.	128	725573	50,38/pc.	15
718184	271,55/pc.	24	720518	279,23/pc.	25	723435	16,43/pc.	8	725574	20,63/pc.	14
718185	283,45/pc.	24	720521	670,20/pc.	13	723436	16,74/pc.	8	725575	27,50/pc.	14
718187	290,46/pc.	24	720522	797,70/pc.	13	723436	16,74/pc.	128	725576	34,38/pc.	14
718188	307,19/pc.	24	720523	989,19/pc.	13	723437	26,46/pc.	8	725577	49,04/pc.	14
718189	313,00/pc.	24	720524	1095,08/pc.	13	723437	26,46/pc.	128	725578	68,74/pc.	14

Index

référence	prix en €	page	référence	prix en €	page	référence	prix en €	page	référence	prix en €	page
725579	68,74/m	14	727377	340,69/m	7	731793	49,56/pc.	17	734495	40,67/m	6
725582	8,87/pc.	35	727378	356,69/m	7	731837	145,62/pc.	27	734496	43,54/m	6
725590	57,78/m	29	727379	360,33/m	7	731911	205,32/pc.	27	734497	47,26/m	6
725591	89,76/m	29	727380	367,37/m	7	731914	316,24/pc.	27	734498	49,88/m	6
725592	145,37/m	29	727381	374,46/m	7	731994	4,36/pc.	20	734713	83,14/pc.	19
725593	63,70/pc.	28	727382	202,67/m	7	732151	29,33/m	21	734744	6,47/pc.	35
725594	93,42/pc.	28	727383	205,50/m	7	732177	9,91/pc.	16	734864	6,39/pc.	35
725618	93,42/pc.	9	727384	211,17/m	7	732216	13,70/m	32	734983	6,30/pc.	35
725619	94,86/pc.	9	727385	222,49/m	7	732217	16,84/m	32	734986	69,61/pc.	35
725620	97,80/pc.	9	727386	231,93/m	7	732218	22,37/m	32	735433	75,02/pc.	19
725621	113,98/pc.	9	727387	243,26/m	7	732219	32,73/m	32	735434	83,96/pc.	19
725622	194,43/pc.	9	727582	14,34/pc.	11	732220	38,03/m	32	735435	92,40/pc.	19
725623	244,16/pc.	9	727583	16,63/pc.	11	732221	52,39/m	32	735436	103,66/pc.	19
725624	265,21/pc.	9	727584	19,65/pc.	11	732222	129,69/m	32	735446	3,50/pc.	20
725625	290,79/pc.	9	727585	24,57/pc.	11	732264	33,99/m	32	735977	12,02/m	41
725636	54,85/pc.	17	727586	27,68/pc.	11	732265	35,06/m	32	735978	14,64/m	41
725751	36,08/pc.	18	727777	38,89/pc.	8	732266	44,51/m	32	735979	19,23/m	41
725760	51,53/pc.	19	727778	42,47/pc.	8	732267	57,14/m	32	735980	23,79/m	41
725763	10,67/pc.	9	727779	47,36/pc.	8	732268	58,19/m	32	735981	33,24/m	41
725774	51,53/pc.	20	727780	52,58/pc.	8	732269	69,77/m	32	735982	42,30/m	41
725775	56,77/pc.	20	727781	54,06/pc.	8	732270	154,23/m	32	735988	8,88/m	40
725776	44,47/pc.	27	727782	147,59/pc.	8	732291	108,98/m	32	735989	11,60/m	40
725777	53,42/pc.	27	727783	167,10/pc.	8	732292	139,82/m	32	735990	14,33/m	40
725785	12,60/pc.	28	727784	170,99/pc.	8	732293	175,33/m	32	735991	17,30/m	40
726433	96,89/pc.	11	727785	172,80/pc.	8	732294	260,61/m	32	735992	23,09/m	40
726434	99,50/pc.	11	728033	167,35/m	6	732295	310,09/m	32	735993	29,92/m	40
726435	148,62/pc.	11	728034	485,85/pc.	24	732296	322,24/m	32	735998	463,53/pc.	31
726436	201,76/pc.	11	728043	509,50/pc.	22	732297	812,16/m	32	736440	179,09/pc.	30
726437	314,17/pc.	11	728052	855,68/pc.	22	732322	146,87/pc.	33	736441	182,71/pc.	30
726438	339,91/pc.	11	728053	1166,01/pc.	22	732323	162,46/pc.	33	736442	184,98/pc.	30
726484	102,09/pc.	17	728586	8,95/pc.	33	732324	188,00/pc.	33	736443	187,44/pc.	30
726485	106,82/pc.	17	728595	196,92/m	14	732325	229,57/pc.	33	736444	199,51/pc.	30
726668	1,05/pc.	20	728596	64,31/pc.	35	732326	273,62/pc.	33	736445	203,17/pc.	30
727125	71,70/pc.	8	728598	68,25/pc.	35	732327	296,35/pc.	33	736446	206,78/pc.	30
727126	75,56/pc.	8	728642	13,54/pc.	30	732328	386,35/pc.	33	736447	227,12/pc.	30
727127	83,26/pc.	8	728643	25,87/pc.	30	732345	164,48/pc.	34	736448	230,76/pc.	30
727128	89,29/pc.	8	728651	43,95/pc.	29	732346	200,24/pc.	34	736449	234,30/pc.	30
727195	105,32/pc.	23	728652	49,13/pc.	29	732347	218,07/pc.	34	736450	267,89/pc.	30
727197	119,09/pc.	21	728653	30,26/pc.	29	732348	233,95/pc.	34	736451	271,55/pc.	30
727340	94,31/pc.	21	728654	32,68/pc.	29	732349	271,48/pc.	34	736452	275,15/pc.	30
727346	562,22/pc.	22	728767	38,65/pc.	26	732350	300,83/pc.	34	736453	306,50/pc.	30
727347	590,32/pc.	22	728883	8,46/pc.	55	732351	454,17/pc.	34	736454	310,04/pc.	30
727348	663,48/pc.	22	729045	65,30/pc.	10	732475	251,08/pc.	29	736455	312,42/pc.	30
727349	742,04/pc.	22	729217	6,44/pc.	33	732476	260,19/pc.	29	736456	27,70/pc.	31
727350	787,11/pc.	22	730188	8,40/pc.	33	732477	296,35/pc.	29	736609	32,70/m	40
727351	843,43/pc.	22	730190	18,06/pc.	33	732478	316,66/pc.	29	736610	40,74/m	40
727352	1413,94/pc.	22	730192	282,78/pc.	29	732479	323,48/pc.	29	736619	47,22/m	41
727353	719,65/pc.	22	730193	294,07/pc.	29	732481	966,71/pc.	29	736620	57,74/m	41
727354	792,63/pc.	22	730194	327,99/pc.	29	732482	1224,43/pc.	29	737198	10,54/pc.	31
727355	916,23/pc.	22	730195	361,97/pc.	29	732483	1272,87/pc.	29	737704	29,40/pc.	31
727356	1316,49/pc.	22	730196	401,57/pc.	29	732484	1742,09/pc.	29	737705	29,40/pc.	31
727357	914,43/pc.	22	730245	25,79/pc.	27	732485	1772,32/pc.	29	737706	29,40/pc.	31
727358	809,50/pc.	23	731717	26,08/m	14	732983	21,71/pc.	28	737707	29,40/pc.	31
727359	730,93/pc.	23	731719	30,70/m	14	733258	1,43/pc.	41	737708	29,40/pc.	31
727360	820,82/pc.	23	731721	26,08/m	14	733487	11,58/pc.	16	739713	126,64/pc.	31
727361	921,98/pc.	23	731724	48,24/m	14	734171	44,84/pc.	19	760200	8,25/m	44
727362	1051,37/pc.	23	731727	196,92/m	14	734172	54,96/pc.	19	762400	2,07/pc.	44
727363	1265,00/pc.	23	731745	27,66/pc.	27	734173	67,43/pc.	19	768001	58,40/m	7
727370	528,32/pc.	24	731746	30,74/pc.	27	734174	77,75/pc.	19	768002	58,40/m	7
727371	472,26/pc.	24	731747	18,43/pc.	28	734488	20,90/m	6	768004	60,64/m	7
727372	566,71/pc.	24	731748	17,01/m	29	734489	25,75/m	6	768005	63,44/m	7
727373	595,90/pc.	24	731749	22,85/m	29	734490	29,29/m	6	768006	68,09/m	7
727374	627,42/pc.	24	731750	32,77/m	29	734491	34,08/m	6	768007	71,04/m	7
727375	640,93/pc.	24	731791	17,01/pc.	17	734492	37,57/m	6	768063	42,28/m	14
727376	335,52/m	7	731792	33,69/pc.	17	734494	38,93/m	6	768733	13,71/pc.	21

Index

référence	prix en €	page	référence	prix en €	page	référence	prix en €	page	référence	prix en €	page
768738	18,76/pc.	10	783376	sur demande	22	788651	119,87/pc.	34	795317	8,98/pc.	54
780186	430,92/pc.	31	783377	sur demande	22	788652	1135,97/pc.	34	795318	13,15/pc.	8
780187	4813,08/set	31	783460	21,50/pc.	28	788653	2361,63/pc.	34	795318	13,15/pc.	54
780452	38,30/pc.	32	783461	27,66/pc.	28	789875	2,79/pc.	21	795319	14,93/pc.	8
780453	40,08/pc.	32	784066	432,86/m	8	789876	7,22/pc.	21	795319	14,93/pc.	54
780454	43,70/pc.	32	784067	450,66/m	8	790906	74,30/pc.	23	795320	20,34/pc.	8
780455	45,56/pc.	32	784068	474,88/m	8	791063	20,21/pc.	11	795320	20,34/pc.	54
780456	49,20/pc.	32	784069	493,83/m	8	791064	20,66/pc.	11	795321	22,96/pc.	8
780457	51,02/pc.	32	784070	509,37/m	8	791065	21,10/pc.	11	795321	22,96/pc.	54
780874	142,45/pc.	19	784072	934,97/m	8	791066	21,79/pc.	11	795322	18,65/pc.	8
781099	74,27/m	6	784073	41,79/pc.	40	791067	22,61/pc.	11	795322	18,65/pc.	54
781433	116,73/pc.	33	784074	44,19/pc.	40	791068	23,03/pc.	11	795323	21,18/pc.	8
781434	146,46/pc.	33	784075	46,57/pc.	40	791092	3,99/pc.	11	795323	21,18/pc.	54
781435	164,80/pc.	33	784076	52,54/pc.	40	791199	16,75/pc.	18	795363	50,27/pc.	54
781436	204,94/pc.	33	784077	60,31/pc.	40	791200	41,06/pc.	18	795364	54,69/pc.	54
781437	217,67/pc.	33	784078	67,46/pc.	40	791350	48,66/pc.	24	795598	6,66/pc.	33
781438	247,92/pc.	33	784079	76,42/pc.	40	791401	81,74/pc.	24	795600	4,35/pc.	30
781439	455,12/pc.	33	784080	96,14/pc.	40	791412	4,38/pc.	8	795601	4,70/pc.	30
781440	144,21/pc.	34	784081	46,57/pc.	41	791412	4,38/pc.	54	795602	4,76/pc.	30
781441	169,97/pc.	34	784082	48,95/pc.	41	791413	6,10/pc.	8	795603	5,13/pc.	30
781442	204,38/pc.	34	784083	51,94/pc.	41	791413	6,10/pc.	54	795604	5,34/pc.	30
781443	248,13/pc.	34	784084	60,90/pc.	41	791414	7,41/pc.	8	795605	5,53/pc.	30
781444	300,66/pc.	34	784085	72,89/pc.	41	791414	7,41/pc.	54	795606	5,77/pc.	30
781445	325,79/pc.	34	784086	77,02/pc.	41	791415	11,99/pc.	8	795607	5,83/pc.	30
781446	844,87/pc.	34	784087	92,55/pc.	41	791415	11,99/pc.	54	795608	6,87/pc.	30
781654	sur demande	34	784088	112,85/pc.	41	791416	20,59/pc.	54	795609	4,70/pc.	30
781751	151,15/pc.	33	784089	45,98/pc.	40	791417	25,57/pc.	54	795610	4,76/pc.	30
781752	173,65/pc.	33	784090	50,14/pc.	40	791418	29,28/pc.	54	795611	5,34/pc.	30
781753	218,42/pc.	33	784091	51,94/pc.	40	791419	45,33/pc.	54	795612	5,39/pc.	30
781754	287,85/pc.	33	784092	59,13/pc.	40	792873	98,58/pc.	24	795613	5,83/pc.	30
781755	327,21/pc.	33	784093	67,46/pc.	40	792875	sur demande	24	795614	6,23/pc.	30
781756	383,49/pc.	33	784094	75,23/pc.	40	792877	43,33/pc.	25	795615	8,20/pc.	30
781757	784,95/pc.	33	784095	83,59/pc.	40	792880	418,02/pc.	25	795616	8,47/pc.	30
781765	203,04/pc.	34	784096	97,92/pc.	40	792881	419,52/pc.	25	8010109	1,61/pc.	43
781766	239,08/pc.	34	784097	50,75/pc.	41	792882	420,97/pc.	25	8040000	62,22/pc.	45
781767	351,13/pc.	34	784098	54,33/pc.	41	792883	422,91/pc.	25	08050000	4,87/m	56
781768	355,77/pc.	34	784099	56,72/pc.	41	792884	424,58/pc.	25	08050100	4,87/m	56
781769	462,17/pc.	34	784100	63,90/pc.	41	792886	sur demande	25	08050200	2,71/m	56
781770	505,99/pc.	34	784101	74,04/pc.	41	792888	167,12/pc.	26	08051000	4,10/m	56
781771	1120,04/pc.	34	784102	79,41/pc.	41	792893	15,42/pc.	10	08051020	16,09/m	56
781793	711,31/pc.	33	784103	90,75/pc.	41	792903	1256,28/pc.	25	8090109	6,72/pc.	45
781794	903,04/pc.	33	784104	115,23/pc.	41	792904	1315,40/pc.	25	8101009	4,37/pc.	53
781796	676,17/pc.	34	786768	66,93/pc.	10	792905	1481,12/pc.	25	8112009	5,29/pc.	53
781802	366,34/pc.	33	786768	66,93/pc.	128	792906	1631,02/pc.	25	8123009	7,52/pc.	53
781803	511,36/pc.	34	787276	110,14/pc.	12	792907	1678,91/pc.	25	8134009	8,51/pc.	53
782128	482,07/m	7	787276	110,14/pc.	54	792909	sur demande	25	8135009	11,22/pc.	53
782129	553,08/m	7	787277	164,83/pc.	12	792920	1712,07/pc.	26	8140709	7,42/pc.	53
782213	250,41/m	32	787278	469,63/pc.	12	792921	1864,04/pc.	26	8141009	8,31/pc.	53
782214	sur demande	32	788164	20,36/pc.	15	792922	2022,11/pc.	26	8141209	9,07/pc.	53
782365	91,75/m	32	788165	29,21/pc.	15	792923	2022,11/pc.	26	8141509	9,89/pc.	53
782366	79,65/m	32	788572	5,55/pc.	40	792924	2123,52/pc.	26	8142009	10,99/pc.	53
782367	106,91/m	32	788573	6,57/pc.	41	794202	29,79/pc.	12	8142509	13,03/pc.	53
782368	130,81/m	32	788638	110,22/pc.	24	794202	29,79/pc.	128	8143009	14,62/pc.	53
782369	152,17/m	32	788639	170,57/pc.	34	794715	0,55/pc.	129	8143309	15,76/pc.	53
782370	175,17/m	32	788640	189,32/pc.	34	795051	14,02/pc.	18	8161003	8,24/m	44
782371	364,07/m	32	788641	250,75/pc.	34	795051	14,02/pc.	128	8161103	10,70/m	44
782382	12,14/pc.	33	788642	457,43/pc.	34	795132	0,82/pc.	129	8161503	13,89/m	44
782384	8,33/pc.	33	788643	481,07/pc.	34	795239	5,34/pc.	128	8162003	12,30/m	44
783155	20,90/m	6	788644	638,47/pc.	34	795240	4,00/pc.	9	8163003	17,07/m	44
783156	25,75/m	6	788645	1135,11/pc.	34	795241	5,55/pc.	9	8164003	19,77/m	44
783157	29,29/m	6	788646	2325,03/pc.	34	795242	6,33/pc.	9	8164303	22,68/m	44
783158	34,08/m	6	788647	238,07/pc.	34	795243	14,13/pc.	9	8165004	30,78/m	44
783159	37,57/m	6	788648	293,77/pc.	34	795316	7,95/pc.	8	8166004	33,19/m	44
783374	45,82/pc.	20	788649	359,50/pc.	34	795316	7,95/pc.	54	8167004	38,56/m	44
783375	732,65/m	32	788650	655,89/pc.	34	795317	8,98/pc.	8	8168004	53,12/m	44

Index

référence	prix en €	page	référence	prix en €	page	référence	prix en €	page	référence	prix en €	page
08180000	0,15/pc.	56	30152002	18,50/pc.	47	36073002	35,18/pc.	48	36242002	74,52/pc.	51
08190000	0,05/pc.	56	30152502	20,79/pc.	47	36073302	41,86/pc.	48	36242502	85,80/pc.	51
08190020	0,20/pc.	56	30153002	23,93/pc.	47	36074002	48,57/pc.	48	36243002	98,19/pc.	51
8250109	6,20/pc.	45	30153302	26,26/pc.	47	36075002	63,37/pc.	48	36243302	109,90/pc.	51
8250209	7,29/pc.	45	30154002	31,65/pc.	47	36076002	63,68/pc.	48	36244002	120,30/pc.	51
08461000	0,20/pc.	56	30155002	61,81/pc.	47	36110002	7,73/pc.	48	36245002	163,02/pc.	51
08461020	0,25/pc.	56	30156002	75,48/pc.	47	36150702	33,76/pc.	47	36246002	199,71/pc.	51
08462000	0,22/pc.	56	30160702	22,96/pc.	48	36151002	36,58/pc.	47	36252202	21,97/pc.	49
08462020	0,24/pc.	56	30161002	24,87/pc.	48	36151202	38,62/pc.	47	36252402	28,89/pc.	49
8601004	13,33/m	42	30161202	26,12/pc.	48	36151502	40,67/pc.	47	36252602	29,89/pc.	49
8601202	10,85/m	42	30161502	27,15/pc.	48	36152002	44,47/pc.	47	36254702	30,66/pc.	49
8601204	12,70/m	42	30162002	29,81/pc.	48	36152502	52,75/pc.	47	36254802	40,32/pc.	49
8601404	12,70/m	42	30162502	33,06/pc.	48	36153002	61,02/pc.	47	36256402	44,04/pc.	49
8602004	15,82/m	42	30163002	37,20/pc.	48	36153302	68,20/pc.	47	36430702	39,66/pc.	50
8602202	12,15/m	42	30163302	40,31/pc.	48	36154002	85,05/pc.	47	36431002	40,44/pc.	50
8602204	15,10/m	42	30164002	47,64/pc.	48	36155002	96,02/pc.	47	36431202	40,95/pc.	50
8602404	15,10/m	42	30165002	57,20/pc.	48	36156002	116,85/pc.	47	36431502	50,09/pc.	50
8603004	20,55/m	42	30166002	68,63/pc.	48	36160702	52,95/pc.	47	36432002	51,15/pc.	50
8603202	16,26/m	42	30220702	10,26/pc.	50	36161002	53,90/pc.	47	36432502	55,09/pc.	50
8603204	19,56/m	42	30221002	11,00/pc.	50	36161202	54,52/pc.	47	36433002	55,50/pc.	50
8603404	19,56/m	42	30221202	11,92/pc.	50	36161502	55,41/pc.	47	36433302	56,05/pc.	50
8604004	24,62/m	42	30221502	13,35/pc.	50	36162002	57,47/pc.	47	36434002	61,16/pc.	50
8604202	18,29/m	42	30222002	15,29/pc.	50	36162502	67,27/pc.	47	36435002	66,93/pc.	50
8604204	23,45/m	42	30222502	19,31/pc.	50	36163002	74,15/pc.	47	36436002	69,81/pc.	50
8604404	23,45/m	42	30223002	21,67/pc.	50	36163302	97,39/pc.	47	36510702	15,26/pc.	49
8605004	30,55/m	42	30223302	23,93/pc.	50	36164002	110,75/pc.	47	36511002	15,99/pc.	49
8605204	29,10/m	42	30224002	30,20/pc.	50	36165002	130,55/pc.	47	36511202	16,46/pc.	49
8605404	34,57/m	42	30225002	36,09/pc.	50	36166002	159,99/pc.	47	36511502	17,08/pc.	49
8606204	35,26/m	42	30226002	46,37/pc.	50	36180704	5,97/pc.	51	36512002	18,28/pc.	49
8750000	11,87/set	43	30230702	10,26/pc.	50	36181004	6,28/pc.	51	36512502	20,95/pc.	49
8856050	1,18/pc.	45	30231002	10,77/pc.	50	36181204	6,71/pc.	51	36513002	22,67/pc.	49
08890000	0,20/pc.	56	30231202	11,92/pc.	50	36181504	7,19/pc.	51	36513302	24,51/pc.	49
08890100	0,57/pc.	56	30231502	13,88/pc.	50	36182004	7,49/pc.	51	36514002	29,74/pc.	49
08891000	0,17/pc.	56	30232002	15,29/pc.	50	36182504	8,07/pc.	51	36520702	25,83/pc.	46
08900000	0,20/pc.	56	30232502	19,31/pc.	50	36183004	9,17/pc.	51	36521002	28,52/pc.	46
08901000	0,08/pc.	56	30233002	22,96/pc.	50	36183304	9,83/pc.	51	36521202	29,21/pc.	46
8940000	8,88/pc.	49	30233302	23,93/pc.	50	36184004	10,65/pc.	51	36521502	30,20/pc.	46
8960000	13,68/pc.	49	30234002	30,20/pc.	50	36185004	12,69/pc.	51	36522002	31,59/pc.	46
8980000	9,23/pc.	48	30235002	36,09/pc.	50	36186004	14,79/pc.	51	36522502	35,47/pc.	46
30060702	10,26/pc.	46	30236002	46,37/pc.	50	36220702	19,61/pc.	50	36523002	37,29/pc.	46
30061002	11,24/pc.	46	30252202	9,74/pc.	49	36221002	21,55/pc.	50	36523302	55,51/pc.	46
30061202	12,30/pc.	46	30252402	11,13/pc.	49	36221202	23,68/pc.	50	36524002	98,01/pc.	46
30061502	14,64/pc.	46	30252602	13,97/pc.	49	36221502	25,78/pc.	50	36525002	138,20/pc.	46
30062002	15,29/pc.	46	30254702	12,61/pc.	49	36222002	28,38/pc.	50	36526002	161,60/pc.	46
30062502	17,98/pc.	46	30254802	16,41/pc.	49	36222502	35,87/pc.	50	60211060	9,09/m	88
30063002	24,96/pc.	46	30256402	16,76/pc.	49	36223002	45,26/pc.	50	60211100	9,37/m	88
30063302	25,74/pc.	46	33105001	87,81/pc.	246	36223302	49,81/pc.	50	60211150	13,17/m	88
30064002	33,43/pc.	46	33105002	153,26/pc.	246	36224002	60,34/pc.	50	60211200	14,40/m	88
30065002	46,68/pc.	46	36060702	25,11/pc.	46	36225002	72,91/pc.	50	60211300	20,67/m	88
30066002	67,71/pc.	46	36061002	26,41/pc.	46	36226002	79,00/pc.	50	60211400	25,91/m	88
30070702	7,99/pc.	48	36061202	26,99/pc.	46	36230702	19,61/pc.	49	60212060	8,58/m	89
30071002	8,51/pc.	48	36061502	27,88/pc.	46	36231002	21,55/pc.	49	60212065	9,06/m	87
30071202	10,09/pc.	48	36062002	29,94/pc.	46	36231202	23,68/pc.	49	60212100	10,99/m	89
30071502	11,65/pc.	48	36062502	36,62/pc.	46	36231502	25,78/pc.	49	60212150	13,58/m	89
30072002	13,09/pc.	48	36063002	44,30/pc.	46	36232002	28,38/pc.	49	60212200	15,40/m	89
30072502	15,57/pc.	48	36063302	48,18/pc.	46	36232502	35,87/pc.	49	60212300	19,98/m	89
30073002	16,87/pc.	48	36064002	57,23/pc.	46	36233002	45,26/pc.	49	60212400	28,71/m	89
30073302	19,85/pc.	48	36065002	72,32/pc.	46	36233302	49,81/pc.	49	60212500	35,47/m	89
30074002	22,98/pc.	48	36066002	92,18/pc.	46	36234002	60,34/pc.	49	60212600	42,02/m	89
30075002	26,12/pc.	48	36070702	17,86/pc.	48	36235002	72,91/pc.	49	60213100	21,30/m	90
30076002	32,21/pc.	48	36071002	19,02/pc.	48	36236002	79,00/pc.	49	60213150	26,14/m	90
30150702	13,75/pc.	47	36071202	19,45/pc.	48	36240702	65,35/pc.	51	60213200	28,66/m	90
30151002	14,66/pc.	47	36071502	19,88/pc.	48	36241002	65,68/pc.	51	60213300	34,30/m	90
30151202	16,08/pc.	47	36072002	21,55/pc.	48	36241202	68,43/pc.	51	60213400	44,82/m	90
30151502	16,48/pc.	47	36072502	24,59/pc.	48	36241502	71,07/pc.	51	60213500	53,82/m	90

Index

référence	prix en €	page	référence	prix en €	page	référence	prix en €	page	référence	prix en €	page
60213600	55,00/m	90	60251400	113,02/m	88	60613315	24,27/m	106	62025153	9,17/pc.	79
60215020	16,31/m	106	60252060	37,36/m	89	60613320	28,84/m	106	62025153	9,17/pc.	109
60220000	13,42/m	107	60252065	49,20/m	87	60623206	16,30/m	106	62025153	9,17/pc.	132
60221060	9,42/m	88	60252100	50,88/m	89	60623306	19,09/m	106	62025153	9,17/pc.	135
60221100	9,71/m	88	60252150	60,27/m	89	60623310	23,82/m	106	62025203	10,55/pc.	79
60221150	13,64/m	88	60252200	69,40/m	89	60623315	25,93/m	106	62025203	10,55/pc.	109
60221200	14,91/m	88	60252300	87,72/m	89	60623320	30,74/m	106	62025203	10,55/pc.	132
60221300	21,41/m	88	60252400	109,67/m	89	60633206	23,36/m	106	62025203	10,55/pc.	135
60221400	26,85/m	88	60252500	129,75/m	89	60633306	28,48/m	106	62025303	12,08/pc.	79
60222060	9,46/m	89	60252600	147,44/m	89	60633310	33,60/m	106	62025303	12,08/pc.	109
60222065	10,06/m	87	60253100	63,89/m	90	60633315	35,85/m	106	62025303	12,08/pc.	132
60222100	12,38/m	89	60253150	71,99/m	90	60633320	44,08/m	106	62025303	12,08/pc.	135
60222100	12,38/m	130	60253200	91,11/m	90	60683206	20,56/m	106	62025403	17,44/pc.	79
60222150	15,30/m	89	60253300	109,82/m	90	60683306	25,07/m	106	62025403	17,44/pc.	109
60222150	15,30/m	130	60253400	128,93/m	90	60683310	29,57/m	106	62025403	17,44/pc.	132
60222200	17,36/m	89	60253500	149,66/m	90	60683315	31,51/m	106	62025403	17,44/pc.	135
60222200	17,36/m	130	60253600	167,65/m	90	60683320	38,80/m	106	62025503	20,24/pc.	79
60222300	22,50/m	89	60281060	9,94/m	88	62011060	3,13/pc.	102	62025503	20,24/pc.	109
60222300	22,50/m	130	60281100	11,00/m	88	62016020	7,31/pc.	101	62025603	23,03/pc.	79
60222400	32,33/m	89	60281150	14,21/m	88	62016021	1,82/pc.	101	62025603	23,03/pc.	109
60222400	32,33/m	130	60281200	16,16/m	88	62016022	6,02/pc.	102	62026010	3,27/pc.	100
60222500	39,94/m	89	60281300	22,35/m	88	62021060	3,13/pc.	102	62026011	6,09/pc.	100
60222600	47,33/m	89	60281400	26,59/m	88	62021104	6,29/pc.	80	62026020	7,31/pc.	101
60223100	22,07/m	90	60282060	11,27/m	89	62021104	6,29/pc.	108	62026021	1,82/pc.	101
60223150	27,07/m	90	60282065	13,24/m	87	62021104	6,29/pc.	131	62026022	6,02/pc.	102
60223200	29,69/m	90	60282100	15,26/m	89	62021104	6,29/pc.	134	62031060	4,20/pc.	102
60223300	35,53/m	90	60282150	18,85/m	89	62021154	8,13/pc.	80	62031084	0,99/pc.	110
60223400	46,44/m	90	60282200	22,32/m	89	62021154	8,13/pc.	108	62031085	0,49/pc.	111
60223500	55,75/m	90	60282300	30,50/m	89	62021154	8,13/pc.	131	62031090	6,22/pc.	131
60223600	56,98/m	90	60282400	40,29/m	89	62021154	8,13/pc.	134	62031090	6,22/pc.	134
60225020	16,90/m	106	60282500	47,51/m	89	62021204	9,31/pc.	80	62031104	9,63/pc.	80
60230000	16,62/m	107	60282600	56,07/m	89	62021204	9,31/pc.	108	62031104	9,63/pc.	108
60231060	11,29/m	88	60512060	8,96/m	92	62021204	9,31/pc.	131	62031104	9,63/pc.	131
60231100	12,49/m	88	60512100	11,34/m	92	62021204	9,31/pc.	134	62031104	9,63/pc.	134
60231150	16,16/m	88	60512150	13,89/m	92	62021304	10,98/pc.	80	62031154	12,32/pc.	80
60231200	18,35/m	88	60512200	15,64/m	92	62021304	10,98/pc.	108	62031154	12,32/pc.	108
60231300	25,41/m	88	60512300	20,27/m	92	62021304	10,98/pc.	131	62031154	12,32/pc.	131
60231400	30,21/m	88	60512400	29,02/m	92	62021304	10,98/pc.	134	62031154	12,32/pc.	134
60232060	12,79/m	89	60512500	35,74/m	92	62021404	16,42/pc.	80	62031204	13,20/pc.	80
60232065	15,02/m	87	60512600	42,25/m	92	62021404	16,42/pc.	108	62031204	13,20/pc.	108
60232100	17,30/m	89	60512600	42,25/m	92	62021404	16,42/pc.	131	62031204	13,20/pc.	131
60232100	17,30/m	130	60513100	21,60/m	92	62021404	16,42/pc.	134	62031204	13,20/pc.	134
60232150	21,41/m	89	60513150	26,44/m	92	62021504	18,77/pc.	80	62031304	14,12/pc.	80
60232150	21,41/m	130	60513200	28,68/m	92	62021504	18,77/pc.	111	62031304	14,12/pc.	108
60232200	25,35/m	89	60513300	34,47/m	92	62021504	18,77/pc.	111	62031304	14,12/pc.	131
60232200	25,35/m	130	60513400	44,87/m	92	62021604	22,39/pc.	80	62031304	14,12/pc.	134
60232300	34,67/m	89	60513500	53,33/m	92	62021604	22,39/pc.	111	62031404	21,79/pc.	80
60232300	34,67/m	130	60513600	54,27/m	92	62022104	12,42/pc.	80	62031404	21,79/pc.	108
60232400	45,79/m	89	60522060	9,77/m	92	62022104	12,42/pc.	108	62031404	21,79/pc.	131
60232400	45,79/m	130	60522100	12,57/m	92	62022104	12,42/pc.	131	62031404	21,79/pc.	134
60232500	54,00/m	89	60522150	15,40/m	92	62022154	13,05/pc.	80	62031504	25,27/pc.	80
60232600	63,73/m	89	60522200	17,36/m	92	62022154	13,05/pc.	108	62031504	25,27/pc.	111
60233100	27,28/m	90	60522300	22,41/m	92	62022154	13,05/pc.	131	62031604	30,25/pc.	80
60233150	30,32/m	90	60522400	31,98/m	92	62022204	14,03/pc.	80	62031604	30,25/pc.	111
60233200	39,63/m	90	60522500	39,64/m	92	62022204	14,03/pc.	108	62032104	16,42/pc.	80
60233300	50,43/m	90	60522600	46,65/m	92	62022204	14,03/pc.	131	62032104	16,42/pc.	108
60233400	61,53/m	90	60523100	22,10/m	92	62022304	16,42/pc.	80	62032104	16,42/pc.	131
60233500	71,79/m	90	60523150	27,03/m	92	62022304	16,42/pc.	108	62032154	18,06/pc.	80
60233600	76,65/m	90	60523200	29,43/m	92	62022304	16,42/pc.	131	62032154	18,06/pc.	108
60250000	30,97/m	107	60523300	35,22/m	92	62022404	24,23/pc.	80	62032154	18,06/pc.	131
60251060	31,06/m	88	60523400	45,86/m	92	62022404	24,23/pc.	108	62032204	20,16/pc.	80
60251100	37,01/m	88	60523500	55,32/m	92	62022404	24,23/pc.	131	62032204	20,16/pc.	108
60251150	44,05/m	88	60523600	56,34/m	92	62025103	7,86/pc.	79	62032204	20,16/pc.	131
60251200	57,02/m	88	60613206	15,28/m	106	62025103	7,86/pc.	109	62032304	24,16/pc.	80
60251300	75,39/m	88	60613306	17,90/m	106	62025103	7,86/pc.	132	62032304	24,16/pc.	108
			60613310	22,32/m	106	62025103	7,86/pc.	135			

Index

référence	prix en €	page	référence	prix en €	page	référence	prix en €	page	référence	prix en €	page
62032304	24,16/pc.	131	62055203	33,69/pc.	79	62305430	9,43/pc.	117	63052154	16,34/pc.	81
62032404	36,94/pc.	80	62055203	33,69/pc.	109	62305440	9,73/pc.	117	63052154	16,34/pc.	110
62032404	36,94/pc.	108	62055303	40,90/pc.	79	62306230	8,53/pc.	118	63052204	18,95/pc.	81
62032404	36,94/pc.	131	62055303	40,90/pc.	109	62306240	8,83/pc.	118	63052204	18,95/pc.	110
62035001	6,22/pc.	132	62055403	68,52/pc.	79	62306250	9,05/pc.	118	63052304	23,67/pc.	81
62035001	6,22/pc.	135	62055403	68,52/pc.	109	62307231	20,51/pc.	117	63052304	23,67/pc.	110
62035103	12,14/pc.	79	62055503	77,33/pc.	79	62307233	22,23/pc.	117	63052404	30,11/pc.	81
62035103	12,14/pc.	109	62055503	77,33/pc.	109	62307241	20,58/pc.	117	63052404	30,11/pc.	110
62035103	12,14/pc.	132	62055603	87,86/pc.	79	62307243	22,30/pc.	117	63052504	36,77/pc.	81
62035103	12,14/pc.	135	62055603	87,86/pc.	109	62307631	27,32/pc.	117	63052504	36,77/pc.	110
62035153	13,57/pc.	79	62057002	sur demande	79	62307633	31,96/pc.	117	63052604	44,60/pc.	81
62035153	13,57/pc.	109	62057002	sur demande	109	62307641	27,32/pc.	117	63052604	44,60/pc.	110
62035153	13,57/pc.	132	62061060	7,52/pc.	102	62307643	30,76/pc.	117	63082104	9,02/pc.	110
62035153	13,57/pc.	135	62066010	12,42/pc.	100	62308231	18,56/pc.	118	63082154	9,15/pc.	110
62035203	16,03/pc.	79	62066011	26,03/pc.	100	62308233	20,06/pc.	118	63082204	9,26/pc.	110
62035203	16,03/pc.	109	62066022	15,81/pc.	102	62308241	18,48/pc.	118	63082304	11,11/pc.	110
62035203	16,03/pc.	132	62081060	4,20/pc.	102	62308243	20,21/pc.	118	63082404	13,49/pc.	110
62035203	16,03/pc.	135	62081104	9,63/pc.	108	62308631	26,49/pc.	118	63082504	15,93/pc.	110
62035303	19,85/pc.	79	62081154	12,32/pc.	108	62308633	29,04/pc.	118	63082604	19,06/pc.	110
62035303	19,85/pc.	109	62081204	13,20/pc.	108	62308641	26,72/pc.	118	64010020	4,13/pc.	94
62035303	19,85/pc.	132	62081304	14,12/pc.	108	62308643	29,27/pc.	118	64010035	2,32/pc.	94
62035303	19,85/pc.	135	62081404	21,79/pc.	108	62309501	98,79/pc.	118	64010036	3,31/pc.	94
62035403	22,20/pc.	79	62081504	25,27/pc.	111	62309502	114,43/pc.	118	64010038	2,62/pc.	93
62035403	22,20/pc.	109	62081604	30,25/pc.	111	62309503	130,15/pc.	118	64010040	2,62/pc.	93
62035403	22,20/pc.	132	62082104	16,42/pc.	108	62310201	20,06/pc.	118	64010041	1,47/pc.	95
62035403	22,20/pc.	135	62082154	18,06/pc.	108	63022104	4,26/pc.	81	64010046	3,93/pc.	93
62035503	27,68/pc.	79	62082204	20,16/pc.	108	63022104	4,26/pc.	110	64010048	3,93/pc.	93
62035503	27,68/pc.	109	62082304	24,16/pc.	108	63022104	4,26/pc.	134	64010058	0,72/pc.	87
62035603	32,21/pc.	79	62082404	36,94/pc.	108	63022154	4,70/pc.	81	64010059	0,20/pc.	60
62035603	32,21/pc.	109	62085103	12,14/pc.	109	63022154	4,70/pc.	110	64010059	0,20/pc.	112
62036010	7,02/pc.	100	62085153	13,57/pc.	109	63022154	4,70/pc.	134	64010060	1,14/pc.	96
62036011	10,70/pc.	100	62085203	16,03/pc.	109	63022204	5,90/pc.	81	64010061	1,55/pc.	93
62036020	10,88/pc.	101	62085303	19,85/pc.	109	63022204	5,90/pc.	110	64010062	0,62/pc.	96
62036021	3,04/pc.	101	62085403	22,20/pc.	109	63022204	5,90/pc.	134	64010072	1,41/pc.	96
62036022	8,02/pc.	102	62085503	27,68/pc.	109	63022304	6,94/pc.	81	64020030	4,13/pc.	94
62037002	19,53/pc.	79	62085603	32,21/pc.	109	63022304	6,94/pc.	110	64020035	2,32/pc.	94
62037002	19,53/pc.	109	62086010	7,02/pc.	100	63022304	6,94/pc.	134	64020036	3,31/pc.	94
62051104	19,90/pc.	80	62086011	10,70/pc.	100	63022404	9,38/pc.	81	64020038	2,90/pc.	93
62051104	19,90/pc.	108	62086020	10,88/pc.	101	63022404	9,38/pc.	110	64020040	2,90/pc.	93
62051154	24,69/pc.	80	62086021	3,04/pc.	101	63022404	9,38/pc.	134	64020041	1,47/pc.	95
62051154	24,69/pc.	108	62086022	8,02/pc.	102	63022504	10,57/pc.	81	64020046	4,28/pc.	93
62051204	31,06/pc.	80	62301100	6,14/pc.	117	63022504	10,57/pc.	110	64020048	4,28/pc.	93
62051204	31,06/pc.	108	62301400	6,96/pc.	117	63022604	13,97/pc.	81	64020058	0,78/pc.	87
62051304	37,64/pc.	80	62301800	12,65/pc.	117	63022604	13,97/pc.	110	64020059	0,20/pc.	112
62051304	37,64/pc.	108	62302102	0,67/m	117	63032104	7,08/pc.	81	64020060	1,14/pc.	96
62051404	45,79/pc.	80	62302401	0,75/m	117	63032104	7,08/pc.	110	64020060	1,14/pc.	130
62051404	45,79/pc.	108	62302801	1,12/m	117	63032104	7,08/pc.	134	64020061	1,55/pc.	93
62051504	52,91/pc.	80	62303101	9,80/pc.	117	63032154	7,57/pc.	81	64020061	1,55/pc.	130
62051504	52,91/pc.	111	62303103	12,50/pc.	117	63032154	7,57/pc.	110	64020062	0,62/pc.	96
62051604	60,21/pc.	80	62303105	15,19/pc.	117	63032154	7,57/pc.	134	64020072	1,41/pc.	96
62051604	60,21/pc.	111	62303301	11,90/pc.	117	63032204	9,26/pc.	81	64030030	4,93/pc.	94
62052104	33,97/pc.	80	62303303	15,05/pc.	117	63032204	9,26/pc.	110	64030035	3,25/pc.	94
62052104	33,97/pc.	108	62303305	18,11/pc.	117	63032204	9,26/pc.	134	64030036	4,63/pc.	94
62052154	36,84/pc.	80	62303601	27,92/pc.	117	63032304	11,11/pc.	81	64030041	2,33/pc.	95
62052154	36,84/pc.	108	62303603	31,43/pc.	117	63032304	11,11/pc.	110	64030058	0,98/pc.	87
62052204	48,44/pc.	80	62303605	34,95/pc.	117	63032304	11,11/pc.	134	64030059	0,25/pc.	68
62052204	48,44/pc.	108	62304101	10,03/pc.	117	63032404	13,49/pc.	81	64030059	0,25/pc.	112
62052304	55,65/pc.	80	62304103	12,72/pc.	117	63032404	13,49/pc.	110	64030059	0,25/pc.	134
62052304	55,65/pc.	108	62304105	21,18/pc.	117	63032404	13,49/pc.	134	64030060	1,72/pc.	96
62052404	64,31/pc.	80	62304301	12,20/pc.	117	63032504	15,93/pc.	81	64030060	1,72/pc.	130
62052404	64,31/pc.	108	62304303	15,35/pc.	117	63032504	15,93/pc.	110	64030061	2,19/pc.	93
62055103	27,32/pc.	79	62304305	18,48/pc.	117	63032604	19,06/pc.	81	64030061	2,19/pc.	130
62055103	27,32/pc.	109	62304601	13,77/pc.	117	63032604	19,06/pc.	110	64030062	0,65/pc.	96
62055153	30,12/pc.	79	62304603	17,36/pc.	117	63052104	13,53/pc.	81	64030072	1,94/pc.	96
62055153	30,12/pc.	109	62304605	30,08/pc.	117	63052104	13,53/pc.	110	64030160	2,10/pc.	131

Index

référence	prix en €	page	référence	prix en €	page	référence	prix en €	page	référence	prix en €	page
68000010	2,03/pc.	99	70023230	36,74/pc.	64	70027150	16,79/pc.	64	70033360	70,91/pc.	72
68000020	1,17/pc.	62	70023240	52,88/pc.	64	70028110	36,24/pc.	63	70033420	54,80/pc.	72
68000020	1,17/pc.	70	70023250	60,54/pc.	64	70028115	38,21/pc.	63	70033430	61,31/pc.	72
68000020	1,17/pc.	98	70023260	63,96/pc.	64	70028120	44,51/pc.	63	70033440	67,57/pc.	72
68000032	9,46/pc.	95	70023320	39,84/pc.	64	70028130	49,94/pc.	63	70033450	74,31/pc.	72
68000034	5,95/pc.	62	70023330	45,86/pc.	64	70028210	36,80/pc.	63	70033460	76,95/pc.	72
68000034	5,95/pc.	70	70023340	53,95/pc.	64	70028215	39,05/pc.	63	70034110	45,63/pc.	73
68000034	5,95/pc.	95	70023350	58,57/pc.	64	70028220	45,26/pc.	63	70034115	50,37/pc.	73
68000040	1,42/pc.	99	70023360	59,80/pc.	64	70028230	51,03/pc.	63	70034120	58,32/pc.	73
68000049	0,45/pc.	98	70023420	45,63/pc.	64	70030110	29,32/pc.	71	70034130	67,63/pc.	73
68000052	56,99/pc.	98	70023430	49,52/pc.	64	70030115	32,66/pc.	71	70034210	47,49/pc.	73
68000053	98,00/pc.	98	70023440	60,10/pc.	64	70030120	37,52/pc.	71	70034215	52,61/pc.	73
68000058	313,25/pc.	98	70023450	66,49/pc.	64	70030130	49,69/pc.	71	70034220	60,76/pc.	73
68000060	2,97/pc.	104	70023460	69,14/pc.	64	70030210	31,51/pc.	71	70034230	82,00/pc.	73
68000066	330,54/pc.	104	70024110	36,98/pc.	65	70030215	34,17/pc.	71	70034240	130,78/pc.	73
70020110	25,54/pc.	63	70024115	39,90/pc.	65	70030220	39,11/pc.	71	70034250	187,87/pc.	73
70020115	28,52/pc.	63	70024120	46,22/pc.	65	70030230	53,17/pc.	71	70034260	215,37/pc.	73
70020120	32,66/pc.	63	70024130	54,80/pc.	65	70030240	91,12/pc.	71	70034320	68,48/pc.	73
70020130	37,90/pc.	63	70024210	37,95/pc.	65	70030250	139,35/pc.	71	70034330	91,48/pc.	73
70020206	24,38/pc.	63	70024215	38,44/pc.	65	70030260	168,18/pc.	71	70034340	138,26/pc.	73
70020210	24,38/pc.	63	70024220	44,51/pc.	65	70030320	43,06/pc.	71	70034350	227,96/pc.	73
70020215	26,16/pc.	63	70024230	54,31/pc.	65	70030330	56,86/pc.	71	70034360	278,67/pc.	73
70020220	28,08/pc.	63	70024240	61,80/pc.	65	70030340	108,98/pc.	71	70035110	38,74/pc.	73
70020230	41,55/pc.	63	70024250	115,45/pc.	65	70030350	153,38/pc.	71	70035115	43,24/pc.	73
70020240	53,68/pc.	63	70024260	159,10/pc.	65	70030360	176,45/pc.	71	70035120	49,57/pc.	73
70020250	61,88/pc.	63	70024320	51,58/pc.	65	70030420	76,75/pc.	71	70035130	57,47/pc.	73
70020260	81,09/pc.	63	70024330	62,83/pc.	65	70030430	92,27/pc.	71	70035210	40,76/pc.	73
70020320	38,37/pc.	63	70024340	71,66/pc.	65	70030440	166,77/pc.	71	70035215	45,68/pc.	73
70020330	49,52/pc.	63	70024350	130,03/pc.	65	70030450	200,67/pc.	71	70035220	52,18/pc.	73
70020340	107,54/pc.	63	70024360	179,18/pc.	65	70030460	260,02/pc.	71	70035230	72,07/pc.	73
70020350	130,58/pc.	63	70025110	31,38/pc.	65	70031100	19,72/pc.	74	70035240	94,72/pc.	73
70020360	134,78/pc.	63	70025115	35,03/pc.	65	70031200	21,09/pc.	74	70035250	110,70/pc.	73
70020420	54,80/pc.	63	70025120	40,15/pc.	65	70031300	24,99/pc.	74	70035260	120,73/pc.	73
70020430	83,14/pc.	63	70025130	46,53/pc.	65	70031400	25,54/pc.	74	70035320	60,40/pc.	73
70020440	116,24/pc.	63	70025206	23,68/pc.	65	70032110	40,81/pc.	72	70035330	74,57/pc.	73
70020450	146,23/pc.	63	70025210	23,68/pc.	65	70032115	45,55/pc.	72	70035340	89,60/pc.	73
70020460	170,55/pc.	63	70025215	28,33/pc.	65	70032120	53,41/pc.	72	70035350	119,33/pc.	73
70021100	13,81/pc.	66	70025220	31,17/pc.	65	70032130	59,85/pc.	72	70035360	124,26/pc.	73
70021200	14,42/pc.	66	70025230	46,92/pc.	65	70032210	43,49/pc.	72	70036110	39,35/pc.	74
70021300	17,40/pc.	66	70025240	62,12/pc.	65	70032215	47,63/pc.	72	70036115	43,99/pc.	74
70021400	17,51/pc.	66	70025250	68,41/pc.	65	70032220	54,43/pc.	72	70036120	50,37/pc.	74
70022110	33,81/pc.	64	70025260	89,69/pc.	65	70032230	70,24/pc.	72	70036130	58,40/pc.	74
70022115	37,77/pc.	64	70025320	47,87/pc.	65	70032240	119,76/pc.	72	70036210	41,00/pc.	74
70022120	43,30/pc.	64	70025330	56,56/pc.	65	70032250	166,23/pc.	72	70036215	45,92/pc.	74
70022130	50,17/pc.	64	70025340	68,12/pc.	65	70032260	199,86/pc.	72	70036220	52,49/pc.	74
70022210	35,22/pc.	64	70025350	99,56/pc.	65	70032320	61,98/pc.	72	70036230	64,49/pc.	74
70022215	39,47/pc.	64	70025360	104,25/pc.	65	70032330	84,90/pc.	72	70036240	83,98/pc.	74
70022220	45,12/pc.	64	70026110	31,38/pc.	66	70032340	166,35/pc.	72	70036250	94,73/pc.	74
70022230	52,12/pc.	64	70026115	35,03/pc.	66	70032350	208,33/pc.	72	70036260	98,40/pc.	74
70022240	97,07/pc.	64	70026120	40,15/pc.	66	70032360	254,36/pc.	72	70036320	54,80/pc.	74
70022250	139,35/pc.	64	70026130	46,53/pc.	66	70033110	31,38/pc.	72	70036330	68,97/pc.	74
70022260	159,25/pc.	64	70026206	23,68/pc.	66	70033115	35,03/pc.	72	70036340	83,39/pc.	74
70022320	50,79/pc.	64	70026210	23,68/pc.	66	70033120	41,11/pc.	72	70036350	96,05/pc.	74
70022330	65,33/pc.	64	70026215	28,33/pc.	66	70033130	47,63/pc.	72	70036360	99,70/pc.	74
70022340	116,16/pc.	64	70026220	31,17/pc.	66	70033210	33,45/pc.	72	70037100	37,40/pc.	71
70022350	135,88/pc.	64	70026230	46,92/pc.	66	70033215	37,47/pc.	72	70037150	42,15/pc.	71
70022360	172,80/pc.	64	70026240	62,12/pc.	66	70033220	42,82/pc.	72	70038110	40,76/pc.	71
70023110	25,35/pc.	64	70026250	68,41/pc.	66	70033230	49,45/pc.	72	70038115	43,60/pc.	71
70023115	28,23/pc.	64	70026260	89,69/pc.	66	70033240	58,21/pc.	72	70038120	51,88/pc.	71
70023120	32,91/pc.	64	70026320	42,03/pc.	66	70033250	63,62/pc.	72	70038130	60,52/pc.	71
70023130	37,52/pc.	64	70026330	57,78/pc.	66	70033260	69,47/pc.	72	70038210	41,96/pc.	71
70023206	20,91/pc.	64	70026340	64,84/pc.	66	70033320	50,42/pc.	72	70038215	45,43/pc.	71
70023210	20,91/pc.	64	70026350	77,61/pc.	66	70033330	56,86/pc.	72	70038220	53,83/pc.	71
70023215	21,85/pc.	64	70026360	82,16/pc.	66	70033340	60,81/pc.	72	70038230	63,44/pc.	71
70023220	23,68/pc.	64	70027100	14,79/pc.	64	70033350	68,07/pc.	72	70039110	23,90/pc.	71

Index

référence	prix en €	page	référence	prix en €	page	référence	prix en €	page	référence	prix en €	page
44201004/2	77,79/pc.	231	91110014/2	32,60/pc.	247	IDT0004	237,10/pc.	228	K8404HFHB	18,61/pc.	197
44201004/4	77,79/pc.	231	91110014/6	34,91/pc.	247	IDT0009	461,46/pc.	227	K8405HB	15,09/pc.	197
44202004/2	97,32/pc.	231	91110016F2	26,45/pc.	247	IDT0010	461,46/pc.	227	K8405HFHB	18,61/pc.	197
44202004/4	97,32/pc.	231	91110016F6	32,39/pc.	247	IDT0011	138,12/pc.	227	K8406HB	15,09/pc.	197
46100001/1	24,95/pc.	241	91110018F2	31,69/pc.	247	IDT0012	138,12/pc.	227	K8406HFHB	18,61/pc.	197
46100001/3	24,95/pc.	241	91110018F6	39,57/pc.	247	IDT0019	434,31/pc.	225	K8407HB	5,95/pc.	197
46100002/1	25,75/pc.	241	91110020/2	22,29/pc.	247	IDT0020	457,68/pc.	225	K8407HFHB	10,58/pc.	197
46100002/3	25,75/pc.	241	91110020/6	27,57/pc.	247	IDT0021	491,87/pc.	225	K8440-11HB	3,59/pc.	205
46101001F1	50,27/pc.	241	91111001/2	4,75/pc.	246	IDT0022	434,31/pc.	225	K8440-12HB	4,70/pc.	205
46101001F3	50,27/pc.	241	91111002/2	2,59/pc.	246	IDT0023	457,68/pc.	225	K8440-13HB	7,67/pc.	205
46102001F1	56,75/pc.	241	91111002/6	2,76/pc.	246	IDT0024	491,87/pc.	225	K8441HB	16,01/pc.	203
46102001F3	56,75/pc.	241	91111003/2	2,59/pc.	246	IDT2917	10,29/pc.	224	K8442HB	16,01/pc.	203
46203002F1	85,95/pc.	241	91111003/6	2,76/pc.	246	IDT2941	138,12/pc.	226	K8443HB	20,99/pc.	203
46203002F3	85,95/pc.	241	91111005/2	4,25/pc.	246	IDT2942	138,12/pc.	226	K8444HB	20,99/pc.	203
46203023F1	110,82/pc.	241	91113003/1	11,44/pc.	244	IDT6298	177,83/pc.	228	K8445HB	20,99/pc.	203
46203023F3	110,82/pc.	241	91113003/3	11,44/pc.	244	IDT6299	177,83/pc.	228	K8446HB	20,99/pc.	203
60102011RSC	305,20/bt.	104	91113004/1	34,43/pc.	244	IDT6300	362,59/pc.	226	K8447HB	9,14/pc.	203
66101001F1	58,06/pc.	236	91113004/3	34,43/pc.	244	IDT6301	362,59/pc.	226	K8450-11HB	3,79/pc.	205
66101001F3	58,06/pc.	236	91113005/1	13,74/pc.	244	IDT6302	310,12/pc.	224	K8450-11HFHB	6,44/pc.	205
66101002F1	68,53/pc.	236	91113005/3	13,74/pc.	244	IDT6303	323,76/pc.	224	K8450-12HB	4,70/pc.	205
66101002F3	68,53/pc.	236	91113006/1	11,24/pc.	244	IDT6304	343,61/pc.	224	K8450-12HFHB	7,84/pc.	205
66101003F1	83,59/pc.	236	91113006/3	11,24/pc.	244	IDT6305	310,12/pc.	224	K8450-13HB	7,67/pc.	205
66101003F3	83,59/pc.	236	91113007/1	3,52/pc.	244	IDT6306	323,76/pc.	224	K8450-13HFHB	12,54/pc.	205
66103001F1	70,42/pc.	238	91113007/3	3,52/pc.	244	IDT6307	343,61/pc.	224	K8451HB	10,60/pc.	201
66103001F3	70,42/pc.	238	91113009/1	17,27/pc.	244	IDT6893	13,67/pc.	225	K8451HFHB	12,59/pc.	201
66103002F1	87,15/pc.	238	91113009/3	17,27/pc.	244	IDT6894	12,53/pc.	224	K8452HB	9,88/pc.	201
66103002F3	87,15/pc.	238	91113010/1	48,10/pc.	245	IDT6894	12,53/pc.	225	K8452HFHB	12,01/pc.	201
66103003F1	77,19/pc.	237	91113010/3	48,10/pc.	245	IDT6894	12,53/pc.	226	K8453HB	16,23/pc.	201
66103003F3	77,19/pc.	237	91113011/1	5,61/pc.	245	IDT6894	12,53/pc.	227	K8453HFHB	18,32/pc.	201
66103004F1	85,78/pc.	237	91113011/3	5,61/pc.	245	IDT6894	12,53/pc.	228	K8454HB	16,23/pc.	201
66103004F3	85,78/pc.	237	91113012/1	4,54/pc.	245	IDT7218	473,83/pc.	224	K8454HFHB	18,32/pc.	201
66103005F1	93,37/pc.	237	91113012/3	4,54/pc.	245	IDT7219	749,12/pc.	225	K8455HB	17,17/pc.	201
66103005F3	93,37/pc.	237	91113013/1	1,58/pc.	245	IDT7239	473,83/pc.	224	K8455HFHB	19,36/pc.	201
66108001F1	135,34/pc.	238	91113013/3	1,58/pc.	245	IDT7240	749,12/pc.	225	K8456HB	16,23/pc.	201
66108001F3	135,34/pc.	238	91113014/1	1,28/pc.	245	K5216EZNZNF	189,14/bt.	137	K8456HFHB	18,32/pc.	201
74109001F3	195,38/pc.	243	91113014/3	1,28/pc.	245	K5216EZNMS	407,49/bt.	137	K8457HB	5,89/pc.	201
74109002F3	205,13/pc.	243	91113019/1	5,18/pc.	245	K5220ZNF	201,00/bt.	137	K8457HFHB	7,31/pc.	201
74109003F3	236,25/pc.	243	91113019/3	5,18/pc.	245	K5220ZNMS	349,34/bt.	137	K8461HB	12,00/pc.	202
74109004F3	245,87/pc.	243	91113029/1	25,32/pc.	244	K5225ZNF	214,20/bt.	137	K8462HB	12,00/pc.	202
74109005F3	292,98/pc.	243	91113029/3	25,32/pc.	244	K5225ZNMS	373,26/bt.	137	K8463HB	19,29/pc.	202
74109006F3	299,57/pc.	243	92114001/1	40,06/set	242	K5232ZNF	125,10/bt.	137	K8464HB	19,29/pc.	202
8602204UP9005N	26,41/m	42	92114001/3	40,06/set	242	K5232ZNMS	238,05/bt.	137	K8465HB	19,29/pc.	202
8602204UP9010N	26,41/m	42	92114002/1	18,07/pc.	242	K5240ZNF	122,40/bt.	137	K8466HB	19,29/pc.	202
8602404UP9005N	26,41/m	42	92114002/3	18,07/pc.	242	K5250ZNF	145,44/bt.	137	K8467HB	6,83/pc.	202
8602404UP9010N	26,41/m	42	92114005/1	10,89/set	242	K5250ZNMS	121,69/bt.	137	K8471HB	11,76/pc.	198
8603204UP9005N	34,26/m	42	92114005/3	10,89/set	242	K5263ZNF	172,08/bt.	137	K8472HB	11,76/pc.	198
8603204UP9010N	34,26/m	42	92114006/1	10,89/set	242	K5263ZNMS	187,74/bt.	137	K8473HB	20,70/pc.	198
8603404UP9005N	34,26/m	42	92114006/3	10,89/set	242	K6706PO	252,20/bt.	136	K8474HB	20,70/pc.	198
8603404UP9010N	34,26/m	42	BODO NA-L	296,35/pc.	178	K6708PO	285,08/bt.	136	K8475HB	20,70/pc.	198
8605204UP9005N	50,93/m	42	BODO NAT-L	375,93/pc.	178	K6708POGMT	396,00/bt.	136	K8476HB	20,70/pc.	198
8605204UP9010N	50,93/m	42	BODO NL	318,53/pc.	157	K6710PO	288,96/bt.	136	K8477HB	8,23/pc.	198
8605404UP9005N	60,51/m	42	BODO NL-CR	583,55/pc.	157	K6710POGMT	468,80/bt.	136	K8481HB	13,17/pc.	199
8605404UP9010N	60,51/m	42	BODO NL-E	1304,13/pc.	157	K6712PO	291,06/bt.	136	K8482HB	13,17/pc.	199
91110006F2	19,78/pc.	247	BODO NL-MMS	1057,14/pc.	157	K6712POGMT	540,40/bt.	136	K8483HB	21,17/pc.	199
91110006F6	25,04/pc.	247	BODO NL-SW	429,90/pc.	157	K6716EDPO	316,80/bt.	136	K8484HB	21,17/pc.	199
91110007F2	24,97/pc.	247	BODO TL-G	55,26/pc.	157	K6716EDPOGMT	345,60/bt.	136	K8485HB	21,17/pc.	199
91110007F6	31,27/pc.	247	BODO TL-S	55,26/pc.	157	K6716EPO	216,19/bt.	136	K8486HB	21,17/pc.	199
91110008/2	19,16/pc.	247	CEZ070	7,74/pc.	53	K6716EPOGMT	324,82/bt.	136	K8487HB	9,41/pc.	199
91110008/6	24,51/pc.	247	CEZ100	8,30/pc.	53	K8401HB	7,56/pc.	197	K8491HB	17,43/pc.	200
91110009/2	21,77/pc.	247	CEZ120	8,66/pc.	53	K8401HFHB	10,58/pc.	197	K8492HB	17,65/pc.	200
91110009/6	26,90/pc.	247	CEZ150	11,91/pc.	53	K8402HB	7,56/pc.	197	K8493HB	27,77/pc.	200
91110010/2	26,45/pc.	247	CEZ200	13,25/pc.	53	K8402HFHB	10,58/pc.	197	K8494HB	27,77/pc.	200
91110010/6	32,92/pc.	247	CEZ300	20,45/pc.	53	K8403HB	15,09/pc.	197	K8495HB	27,77/pc.	200
91110012/2	26,22/pc.	247	CEZ400	26,74/pc.	53	K8403HFHB	18,61/pc.	197	K8496HB	27,77/pc.	200
91110012/6	32,67/pc.	247	IDT0003	237,10/pc.	228	K8404HB	15,09/pc.	197	K8497HB	12,48/pc.	200

Index

référence	prix en €	page	référence	prix en €	page	référence	prix en €	page	référence	prix en €	page
K8501HB	4,47/pc.	220	K8622HB	1,07/pc.	217	K8716HB	2,01/pc.	216	K8914HB	1,62/pc.	218
K8501HFHB	12,48/pc.	221	K8622HFHB	3,53/pc.	218	K8731HB	0,99/pc.	216	K8915HB	1,62/pc.	218
K8502HB	4,47/pc.	220	K8623HB	1,69/pc.	217	K8732HB	0,99/pc.	216	K8916HB	1,62/pc.	218
K8502HFHB	12,48/pc.	221	K8623HFHB	5,15/pc.	218	K8733HB	1,50/pc.	216	K8921HB	1,01/pc.	217
K8503HB	6,35/pc.	220	K8624HB	1,69/pc.	217	K8734HB	1,50/pc.	216	K8921HFHB	3,25/pc.	217
K8503HFHB	16,48/pc.	221	K8624HFHB	5,15/pc.	218	K8735HB	1,50/pc.	216	K8922HB	1,01/pc.	217
K8504/EKDHB	5,76/pc.	220	K8625HB	1,69/pc.	217	K8736HB	1,50/pc.	216	K8922HFHB	3,25/pc.	217
K8504HB	6,11/pc.	220	K8625HFHB	5,15/pc.	218	K8791HB	1,13/pc.	216	K8923HB	1,50/pc.	217
K8504HFHB	16,48/pc.	221	K8626HB	1,69/pc.	217	K8792HB	1,13/pc.	216	K8923HFHB	4,80/pc.	217
K8505HB	6,35/pc.	220	K8626HFHB	5,15/pc.	218	K8793HB	1,62/pc.	216	K8924HB	1,50/pc.	217
K8505HFHB	16,48/pc.	221	K8631HB	2,04/pc.	219	K8794HB	1,62/pc.	216	K8924HFHB	4,80/pc.	217
K8506HB	6,35/pc.	220	K8631HFHB	6,16/pc.	219	K8795HB	1,62/pc.	216	K8925HB	1,50/pc.	217
K8506HFHB	16,48/pc.	221	K8632HB	2,04/pc.	219	K8796HB	1,62/pc.	216	K8925HFHB	4,80/pc.	217
K8511HB	5,89/pc.	221	K8632HFHB	6,16/pc.	219	K8821LHB	2,88/pc.	212	K8926HB	1,50/pc.	217
K8512HB	5,89/pc.	221	K8633HB	2,76/pc.	219	K8821PHB	2,88/pc.	212	K8926HFHB	4,80/pc.	217
K8513HB	7,77/pc.	221	K8633HFHB	8,66/pc.	219	K8822HB	2,88/pc.	212	K8931HB	1,65/pc.	218
K8514/EKDHB	7,77/pc.	221	K8634HB	2,76/pc.	219	K8823/13LHB	3,91/pc.	213	K8932HB	1,65/pc.	218
K8514HB	7,77/pc.	221	K8634HFHB	8,66/pc.	219	K8823/13PHB	3,91/pc.	213	K8933HB	2,33/pc.	218
K8515HB	7,77/pc.	221	K8635HB	2,76/pc.	219	K8824/12HB	3,91/pc.	213	K8934HB	2,33/pc.	218
K8516HB	7,77/pc.	221	K8635HFHB	8,66/pc.	219	K8824/40HB	3,91/pc.	213	K8935HB	2,33/pc.	218
K8541HB	12,96/pc.	206	K8636HB	2,76/pc.	219	K8824/41HB	3,91/pc.	213	K8936HB	2,33/pc.	218
K8542HB	12,96/pc.	206	K8636HFHB	8,66/pc.	219	K8824/43HB	3,91/pc.	213	K8991HB	2,12/pc.	220
K8543HB	19,53/pc.	206	K8641HB	2,53/pc.	219	K8824/44HB	3,91/pc.	213	K8992HB	2,12/pc.	220
K8544HB	12,96/pc.	206	K8641HFHB	7,84/pc.	220	K8825HB	3,91/pc.	212	K8993HB	3,01/pc.	220
K8545HB	12,96/pc.	206	K8642HB	2,53/pc.	219	K8826HB	3,91/pc.	212	K8994HB	3,01/pc.	220
K8546HB	12,96/pc.	206	K8642HFHB	7,84/pc.	220	K8833HB	2,98/pc.	215	K8995HB	3,01/pc.	220
K8550-11HB	3,78/pc.	210	K8643HB	3,32/pc.	219	K8833KB	2,98/pc.	215	K8996HB	3,01/pc.	220
K8550-12HB	4,70/pc.	210	K8643HFHB	8,81/pc.	220	K8833LB	2,98/pc.	215	KEKD100X40HD	11,41/m	221
K8550-13HB	5,89/pc.	210	K8644HB	3,32/pc.	219	K8834HB	2,72/pc.	215	KEKD120X40HD	13,49/m	221
K8551HB	18,60/pc.	207	K8644HFHB	8,81/pc.	220	K8834KB	2,72/pc.	215	KEKD80X40HD	9,68/m	220
K8552HB	18,60/pc.	207	K8645HB	3,32/pc.	219	K8834LB	2,72/pc.	215	KEKD80X40HFHD	29,74/m	221
K8553HB	18,60/pc.	207	K8645HFHB	8,81/pc.	220	K8843HB	3,31/pc.	215	KEKE100X60HD	15,22/m	207
K8554HB	17,65/pc.	207	K8646HB	3,32/pc.	219	K8843KB	3,31/pc.	215	KEKE140X60HD	22,47/m	208
K8555HB	17,65/pc.	207	K8646HFHB	8,81/pc.	220	K8843LB	3,31/pc.	215	KEKE180X60HD	27,66/m	209
K8556HB	17,65/pc.	207	K8651HB	2,96/pc.	220	K8844HB	3,14/pc.	215	KEKE60X60HD	10,38/m	206
K8560-11HB	4,28/pc.	210	K8652HB	2,96/pc.	220	K8844KB	3,14/pc.	215	KKPEKEHB	5,33/pc.	210
K8560-12HB	5,54/pc.	210	K8653HB	4,02/pc.	220	K8844LB	3,14/pc.	215	KKPPKHB	5,31/pc.	205
K8560-13HB	7,31/pc.	210	K8653RHB	4,02/pc.	220	K8855/3HB	2,12/pc.	214	KKPPKHFHB	7,13/pc.	205
K8561HB	19,82/pc.	208	K8654HB	4,02/pc.	220	K8855HB	2,12/pc.	214	KKSK100PO	70,81/pc.	138
K8562HB	19,82/pc.	208	K8654RHB	4,02/pc.	220	K8856HB	2,12/pc.	214	KKSK1252P06	95,88/pc.	138
K8563HB	34,91/pc.	208	K8655HB	4,02/pc.	220	K8861LHB	3,82/pc.	211	KKSK125DPO	104,80/pc.	139
K8564HB	19,82/pc.	208	K8656HB	4,02/pc.	220	K8861LI1	8,24/pc.	211	KKSK125P010	89,16/pc.	138
K8565HB	19,82/pc.	208	K8671HB	1,01/pc.	217	K8861LI2	8,24/pc.	211	KKSK125P06P	103,32/pc.	139
K8566HB	19,82/pc.	208	K8672HB	1,01/pc.	217	K8861LSD	8,24/pc.	211	KKSK1752P010	122,92/pc.	138
K8571HB	22,67/pc.	209	K8673HB	1,50/pc.	217	K8861PHB	3,82/pc.	211	KKSK175DPO	137,68/pc.	139
K8572HB	22,67/pc.	209	K8674HB	1,50/pc.	217	K8861PI1	8,24/pc.	211	KKSK175P010P	134,50/pc.	139
K8573HB	37,77/pc.	209	K8675HB	1,50/pc.	217	K8861PI2	8,24/pc.	211	KKSK175P016	122,92/pc.	138
K8574HB	22,67/pc.	209	K8676HB	1,50/pc.	217	K8861PSD	8,24/pc.	211	KL-42W	188,54/pc.	215
K8575HB	22,67/pc.	209	K8681HB	0,80/pc.	216	K8865HB	3,82/pc.	211	KLH15X10HD	1,00/m	216
K8576HB	22,67/pc.	209	K8682HB	0,80/pc.	216	K8865I1	8,24/pc.	211	KLH15X10P2	1,86/m	216
K8581HB	6,28/pc.	221	K8683HB	1,19/pc.	216	K8865I2	8,24/pc.	211	KLH60X40HD	7,95/m	220
K8582HB	6,28/pc.	221	K8684HB	1,19/pc.	216	K8865SD	4,22/pc.	211	KLHD17X17HD	1,39/m	217
K8583HB	9,42/pc.	221	K8685HB	1,19/pc.	216	K8866HB	3,82/pc.	211	KLHD17X17P2	2,11/m	217
K8584/EKDHB	9,42/pc.	221	K8686HB	1,19/pc.	216	K8866I1	8,24/pc.	211	KLHD20X10HD	1,27/m	217
K8584HB	9,42/pc.	221	K8691HB	1,11/pc.	218	K8866I2	8,24/pc.	211	KLHD20X10HFHD	4,49/m	217
K8585HB	9,42/pc.	221	K8692HB	1,11/pc.	218	K8866SD	4,22/pc.	211	KLHD20X10P2	2,21/m	217
K8586HB	9,42/pc.	221	K8693HB	1,71/pc.	218	K8873HB	3,89/pc.	215	KLHD20X20HD	1,72/m	217
K8601HB	1,11/pc.	219	K8694HB	1,71/pc.	218	K8873KB	3,89/pc.	215	KLHD20X20HFHD	6,91/m	218
K8602HB	1,11/pc.	219	K8695HB	1,71/pc.	218	K8873LB	3,89/pc.	215	KLHD20X20I1	16,00/m	217
K8603HB	1,69/pc.	219	K8696HB	1,71/pc.	218	K8874HB	3,47/pc.	215	KLHD20X20I2	16,00/m	217
K8604HB	1,69/pc.	219	K8711HB	1,72/pc.	216	K8874KB	3,47/pc.	215	KLHD20X20P2	2,94/m	217
K8605HB	1,69/pc.	219	K8712/2HB	2,01/pc.	216	K8874LB	3,47/pc.	215	KLHD20X20SD	2,14/m	217
K8606HB	1,69/pc.	219	K8713/2HB	2,01/pc.	216	K8911HB	1,13/pc.	218	KLHD20X20TD	2,14/m	217
K8621HB	1,07/pc.	217	K8714HB	1,72/pc.	216	K8912HB	1,13/pc.	218	KLHD25X15HD	1,70/m	218
K8621HFHB	3,53/pc.	218	K8715HB	2,01/pc.	216	K8913HB	1,62/pc.	218	KLHD25X15P2	2,94/m	218

Index

référence	prix en €	page	référence	prix en €	page	référence	prix en €	page	référence	prix en €	page
KLHD25X20HD	2,08/m	218	KPK140X70DHD	29,14/m	202	TB1010-1	53,15/m	181	TBC135-3	40,87/pc.	184
KLHD25X20P2	3,32/m	218	KPK160X65DHD	38,84/m	199	TB1010-3	53,15/m	181	TBC135-3	40,87/pc.	185
KLHD30X25HD	2,34/m	218	KPK170X70DHD	35,35/m	203	TB1032-3	60,62/m	193	TBC135-3	40,87/pc.	186
KLHD30X25P2	3,47/m	218	KPK210X70DHD	50,55/m	200	TB1040-1	57,46/m	183	TBC170-1	43,34/pc.	187
KLHD32X15HD	1,98/m	219	KPK90X55DHD	16,39/m	197	TB1040-3	57,46/m	183	TBC170-1	43,34/pc.	188
KLHD32X15P2	3,29/m	219	KPK90X55DHFHD	44,25/m	197	TB1310-1	54,88/m	184	TBC170-3	43,34/pc.	187
KLHD40X20HD	2,70/m	219	KPKS70/60	10,34/m	204	TB1310-3	54,88/m	184	TBC170-3	43,34/pc.	188
KLHD40X20HFHD	11,41/m	219	KPKS70/60	10,34/m	210	TB1340-1	60,87/m	186	TBC220-1	45,93/pc.	189
KLHD40X20I1	18,60/m	219	KPLSK	5,00/pc.	204	TB1340-3	60,87/m	186	TBC220-1	45,93/pc.	190
KLHD40X20I2	18,60/m	219	KPN80X25ZHB	7,77/pc.	212	TB1710-1	69,57/m	187	TBC220-3	45,93/pc.	189
KLHD40X20P2	4,22/m	219	KPN80X25HB	7,52/pc.	212	TB1710-3	69,57/m	187	TBC220-3	45,93/pc.	190
KLHD40X20SD	4,13/m	219	KPNEKES	48,47/pc.	210	TB1740-1	70,96/m	188	TBD100-1	11,76/pc.	194
KLHD40X20TD	4,13/m	219	KPNLP352ZHB	6,57/pc.	211	TB1740-3	70,96/m	188	TBD100-3	11,76/pc.	194
KLHD40X40HD	4,33/m	219	KPNLP352ZI1	12,71/pc.	211	TB2210-1	93,84/m	189	TBD180-1	13,32/pc.	194
KLHD40X40HFHD	16,95/m	220	KPNLP352ZI2	12,71/pc.	211	TB2210-3	93,84/m	189	TBD180-3	13,32/pc.	194
KLHD40X40SD	8,40/m	219	KPNLP352ZSD	10,42/pc.	211	TB2240-1	116,77/m	190	TBD30-1	10,43/pc.	193
KLHD40X40TD	8,40/m	219	KPNPKS	48,47/pc.	205	TB2240-3	116,77/m	190	TBD30-3	10,43/pc.	193
KLHD50X20/1HD	3,74/m	220	KPSK1HB	3,65/pc.	204	TB45-1	11,93/m	183	TBD65-1	10,55/pc.	193
KLHD50X20/2HD	4,02/m	220	KQP45X45CBB	13,49/pc.	205	TB45-1	11,93/m	186	TBD65-3	10,55/pc.	193
KLHD50X20HD	3,52/m	220	KQP45X45CHB	12,52/pc.	205	TB45-1	11,93/m	188	TBE1	10,26/pc.	192
KLO35HD	5,41/m	215	KRK-0VK20LA	10,67/pc.	222	TB45-1	11,93/m	190	TBE100	12,84/pc.	192
KLO35KD	7,38/m	215	KRK-0VK30LB	11,21/pc.	222	TB45-3	11,93/m	183	TBE125	15,63/pc.	192
KLO35LD	7,38/m	215	KRK-0VK40LB	12,97/pc.	222	TB45-3	11,93/m	186	TBE20-1	11,25/m	192
KLO35P2	5,70/m	215	KRK-ST12H20	2,62/m	222	TB45-3	11,93/m	188	TBE20-3	11,25/m	192
KLO50HD	7,71/m	215	KRK-ST22H25	7,04/m	222	TB45-3	11,93/m	190	TBE25	6,74/pc.	192
KLO50KD	7,71/m	215	KRK-ST6H25	1,62/m	222	TB80-1	16,71/m	181	TBE3	3,34/pc.	192
KLO50LD	7,71/m	215	KRK100X60LD	17,21/m	222	TB80-1	16,71/m	184	TBE50	8,07/pc.	192
KLO50P2	8,65/m	215	KRK30X30LD	7,40/m	222	TB80-1	16,71/m	187	TBE75	10,38/pc.	192
KLO75HD	10,15/m	215	KRK30X40LD	8,72/m	222	TB80-1	16,71/m	188	TBF1	6,23/pc.	191
KLO75KD	10,15/m	215	KRK37.5X37.5HFLD	17,36/m	222	TB80-1	16,71/m	189	TBF11	1,44/pc.	191
KLO75LD	10,15/m	215	KRK37.5X50HFLD	22,16/m	222	TB80-1	16,71/m	190	TBF2	14,12/pc.	191
KLO75P2	12,64/m	215	KRK40X60LD	8,88/m	222	TB80-1	16,71/m	194	TBJ1	4,73/pc.	191
KLP35HD	9,24/m	211	KRK40X80LD	10,91/m	222	TB80-1	16,71/m	194	TBJ8	0,51/pc.	192
KLP35I1	18,80/m	211	KRK50X50HFLD	23,84/m	222	TB80-3	16,71/m	181	TBK1	1,55/pc.	192
KLP35I2	18,80/m	211	KRK60X60LD	11,53/m	222	TB80-3	16,71/m	184	TBL10-1	8,30/pc.	181
KLP35SD	13,59/m	211	KRK60X80LD	12,85/m	222	TB80-3	16,71/m	187	TBL10-1	8,30/pc.	183
KLP35TD	13,59/m	211	KRK80X60LD	16,12/m	222	TB80-3	16,71/m	188	TBL10-3	8,30/pc.	181
KLP80X25HD	11,56/m	212	KSB6.3X35POGMT	66,87/sac	137	TB80-3	16,71/m	189	TBL10-3	8,30/pc.	182
KLPK80X25HD	14,80/m	212	KSD2S	2,03/pc.	136	TB80-3	16,71/m	190	TBL10-3	8,30/pc.	183
KLR30HB	11,88/m	214	KSK40X20S	25,10/m	204	TB80-3	16,71/m	193	TBL13-1	8,30/pc.	184
KLV11X10HD	0,97/m	216	KSK40X20S	25,10/m	210	TB80-3	16,71/m	194	TBL13-1	8,30/pc.	186
KLV11X10P2	1,83/m	216	KSK40X33S	28,13/m	204	TB80-3	16,71/m	194	TBL13-3	8,30/pc.	184
KLV18X13HD	1,34/m	216	KSK40X33S	28,13/m	210	TBA10-1	59,36/m	194	TBL13-3	8,30/pc.	185
KLV18X13P2	2,38/m	216	KVK20	323,40/pc.	215	TBA10-3	59,36/m	194	TBL13-3	8,30/pc.	186
KLV18X13SD	1,80/m	216	PDC100-3	4,74/pc.	182	TBA18-1	104,61/m	194	TBL17-1	8,30/pc.	187
KLV18X13TD	1,80/m	216	PDC135-3	5,03/pc.	185	TBA18-3	104,61/m	194	TBL17-1	8,30/pc.	188
KLV24X22HD	2,11/m	216	PK1010-3	26,03/m	182	TBA202-1	17,06/m	193	TBL17-3	8,30/pc.	187
KLV24X22P2	3,64/m	216	PK1310-3	33,93/m	185	TBA202-3	17,06/m	193	TBL17-3	8,30/pc.	188
KLV40X15HD	4,17/m	216	PKE100-3	5,44/pc.	182	TBA22-1	11,52/m	193	TBL22-1	8,30/pc.	189
KLV40X15P2	5,30/m	216	PKE135-3	5,71/pc.	185	TBA22-3	11,52/m	193	TBL22-1	8,30/pc.	190
KLZ15X12HD	1,32/m	214	PKJ1	1,89/pc.	182	TBA302-1	32,17/m	193	TBL22-3	8,30/pc.	189
KLZK15X12HD	1,32/m	214	PKJ1	1,89/pc.	185	TBA302-3	32,17/m	193	TBL22-3	8,30/pc.	190
KOKSPLDB	1,89/pc.	121	PROF30-15-1.5-4/GS	5,25/m	120	TBA32-1	12,11/m	193	TBM1	7,19/pc.	191
KOKSPSDB	2,94/pc.	121	PROF30-15-2.0-2/GS	6,58/m	120	TBA32-1	12,11/m	193	TBO100-3	9,11/pc.	181
KPEKD40C	2,94/m	204	PROF41-21-2.0-6/HD	14,38/m	120	TBA32-3	12,11/m	193	TBO100-3	9,11/pc.	182
KPEKD40HFC	7,53/m	204	PROF41-21-2.5-3/HD	18,02/m	120	TBA32-3	12,11/m	193	TBO100-3	9,11/pc.	183
KPEKE60C	6,35/m	204	PROF41-21-2.5-6/HD	18,02/m	120	TBA652-1	42,13/m	193	TBO135-3	9,68/pc.	184
KPEKE60C	6,35/m	210	PROF41-41-2.0-6/HD	21,52/m	120	TBA652-3	42,13/m	193	TBO135-3	9,68/pc.	185
KPEP60/KS	29,40/m	204	PROF41-41-2.5-3/HD	24,46/m	120	TBC100-1	40,87/pc.	181	TBO135-3	9,68/pc.	186
KPEP60/KS	29,40/m	210	PROF41-41-2.5-6/HD	24,46/m	120	TBC100-1	40,87/pc.	183	TBO170-3	9,98/pc.	187
KPEP60HD	12,54/m	204	PROF41-41-2.5-6/RVS316	103,52/m	121	TBC100-3	40,87/pc.	181	TBO170-3	9,98/pc.	188
KPEP60HD	12,54/m	210	PROF41-41-2.5-6/RVS316P	108,18/m	121	TBC100-3	40,87/pc.	182	TBO220-3	10,38/pc.	189
KPK110X70DHD	24,03/m	201	PROFD41-21-2.0-6/HD	32,12/m	121	TBC100-3	40,87/pc.	183	TBO220-3	10,38/pc.	190
KPK110X70DHFHD	65,22/m	201	PROFD41-41-2.5-6/HD	54,76/m	121	TBC135-1	40,87/pc.	184	TBP100-1	13,60/pc.	181
KPK120X55DHD	28,34/m	198	SNA 6x30/5	168,66/bt.	154	TBC135-1	40,87/pc.	186	TBP100-1	13,60/pc.	183

Conditions générales de ventes

Toutes nos ventes sont conclues aux conditions suivantes, auxquelles il ne pourra être dérogé que par conventions expresses et écrites.

1. Nos offres sont faites sans engagement et sauf vente.
2. Tous les marchés sont considérés comme conclus à Deinze.
3. Sauf dispositions contraires expressément acceptées par nous, nos prix s'entendent toujours sans montage, ni pose, ni ajustage.
4. Les clauses figurant dans les correspondances et commandes de l'acheteur et qui dérogent aux présentes conditions ne peuvent être considérées comme acceptées par nous que si nous avons donné expressément notre accord écrit sur le contenu.
5. Les délais de livraison, de fournitures ou d'exécution ne constituent pas un engagement formel de notre part mais ne sont donnés qu'à titre indicatif; un retard de livraison de fournitures ou d'exécution ne peut donner lieu à dommages et intérêts que pour autant que pareille sanction ait été spécialement convenue et que nous l'ayons admise expressément et par écrit.
Même dans cette éventualité, nous serions libérés par tous cas de force majeure, étant entendu que notamment les cas suivants sont conventionnellement à considérer comme tels: grèves, lock-out, panne de courant, d'eau, accident grave aux usines, machines, ateliers et magasins, troubles populaires, émeutes, mobilisations, guerre, gel, inondations, absence sur le marché de matières, etc. Cette énonciation est exemplative et non limitative. Le cas de force majeure ne peut entraîner la résiliation des marchés de la part de l'acheteur, ni le droit de se pourvoir ailleurs pour notre compte, pas plus que l'obligation pour nous de fournir en remplacement des produits d'une autre firme.
6. Les dessins que nous communiquons à nos clients, restent notre propriété et ne peuvent en aucun cas être transmis à

destiers, soit pour leur examen, soit pour leur copie.

Les gravures, photographies et dessins de nos catalogues ne sont donnés qu'à titre indicatif. Les perfectionnements constants que nous apportons à nos fabrications ne nous permettent pas de maintenir l'exécution suivant les cotes mentionnées sur nos plans et dessins. Dès lors les cotes indiquées ne nous engagent pas.

7. Nos marchandises voyagent aux risques et périls exclusifs du destinataire même si nous en assumons le transport. En cas d'avaries ou de manquants, l'acheteur devra adresser une réclamation au transporteur, ou la faire adresser par le destinataire, même si le prix de la marchandise avait été fixé pour livraison franco.
Pour les fournitures «rendues sur chantier» nos camions ne devons pas quitter les chemins carrossables. Les frais résultant d'un stationnement ou déchargement supérieur au délai en usage seront à charge des clients.
8. Les marchandises sont toujours vendues «agrées avant expédition» même lorsque les prix comprennent le transport ou sont fixés à destination ou pose ou placement compris. L'acheteur à toujours le droit de les faire vérifier à ses frais avant l'enlèvement ou l'expédition. Notre acceptation de la commande constitue par elle-même une invitation expresse à venir faire la réception de la marchandise avant départ. L'acheteur est tenu de s'informer lui-même des dates de mise à disposition ou de départ ou d'expédition afin d'exercer en temps utile son droit de contrôle. Faute de l'exercer dans les dites conditions, la marchandise est considérée comme agréée. Par voie de conséquence toute réclamation ultérieure est non recevable.
9. Les réclamations au sujet du contenu ou du libellé des factures doivent se faire dans la huitaine de leur réception.
10. Les paiements doivent être effectués à Deinze. Nos conditions s'entendent nettes, paie-

ment vingt pour cent à la commande, le solde à la mise à disposition de la marchandise. Lorsque nos factures ne sont pas réglées à l'échéance prévue, nous nous réservons le droit, sans nouvel avertissement, de faire présenter des effets par nos banquiers, tous frais d'escompte, d'encaissement, etc., à charge de nos clients. Le jour d'enlèvement ou d'expédition de la marchandise sert de base à la fixation des échéances, même en cas de vente franco. Au cas où il aura été convenu que l'acheteur acceptera une ou plusieurs traites, le défaut de retour de celles-ci dans les quatre jours de l'envoi à l'acceptation, rendra leur montant total immédiatement exigible.

Les réclamations ne justifient pas le non-paiement.

L'existence d'une réclamation ou d'une contestation permet uniquement le paiement sous réserve. Le défaut de paiement à l'échéance entraînera de plein droit et sans mise en demeure préalable la majoration du montant de la facture de 15%, sans que cette majoration puisse être inférieure à 25 Euro.

Si des retards surviennent dans le paiement des acomptes prévus, nous nous réservons la faculté d'arrêter les travaux et d'annuler la commande, à notre choix, et sous toutes réserves de droit.

11. Nous nous réservons le droit, même après exécution partielle d'une marché, d'exiger de nos co-contractants une garantie de bonne exécution de leurs propres engagements. Le refus de satisfaire à pareille demande même amiable, nous fonderait à notre choix à surseoir à l'exécution du surplus ou à considérer le marché soit comme résolu, soit comme résilié aux torts et griefs du co-contractant et à tirer de cette résolution toutes conséquences de droit.
12. Nos prix sont établis sur base des conditions économiques, sociales et fiscales en vigueur au moment de notre offre. Toutes modifications à ces conditions, qui surviendraient après la date de notre offre, entraîneraient la révision de nos prix. Toute taxe mise ou venant à être mise sur la vente,

la fourniture, la fabrication ou le transport de nos marchandises est toujours à charge de l'acheteur.

13. Sous réserve expresse de nos droits à des dommages et intérêts, il nous est conventionnellement reconnu celui d'annuler les commandes et de considérer le marché comme-résilié même en cours d'exécution et sans sommation préalable - si après la conclusion du marché, l'acheteur néglige d'enlever la marchandise dans les délais fixés, de payer aux dates convenues, d'honorer une traite acceptée, d'exécuter chacune de ses obligations. Toute somme due à terme deviendra dans ce cas immédiatement exigible. Nous nous réservons le droit de résiliation du marché, également en cas de décès, faillite, suspension de paiement, protêt et dissolution de la société ou de la firme acheteuse.
14. Les offres faites ou les engagements pris par les agents et employés de notre firme ne nous lient effectivement qu'après ratification de notre part. Agents et commissionnaires ne sont pas qualifiés pour percevoir le montant des factures et nous ne reconnaissons comme pièce de décharge que celle qui porte notre signature.
15. Les tribunaux de Gand sont seuls compétents en cas de litige, même en cas d'appel en garantie ou de pluralité des défendeurs. La création de promesses ou traites, les acceptations de règlement, envois franco, n'opèrent ni vocation, ni dérogation à cette clause attributive de juridiction.
16. Sans préjudice des dispositions des articles 7 et 8 les marchandises restent la propriété du vendeur jusqu'au paiement intégral du prix.
17. Transport:
 - franc de port à partir de 500 Euro;
 - pour livraison à une autre adresse qu'adresse de livraison habituelle: prix départ usine.



DUCTEL[®]



WIBE



STAGOBEL ELECTRO est l'importateur exclusif de matériel électrique pour l'électro-installateur et l'industrie. Le vaste programme de produits de haute qualité comprend des systèmes de support de câbles économiques pour bâtiments industriels et tertiaires, le matériel de contact CEE, la protection contre la foudre, des stations de recharge pour e-mobility, des solutions innovatrices pour la gestion des bâtiments et la domotique.



Zone 1 - De Prijckels | Karrewegstraat 50 | B-9800 Deinze | T 09 381 85 00 | info@stagobel.be | www.stagobel.be



www.facebook.com/StagobelElectro



www.linkedin.com/company/stagobel-electro



www.youtube.com